



EVOTECH®
P E R F O R M A N C E

Kawasaki Z650/Ninja 650

Tail Tidy

Installation Instructions



Product No: PRN013661

Kit Contents

- (A) 1 x Main Bracket
- (B) 1 x Indicator Bracket
- (C) 1 x Light Bracket
- (D) 1 x Reflector Kit
- (E) 1 x Retro Light
- (F) 1 x Light Connector
- (G) 2 x M6 x 20 Button Head Bolt
- (H) 2 x M4 Special Washer
- (I) 2 x Thread Caps
- (J) 2 x M4 Nuts
- (K) 4 x M4 x 8 Button Head Bolts
- (L) 4 x M6 Flange Nuts

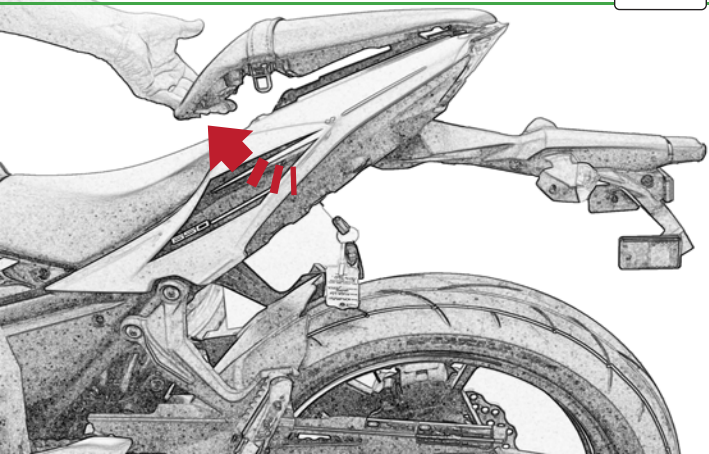

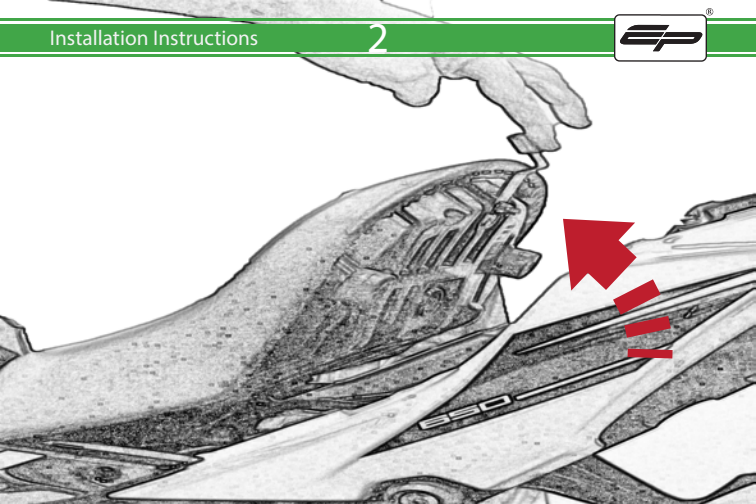

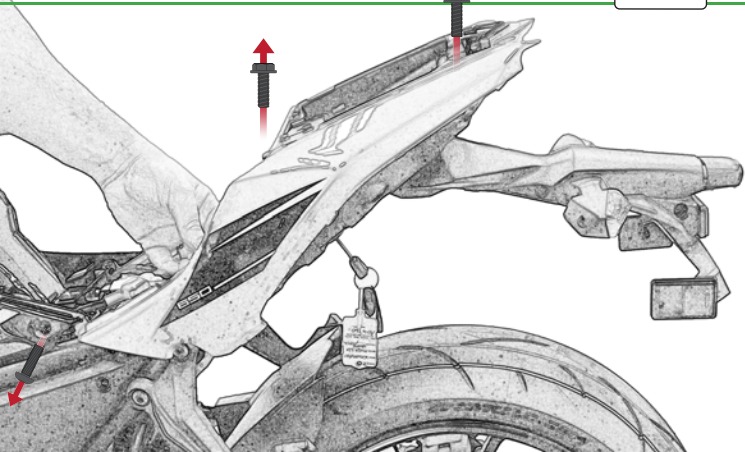

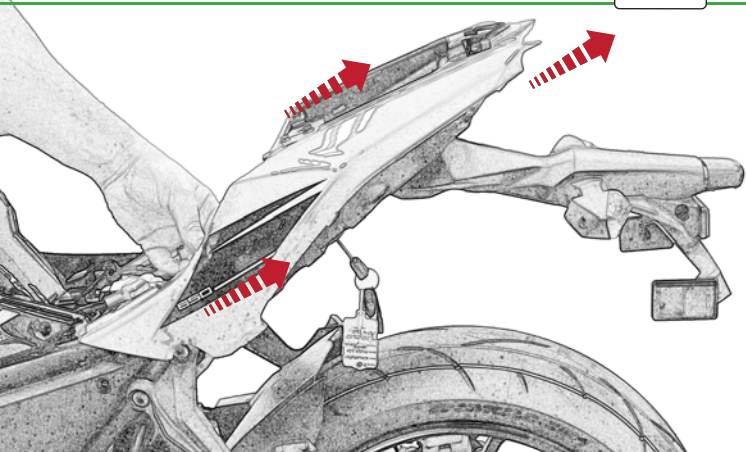

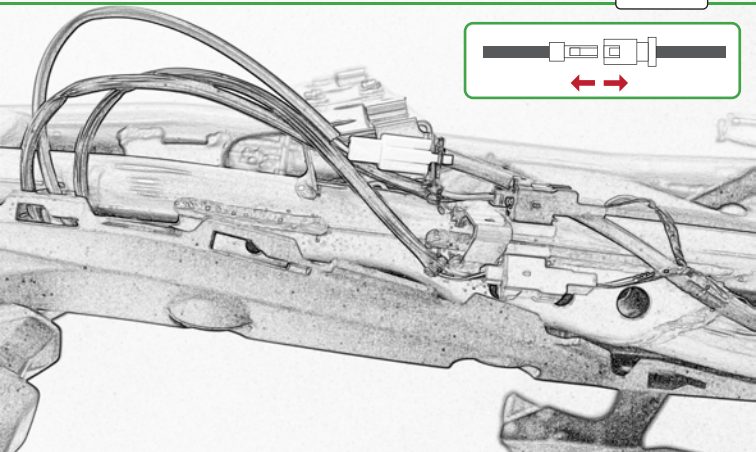
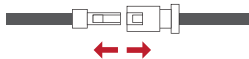

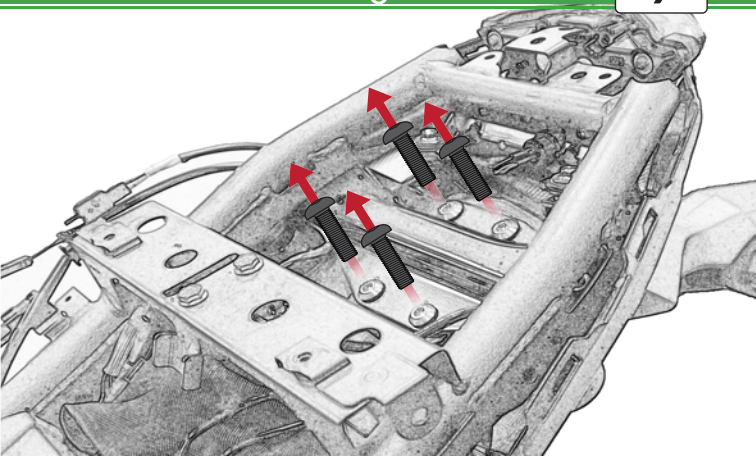

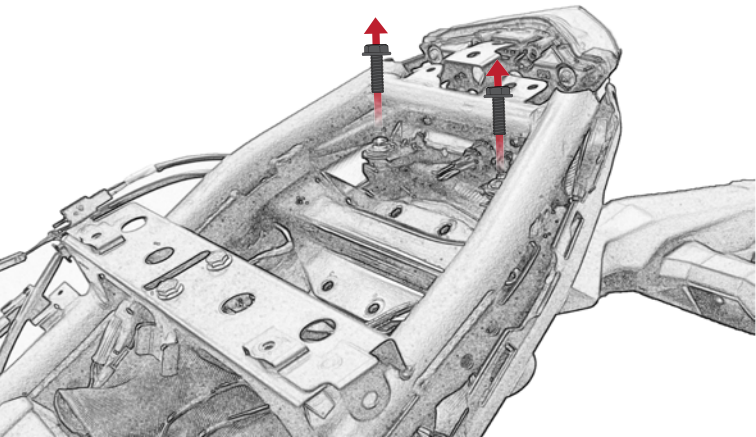

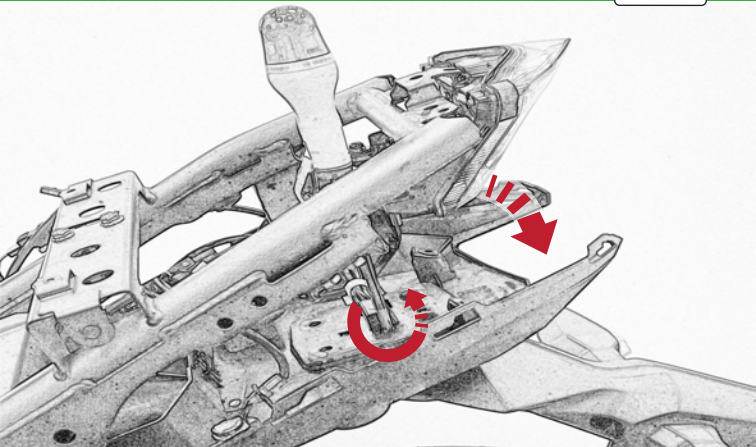

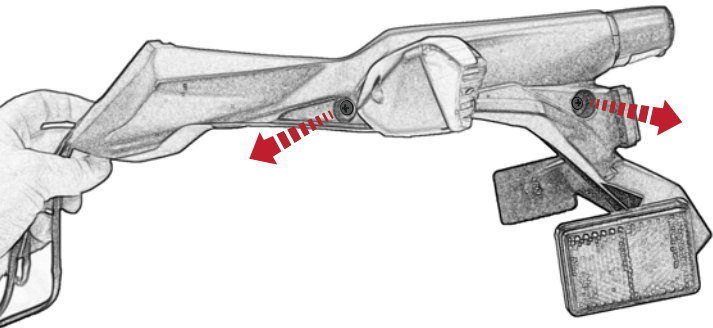

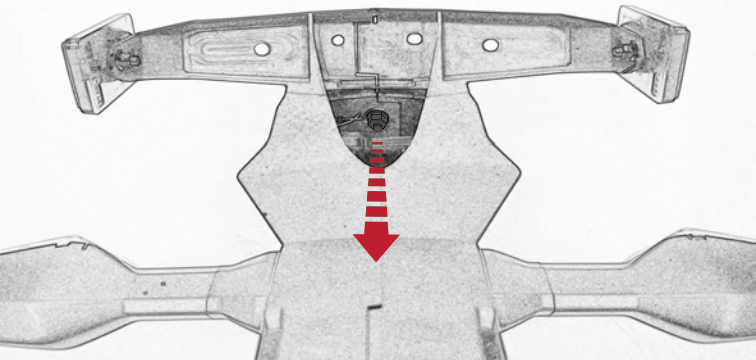

Repeat
Both Sides

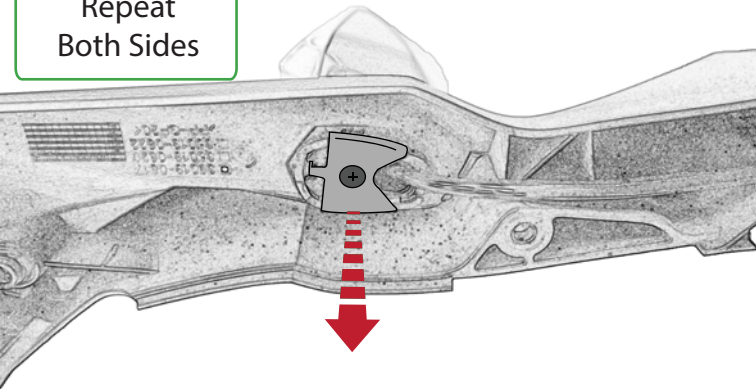

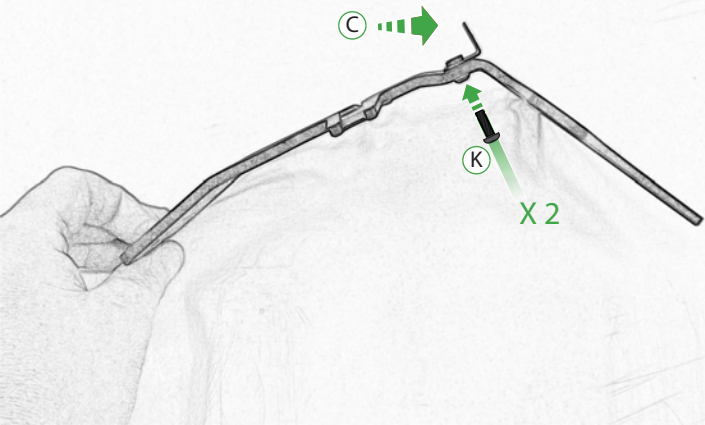

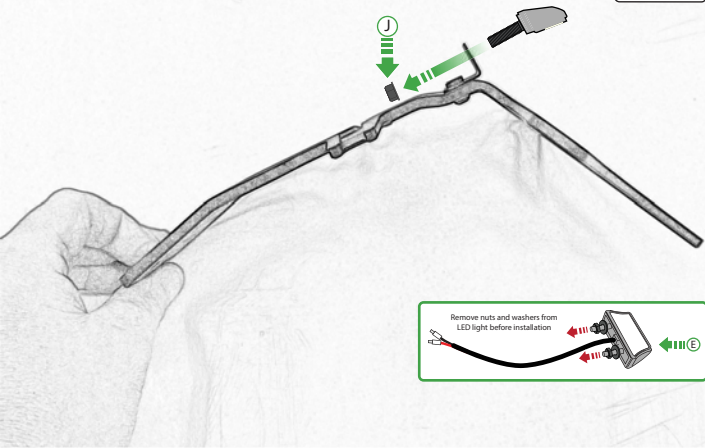

Remove nuts and washers from
LED light before installation



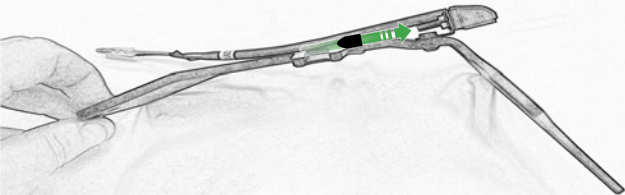
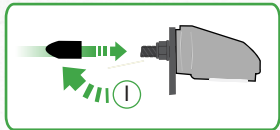

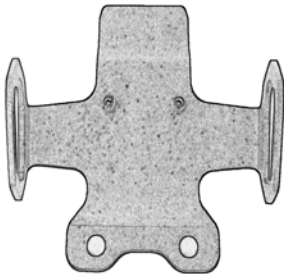

Caution

Ensure indicators are installed
on the correct sides - drain
holes should face down

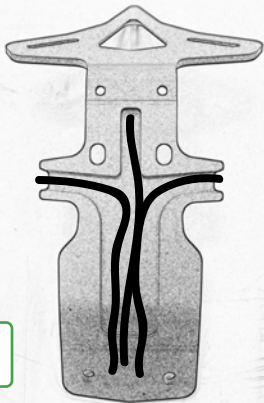

Caution

Run wires neatly down the channel
in both parts ensuring they
do not get trapped or squashed



Caution

Run wires neatly down the channel in both parts ensuring they do not get trapped or squashed

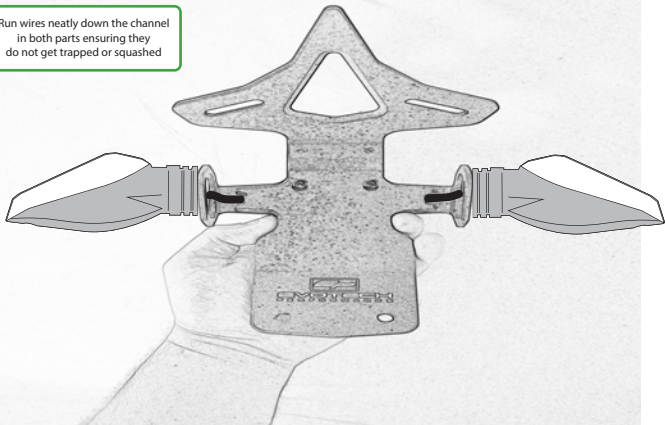

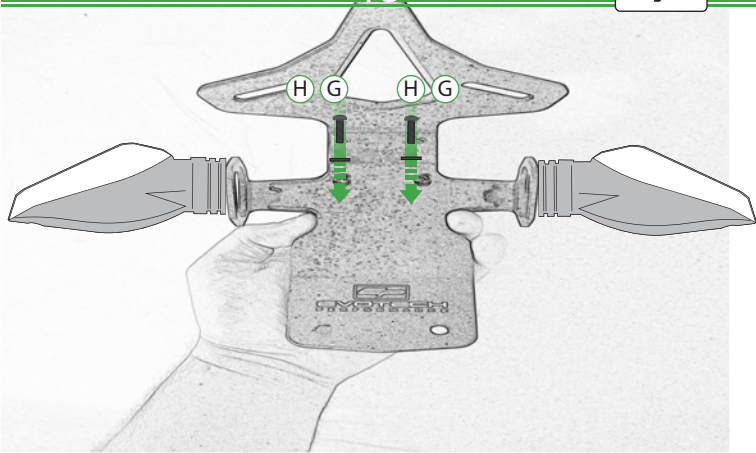

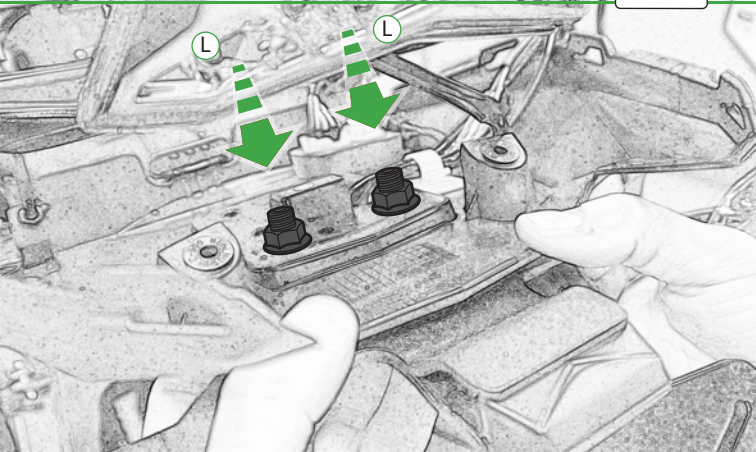

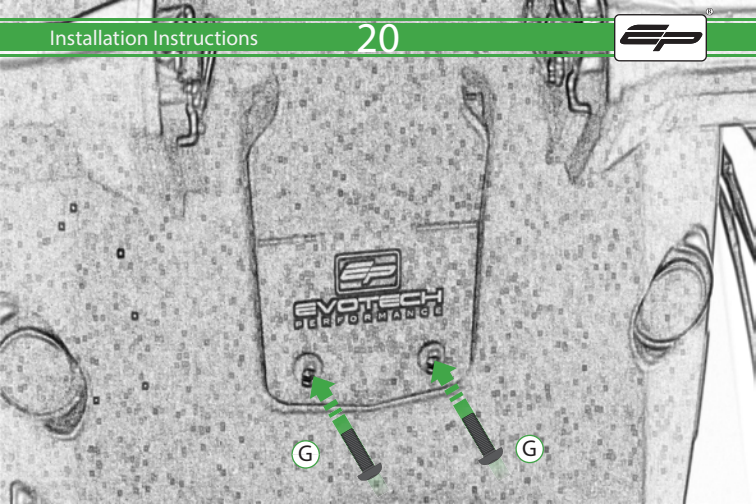

G

G

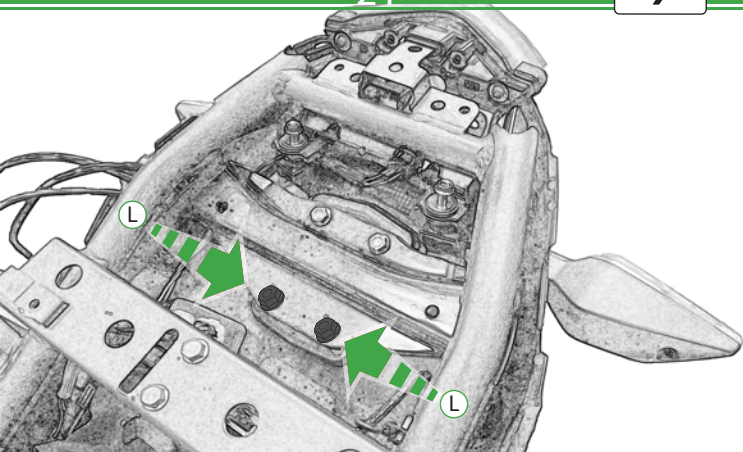

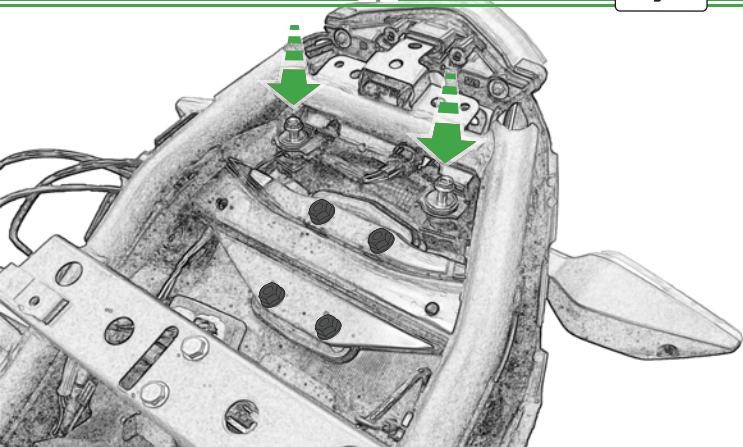

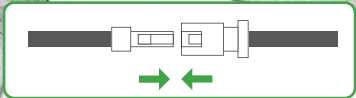
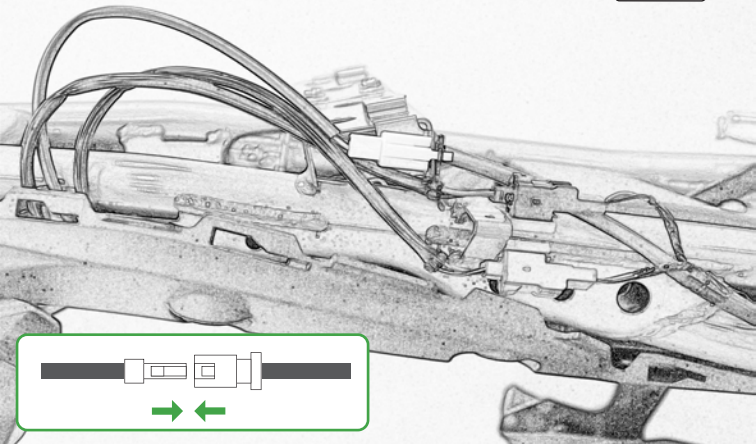

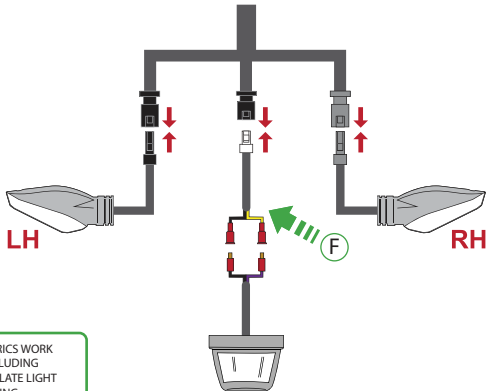

Caution

CHECK ALL ELECTRICS WORK
CORRECTLY, INCLUDING
INDICATORS AND PLATE LIGHT
BEFORE RIDING



Reverse Stages

3 - 1

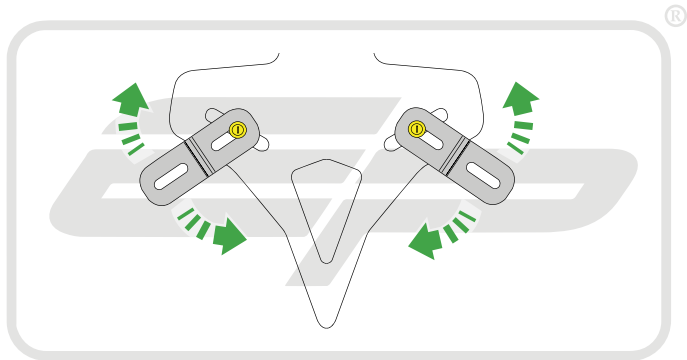

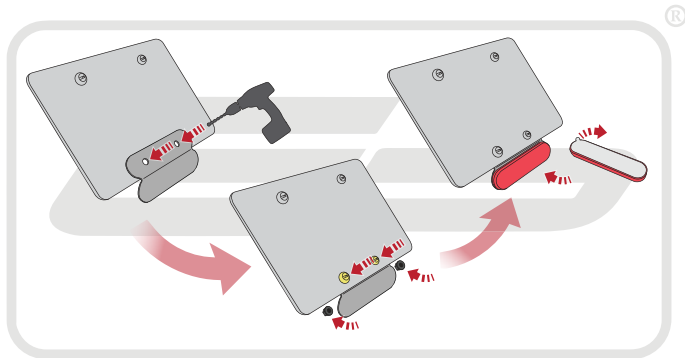



 **ESSENTIAL CHECKS** 

After installation of your tail tidy ensure that the licence plate does not contact the rear tyre when suspension is fully compressed.

Ensure all electrics including indicators, tail light, brake light and licence plate light lights are working correctly before riding the motorcycle.

It is recommended that periodic inspections are made to ensure that all fixings are fully tightened.



EVOTECH®
P E R F O R M A N C E

www.evotech-performance.com