

QUICK-LOCK EVO-Kofferträger Adapterkit GIVI/Kappa Monokey  
QUICK-LOCK EVO Side Carrier Adapter Kit GIVI/Kappa Monokey

**Montagehinweise**

Alle vom Motorrad gelösten Schrauben sind gemäß Herstellerangaben wieder zu montieren, oder mit von SW-MOTECH gelieferten Schrauben zu ersetzen. Falls nicht anderweitig definiert, diese Schrauben nach Tabelle anziehen.

**M6 9,6 Nm**

Gegebenenfalls Schrauben mit flüssiger Schraubensicherung einkleben.

Prüfen Sie nach 50 km alle Verbindungen auf festen Sitz.

SW-MOTECH GmbH & Co. KG  
Ernteweg 8/10  
35282 Rauschenberg  
Germany

Tel. +49 (0) 64 25/8 16 8-00  
Fax +49 (0) 64 25/8 16 8-10

info@sw-motech.com  
www.sw-motech.com

**Mounting Instructions**







SW-MOTECH products should be installed by a qualified, experienced motorcycle technician. If you are unsure of your ability to properly install a product, please have the product installed by your local motorcycle dealer. SW Motech takes no responsibility for damages caused by improper installation.

All screws, bolts and nuts, including all replacement hardware provided by SW-MOTECH, should be tightened to the torque specified in the OEM maintenance manual for your motorcycle. If no torque specifications are provided in the OEM maintenance manual, the following torques may be used:

**M6 9,6 Nm**

All screws, bolts and nuts should be checked after driving the first 50 km to ensure that all are tightened to the proper torque.

Medium strength liquid thread-locker (i.e., "Loctite") should be used to secure all screws, bolts and nuts.

<p>1 Schlossnase GIVI Lock Pin GIVI</p>  <p>KFT.00.117.009</p> <p>Anzahl/Pcs. 2</p>	<p>5 Führungsbolzen Guide Sleeve</p>  <p>schwarz/black</p> <p>KFT.00.117.006</p> <p>Anzahl/Pcs. 4</p>
<p>2 Innensechskant- schraube Hexagon Socket Screw</p>  <p>M6 x 25 DIN 912</p> <p>Anzahl/Pcs. 4</p>	<p>6 Senkkopfschraube Countersunk Screw</p>  <p>schwarz/black</p> <p>M6 x 35 DIN 7991</p> <p>Anzahl/Pcs. 4</p>
<p>3 Unterlegscheibe Washer</p>  <p>A 6,4 DIN 125</p> <p>Anzahl/Pcs. 4</p>	<p>7 Mutter mit Bund, selbstsichernd Lock Nut with Flange</p>  <p>schwarz/black</p> <p>M6 DIN 6927</p> <p>Anzahl/Pcs. 4</p>
<p>4 Vibrationsdämpfer Rubber Element</p>  <p>KFT.00.152.080</p> <p>Anzahl/Pcs. 4</p>	

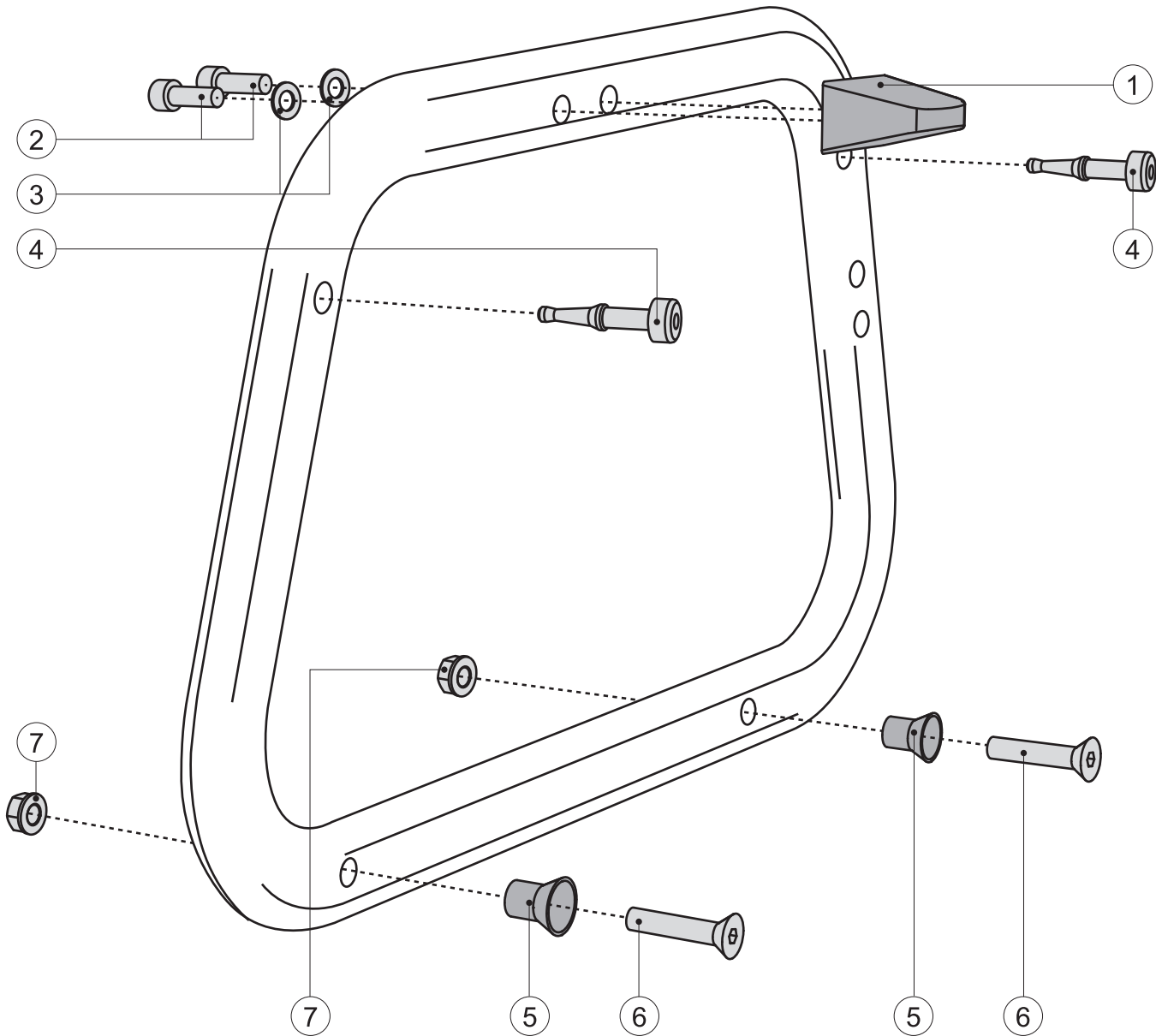

**!** Achtung: Vibrationsdämpfer (4) vor der Montage am EVO-Träger mit Flüssigseife einschmieren, anschließend vorsichtig mit einem kleinen Schlitzschraubendreher wie **Zeichnung I** gezeigt einsetzen und am Endstück festziehen (siehe **Zeichnung II**). Das überstehende Endstück kann nach Montage entfernt werden (siehe **Zeichnung III**).  
**Achtung:** Achten Sie bitte darauf, das mindestens 5mm Material nach dem Abschneiden erhalten bleibt.

Before mounting, lubricate the rubber elements (4) with liquid soap. Then insert the rubber elements (4) carefully with a small screwdriver and pull it through the EVO-Carrier as shown in **drawing I** and **II**. After mounting, cut away the end fitting of the rubber element (4) as shown in **drawing III**.  
**Attention:** Leave at least 5mm material extending beyond the frame.

