

HONDA CMX1100 REBEL '21-

M O U N T I N G I N S T R U C T I O N S

REF 20821

PLACA FRONTAL DE ABS / ABS FRONT PLATE



1 Person



15 min



EASY



ALLEN

Nº 3
Nº 6



ID	PIEZA/PART	DESCRIPCIÓN	DESCRIPTION	QTY	REF
1		Placa frontal ABS	ABS front plate	1	10526C/JM3
2		Soporte derecho (R)	Right support (R)	1	SOP2P3-R--20821
3		Soporte izquierdo (L)	Left support (L)	1	SOP2P3-L--20821
4		Tornillo Allen M5x20 Ø11 ISO 7380	M5x20 Ø11 ISO 7380 Allen screw	4	TORNI-I7380-730
5		Casquillo Ø8,5x Ø13x 6	Ø8,5x Ø13x 6 arrowhead	4	CASQUI-----776
6		Silentblock M5	M5 silentblock	2	SILENBTM5-046/1
7		Arandela de nylon M5x1	M5x1 nylon washer	2	ARNV00000000245
8		Tornillo Allen M5x16 Ø11 ISO 7380	M5x16 Ø11 ISO 7380 Allen screw	2	TORNI-I7380-493
9		Tapón tornillo M5	M5 screw cap	2	TAPON-----85
10		Separador de silicona Ø8 x2	Ø8 x2 silicon spacers	2	ADHESI-GT-D8---
11		Kit adhesivos	Stickers set	1	10535

HONDA CMX1100 REBEL '21-

INSTRUCCIONES DE MONTAJE - MOUNTING INSTRUCTIONS - MONTAGEANLEITUNG

1

DISASSEMBLY
DESMONTAJE

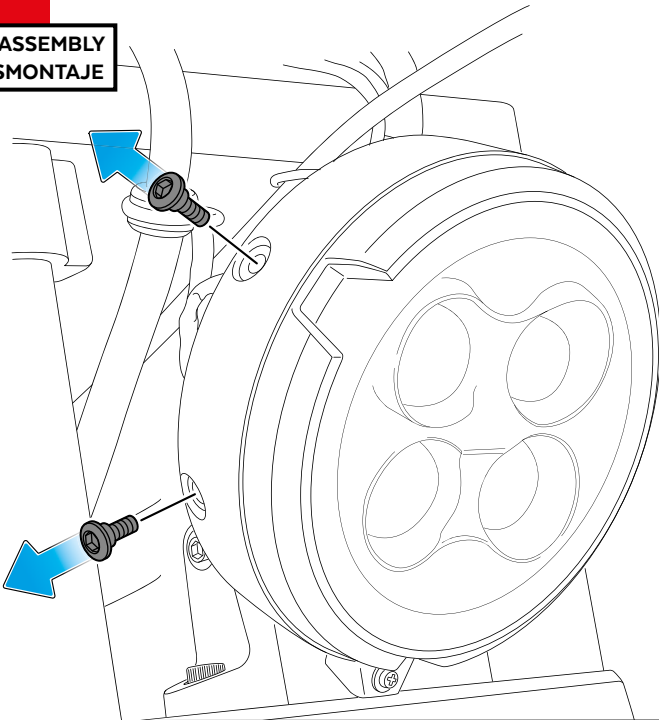

2

ASSEMBLY
MONTAJE

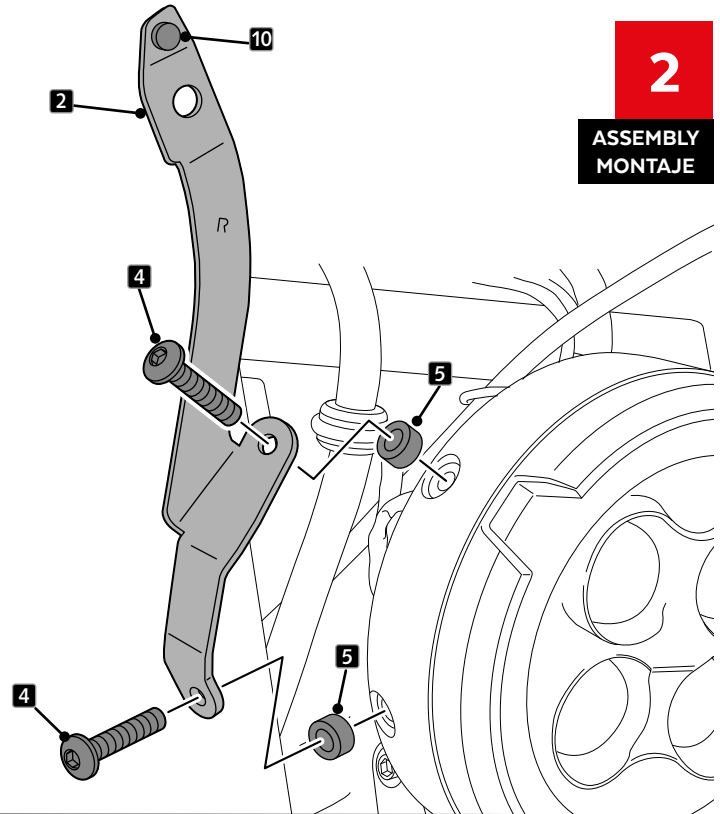

3

DISASSEMBLY
DESMONTAJE

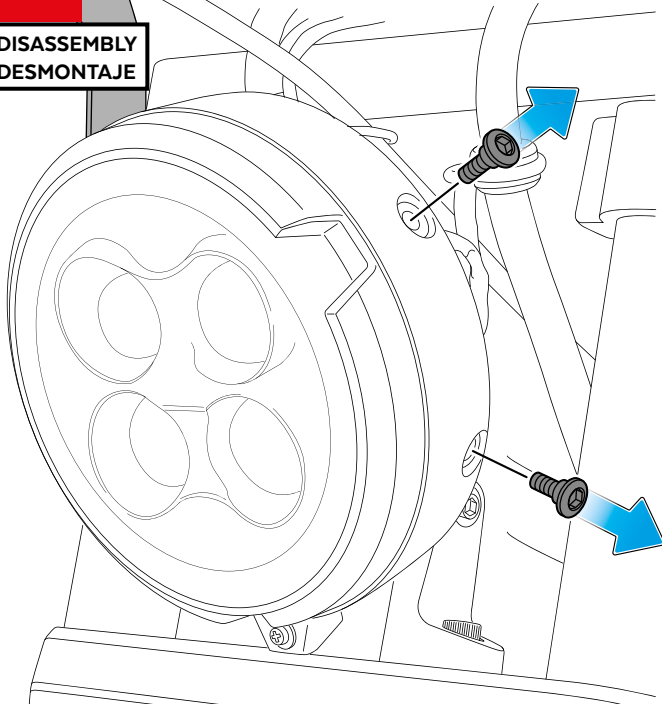

4

ASSEMBLY
MONTAJE

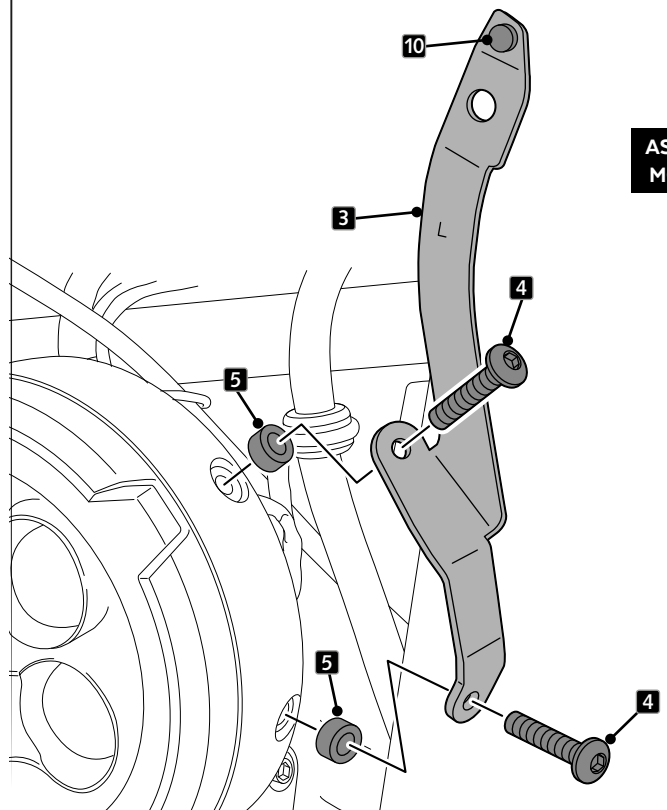

HONDA CMX1100 REBEL '21-

INSTRUCCIONES DE MONTAJE - MOUNTING INSTRUCTIONS - MONTAGEANLEITUNG

5

ASSEMBLY
MONTAJE

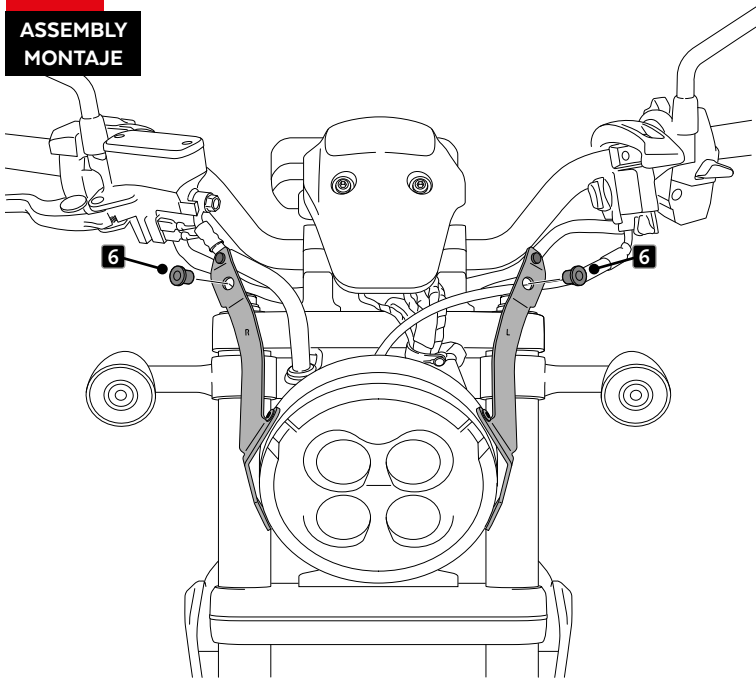

6

ASSEMBLY
MONTAJE

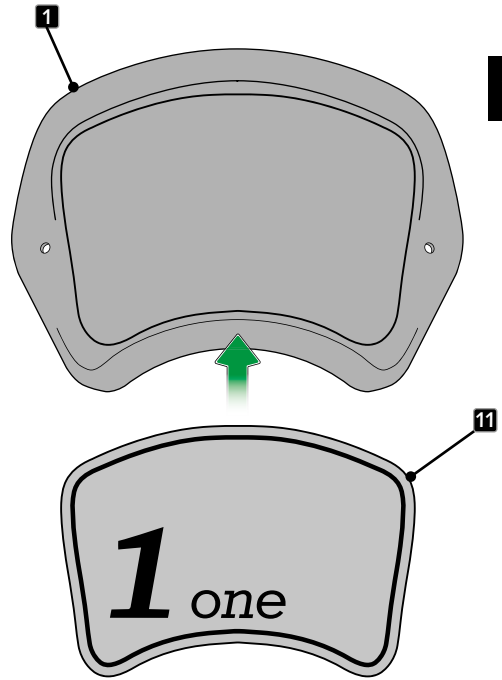

7

ASSEMBLY
MONTAJE

