

YAMAHA YZF-R7 '22-

M O U N T I N G I N S T R U C T I O N S

VIDEO

REF 21223

DOWNFORCE RACE SIDE SPOILERS



1 Person



30 min



EASY



PHILLIPS
SCREWDRIVER

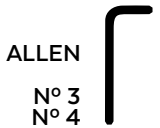

ALLEN
Nº 3
Nº 4

1

DISASSEMBLY
DESMONTAJE

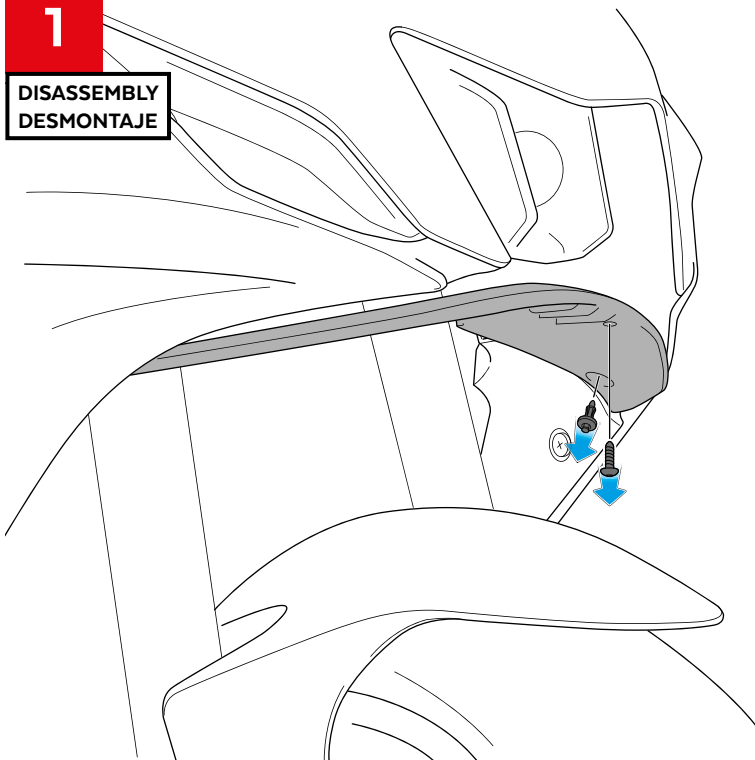

2

DISASSEMBLY
DESMONTAJE

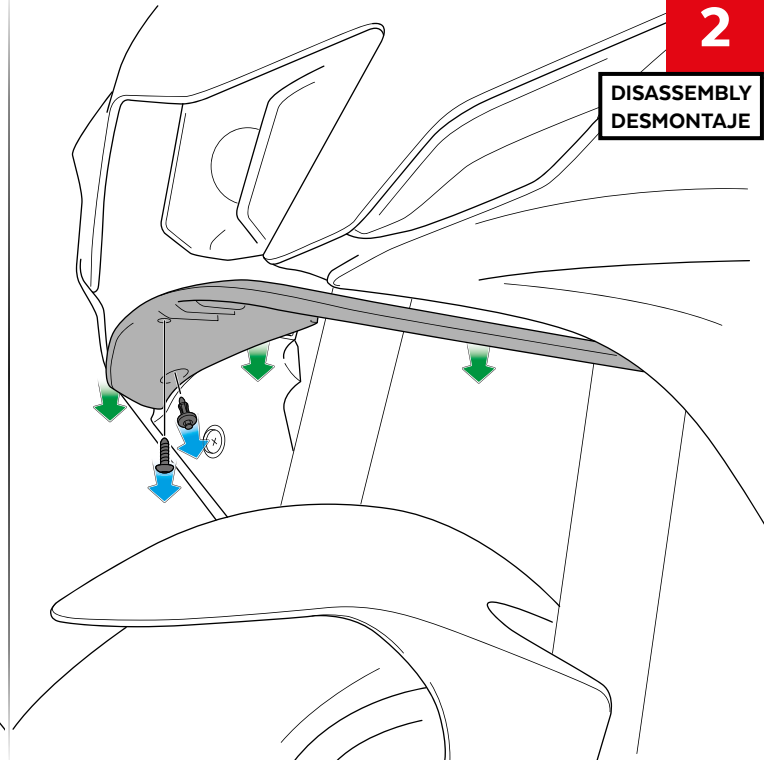

YAMAHA YZF-R7 '22-

INSTRUCCIONES DE MONTAJE - MOUNTING INSTRUCTIONS - MONTAGEANLEITUNG

3

**ASSEMBLY
MONTAJE**

Se muestra el montaje del lado izquierdo a modo de ejemplo, realizar los mismos pasos para el montaje del lado derecho.
The left side assembly is shown as an example, so the same steps can be performed for the right side assembly.

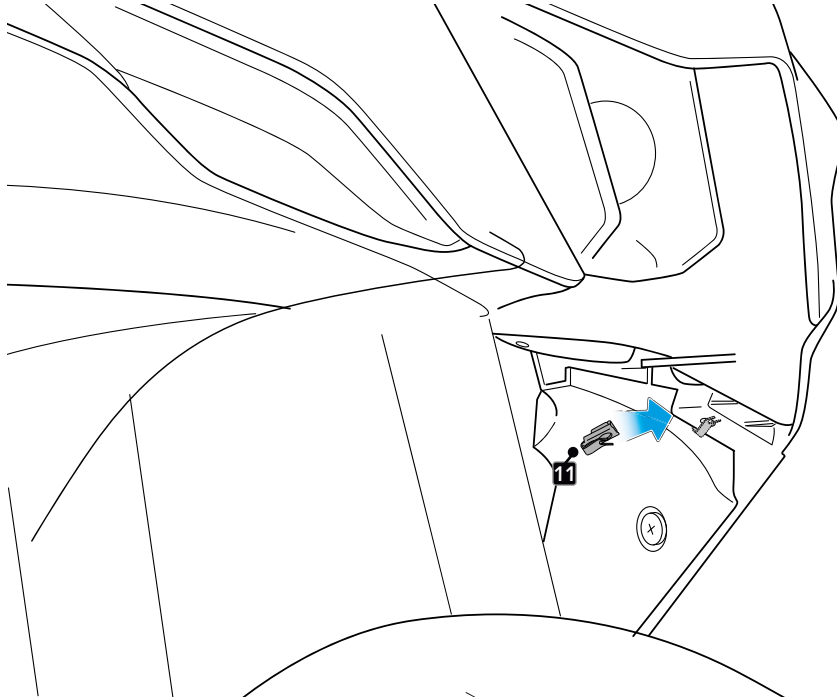

4

**ASSEMBLY
MONTAJE**

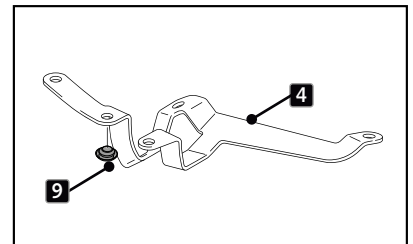
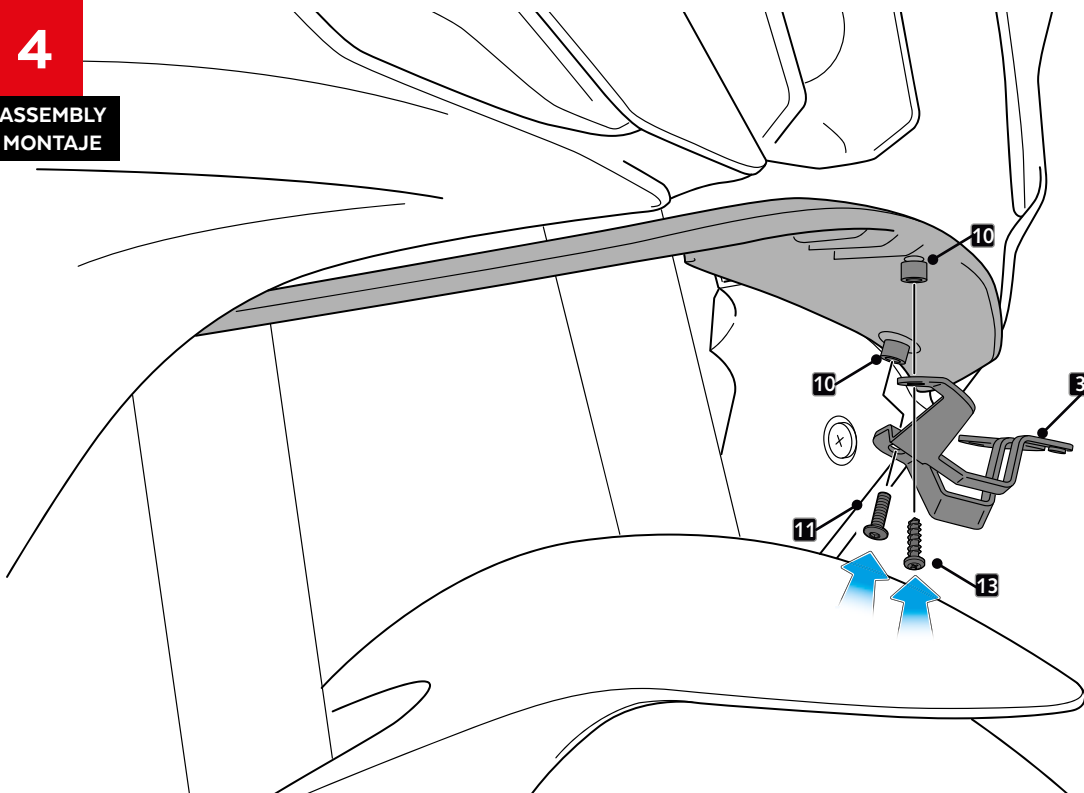

YAMAHA YZF-R7 '22-

INSTRUCCIONES DE MONTAJE - MOUNTING INSTRUCTIONS - MONTAGEANLEITUNG

5

ASSEMBLY
MONTAJE



PRESS HARD THE PEN ID14
UNTIL THE GLASS INSIDE
BREAKS AND
THE FLUID FLOWS



APPLY THE PEN
ONLY ON SPOILER
SUPPORT PIECE
AREA.



CHECK IS COMPLETELY DRY
BEFORE START.

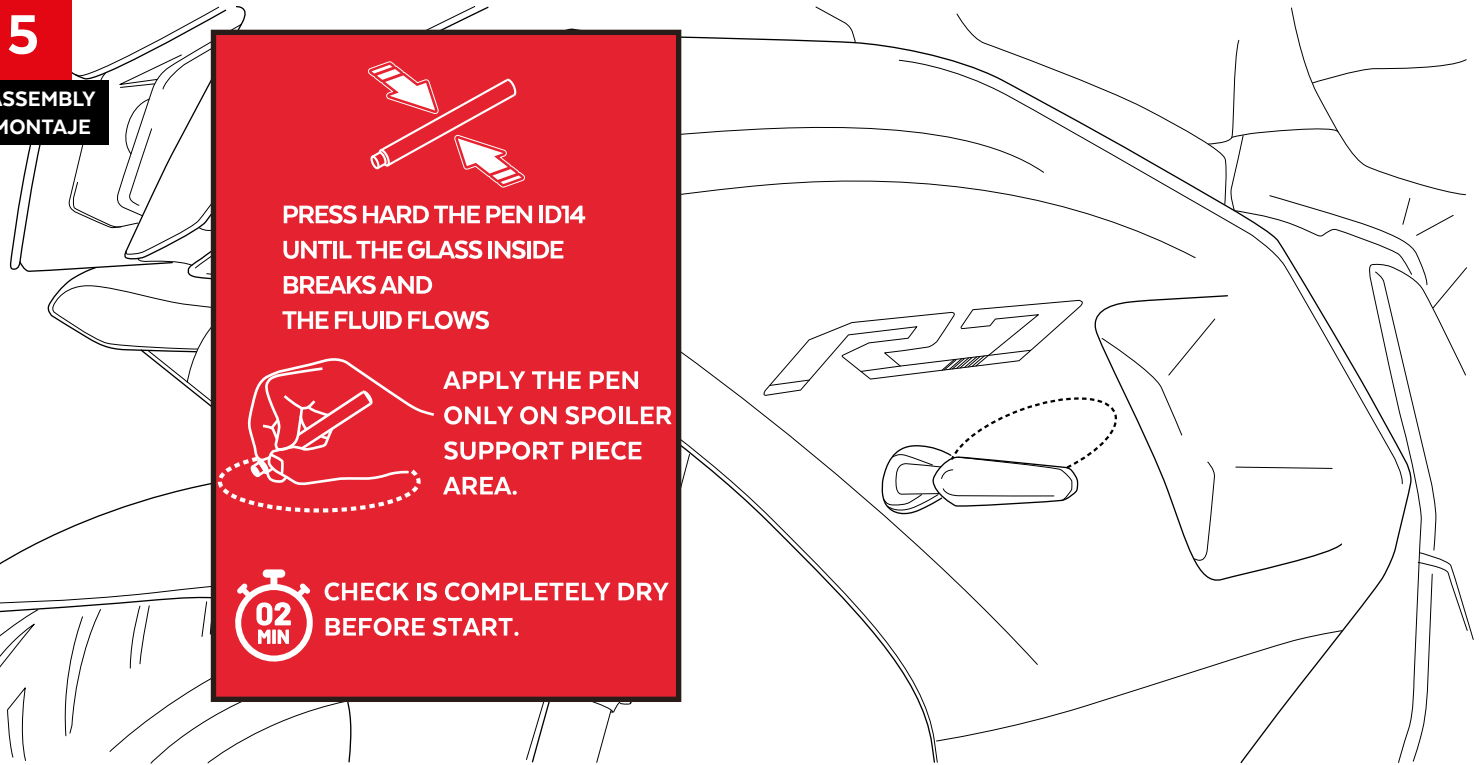

6

ASSEMBLY
MONTAJE

STEP 1.
PRE-ASSEMBLY

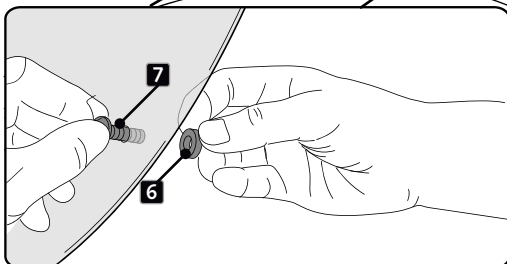
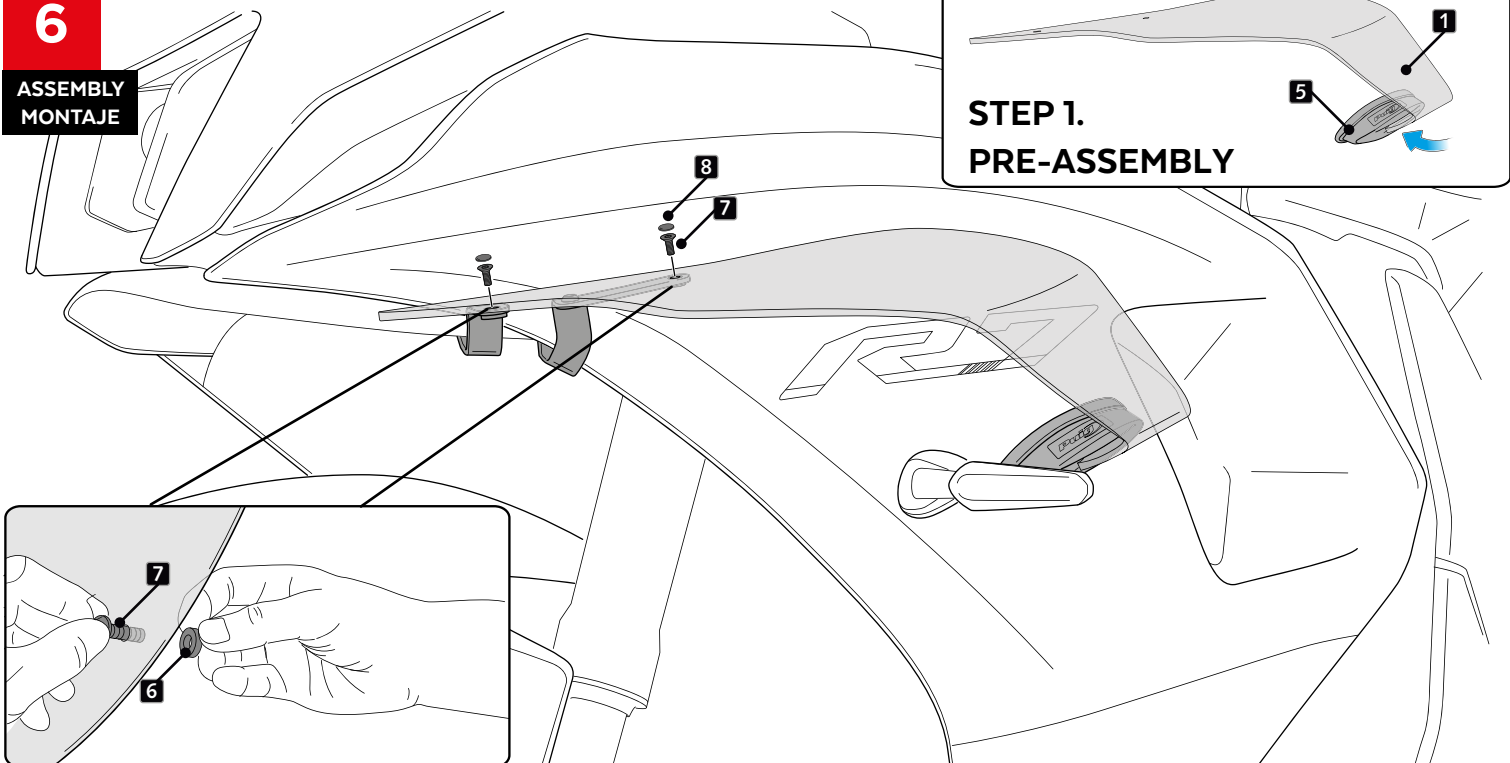
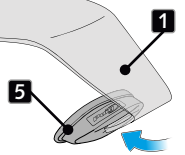

YAMAHA YZF-R7 '22-

INSTRUCCIONES DE MONTAJE - MOUNTING INSTRUCTIONS - MONTAGEANLEITUNG

7

ASSEMBLY
MONTAJE

7.1 DOBLAR LOS EXTREMOS DE LA PIEZA
FOLD THE ENDS OF THE PIECE

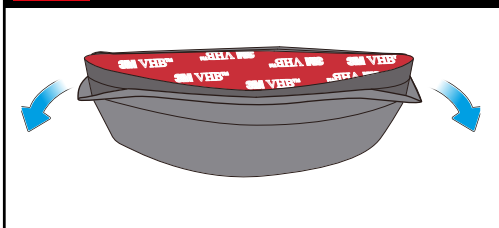

7.2 EXTRAER EL PAPEL ADHESIVO 3M
REMOVE PAPER FROM 3M ADHESIVE

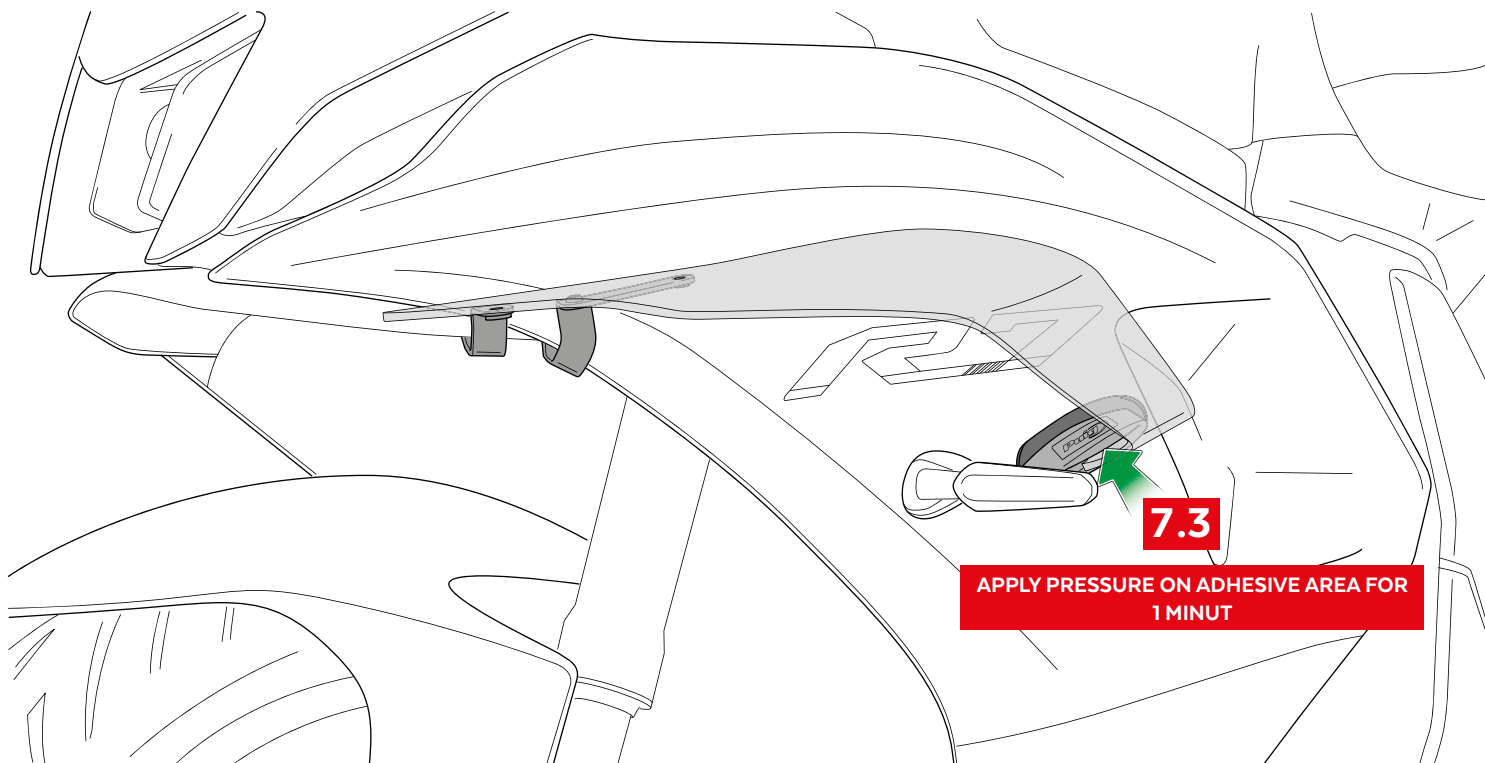

YAMAHA YZF-R7 '22-

INSTRUCCIONES DE MONTAJE - MOUNTING INSTRUCTIONS - MONTAGEANLEITUNG

8

ASSEMBLY
MONTAJE

WAIT 24 HOURS



CHECK THE CORRECT ADHESION
OF THE 3M DOUBLE SIDE
SELF-ADHESIVE TAPE
TO THE FAIRING. ENSURE THAT
THE ENTIRE SURFACE
IS WELL ADHERED





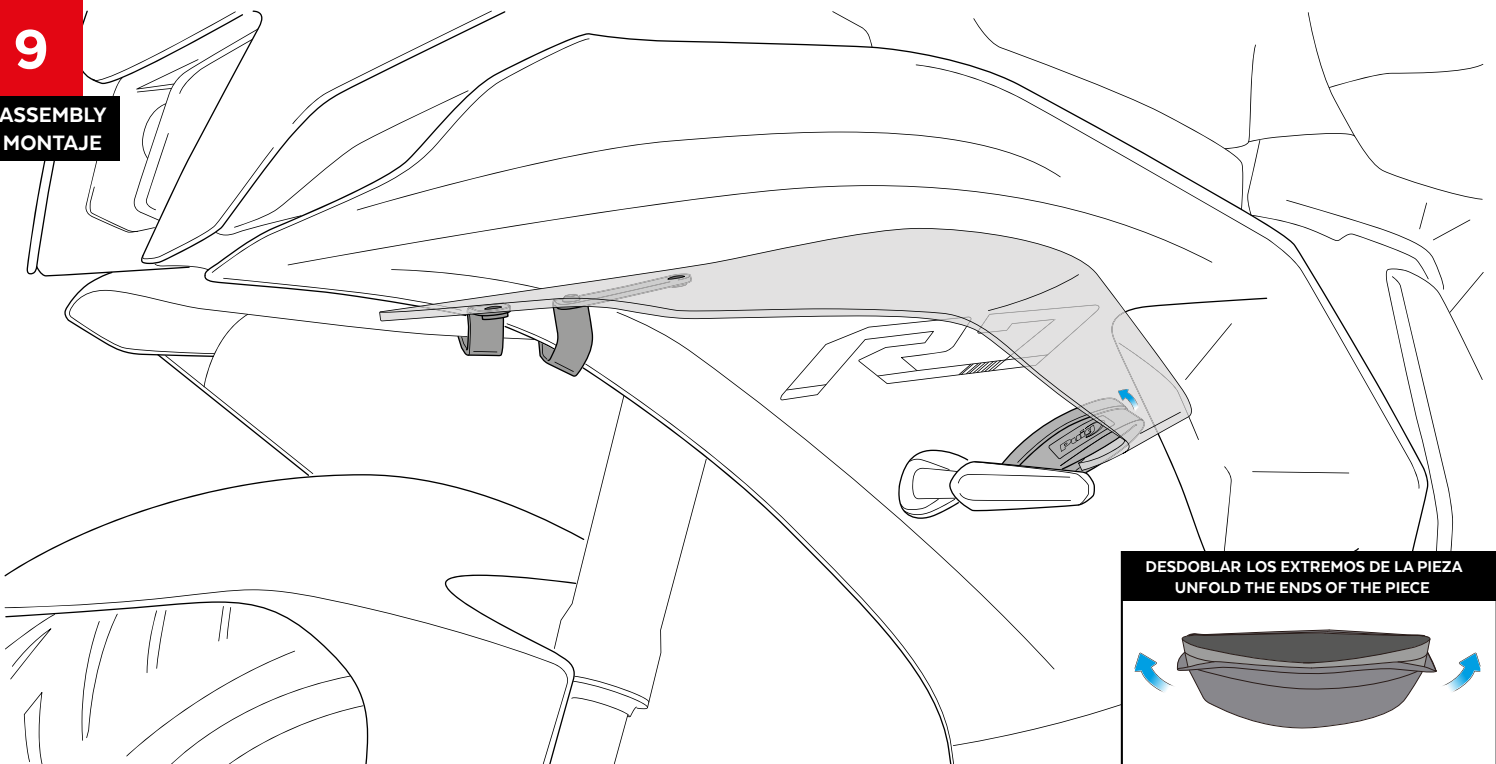



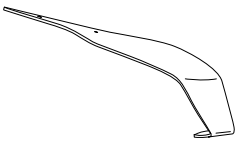
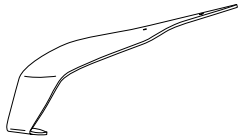
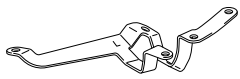
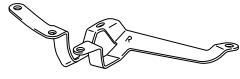

9

ASSEMBLY
MONTAJE



DESDOBLAR LOS EXTREMOS DE LA PIEZA
UNFOLD THE ENDS OF THE PIECE

YAMAHA YZF-R7 '22-

ID	PIEZA/PART	DESCRIPCIÓN	DESCRIPTION	QTY	REF
1		Alerón izquierdo	Left spoiler	1	21223N/H/J /C/AM3
2		Alerón derecho	Right spoiler	1	21223N/H/J /C/AM3
3		Soporte izquierdo (L)	Left support (L)	1	SOPOR2P5-L21223
4		Soporte derecho (R)	Right support (R)	1	SOPOR2P5-R21223
5		Pieza soporte alerón (tamaño pequeño)	Spoiler support piece	2	SOPOR-I---20431
6		Arandela de goma Ø4,5 x Ø11 x 2mm	Ø4,5 x Ø11 x 2mm ruber washer	4	ARAND-EPDM--722
7		Tornillo M5x12 DIN7991	M5x12 DIN7991 Screw	4	TORNI-D7991-611
8		Tapón tornillo M5 DIN7991	M5 DIN7991 Screw cap	4	TAPON-----92
9		Tope de goma Ø10,5 x Ø7,9 mm	Ø10,5 x Ø7,9 mm Bumper foot	2	TAPON-----95
10		Casquillo Ø8 x Ø14 x 7,5 mm	Ø8 x Ø14 x 7,5 mm arrowhead	4	CASQUI8147-0193
11		Tornillo Allen M6x25 Ø11 ISO 7380	M6x25 Ø11 ISO 7380 Allen screw	2	TORNI-I7380-626
12		Tuerca de clip M6	M6 nut	2	TUERCAJM6---912
13		Tornillo roscachapa Ø5x25 DIN7505B	Ø5x25 DIN7505B screw	2	TORNI-D7505-754
14		Lápiz AP111 Adhesion promoter	AP111 adhesion promoter Pen	1	KITNETEJA3M----