

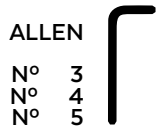

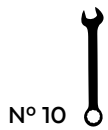



# HONDA CB750 HORNET '23-

## M O U N T I N G I N S T R U C T I O N S

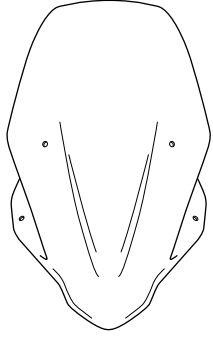
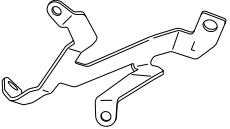
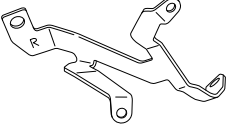
REF 21480

WINDSHIELD NG TOURING



ID	PIEZA/PART	DESCRIPCIÓN	DESCRIPTION	QTY	REF
1		Cúpula Touring	Touring screen	1	21480H/W/F/NM
2		Soporte Izquierdo ( L )	Left support ( L )	1	SOPOR2P5-L21479
3		Soporte derecho ( R )	Right support ( R )	1	SOPOR2P5-R21479
4		Tornillo M6x16 Ø14 ISO 7380	M6x16 Ø14 ISO 7380 Allen screw	2	TORNI-I7380-403
5		Silentblock Ø12xØ6x9	Ø12xØ6x9 Silentblock	4	AROPASACABLES-1
6		Casquillo con valona Ø12xØ6,8x7,3	Ø12xØ6,8x7,3 bush with flange	4	CASQUI-1A---750
7		Tornillo Allen M5x12 Ø11 ISO 7380	M5x12 Ø11 ISO 7380 Allen screw	4	TORNI-AI----520
8		Tapón tornillo M5 ISO 7380	M5 ISO 7380 screw cap	4	TAPON-----85

# HONDA CB750 HORNET '23-

INSTRUCCIONES DE MONTAJE - MOUNTING INSTRUCTIONS - MONTAGEANLEITUNG

**1**

**DISASSEMBLY  
DESMONTAJE**

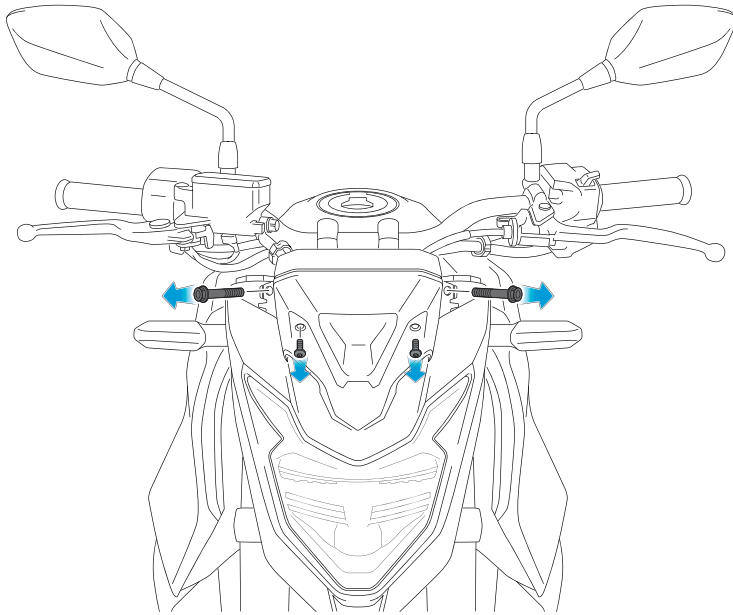

NO EXTRAER TODOS LOS TORNILLOS A LA VEZ.  
REALIZAR EL MONTAJE DE LOS SOPORTES UNO POR UNO.

DO NOT REMOVE ALL THE SCREWS AT THE SAME TIME.  
MOUNT THE SUPPORTS ONE BY ONE.

**2**

**ASSEMBLY  
MONTAJE**

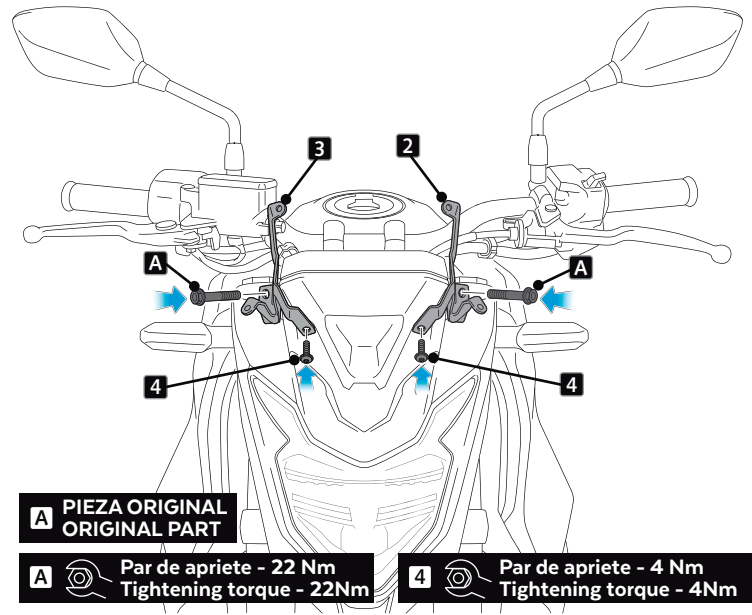

**A** PIEZA ORIGINAL  
ORIGINAL PART

**A** Par de apriete - 22 Nm  
Tightening torque - 22Nm

**4** Par de apriete - 4 Nm  
Tightening torque - 4Nm

**3**

**ASSEMBLY  
MONTAJE**

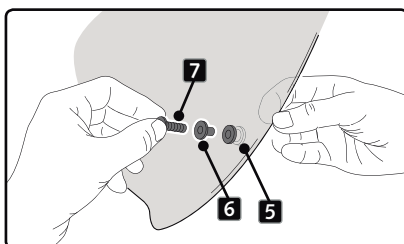
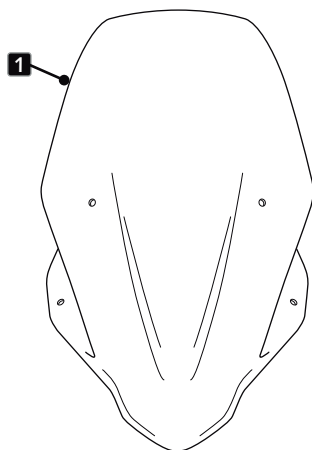

**4**

**ASSEMBLY  
MONTAJE**

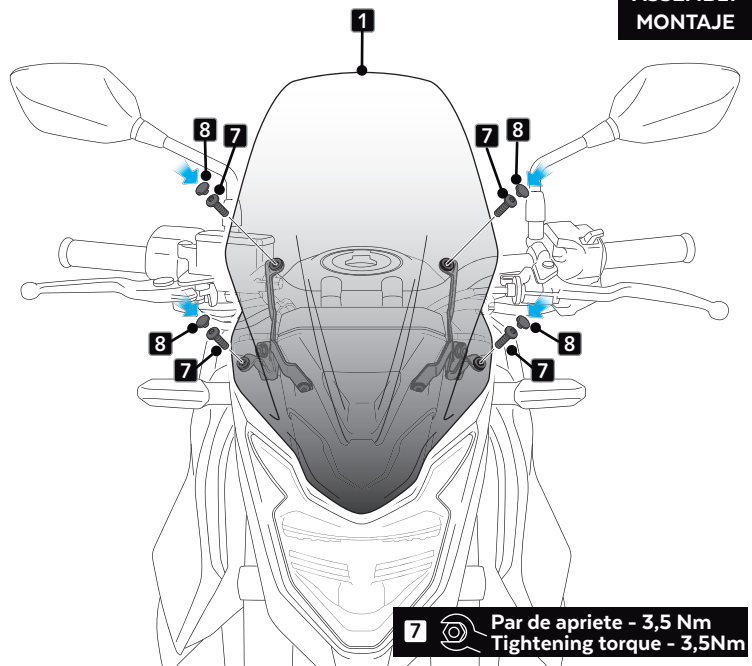

**7** Par de apriete - 3,5 Nm  
Tightening torque - 3,5Nm