

HONDA REBEL CMX 500-300 '17-

M O U N T I N G I N S T R U C T I O N S

REF 3701

ALUMINIUM FRONT PLATE

REF 3702

ABS FRONT PLATE



1 Person



15 min









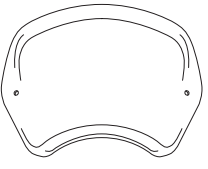
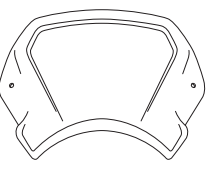
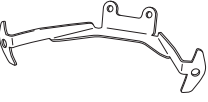

EASY



ALLEN
Nº 3
Nº 5



ID	PIEZA/PART	DESCRIPCIÓN	DESCRIPTION	QTY	REF
1		Placa frontal ABS	ABS front plate	1	10526J/C
		Placa frontal Aluminio	Aluminium front plate		9807P/N
2		Soporte metálico	Metal support (R1)	1	SOP1P5-----3701
3		Silentblock M5	M5 silentblock	2	SILENBTM5-046/1
4		Arandela de nylon M5x1	M5x1 nylon washer	2	ARNV0000000245
5		Tornillo Allen M5x16 ISO7380 (INOX)	M5x16 ISO7380 Allen screw (INOX)	2	TORNIAI7380-314
6		Tapón tornillo M5	M5 screw cap	2	TAPON-----85
7		Separador de silicona Ø8 x2 (se suministra montado con pieza 2)	Ø8 x2 silicon spacers (supplied already mounted on items 2)	4	ADHESI-GT-D8---
8		Ribete autoadhesivo (longitud de 190mm , 6,2X2,6mm)	Selft-autoadhesive trim (length 190mm ,6,2 x2,6mm)	1	PERFIL-PVC-1048
9		Kit adhesivos	Stickers set	1	10535
10		Tornillo Allen M5x16 ISO7380	M5x16 ISO7380 Allen screw	2	TORNI-I7380-493

HONDA REBEL CMX 500-300 '17-

INSTRUCCIONES DE MONTAJE - MOUNTING INSTRUCTIONS - MONTAGEANLEITUNG

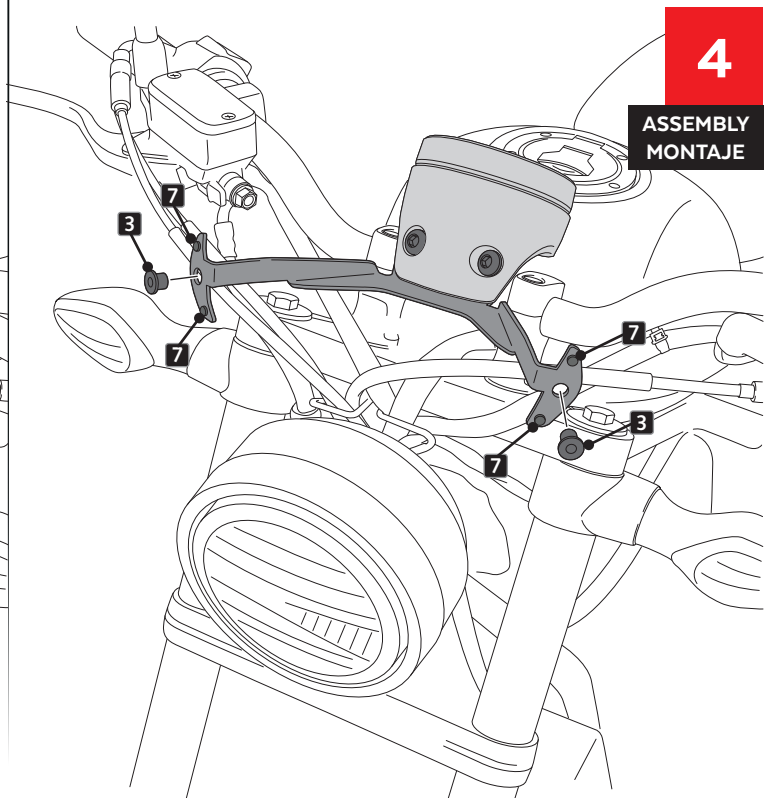
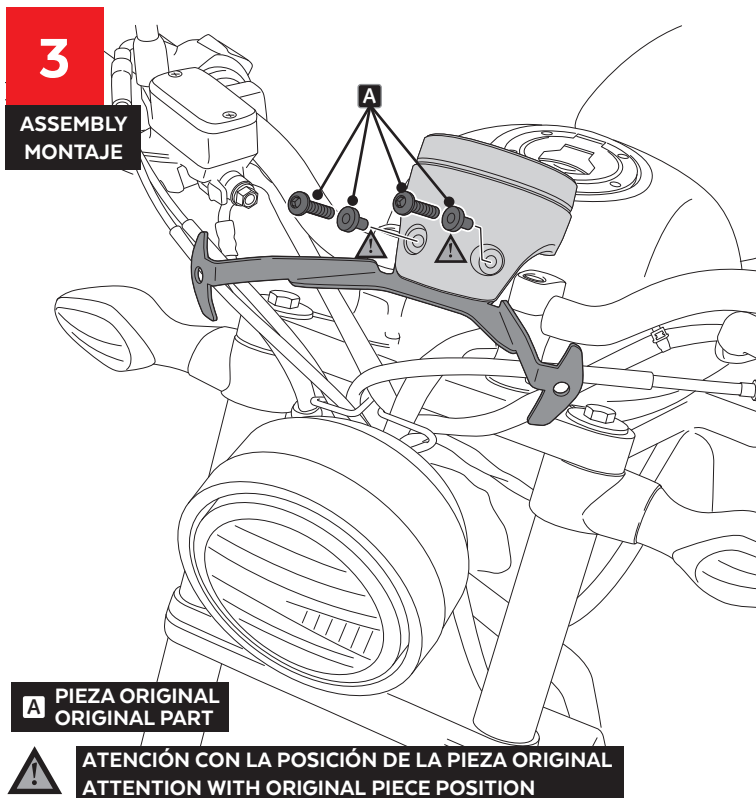
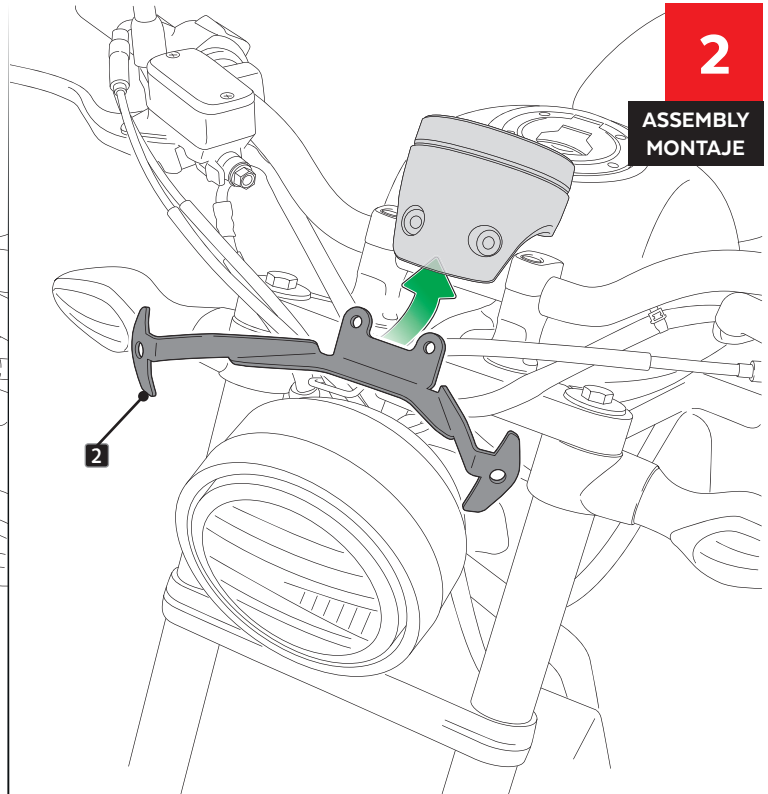
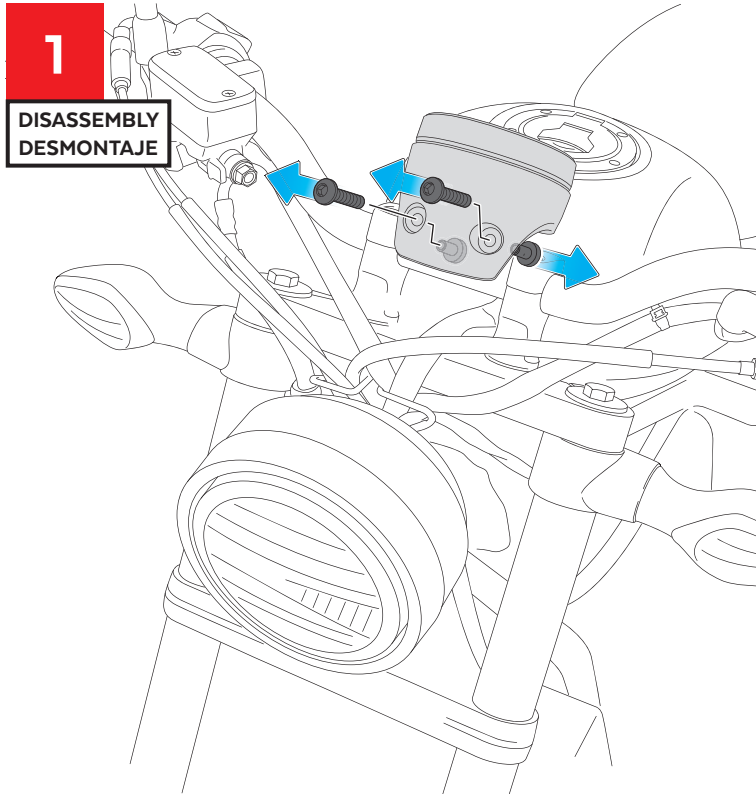

HONDA REBEL CMX 500-300 '17-

INSTRUCCIONES DE MONTAJE - MOUNTING INSTRUCTIONS - MONTAGEANLEITUNG

5

ASSEMBLY
MONTAJE

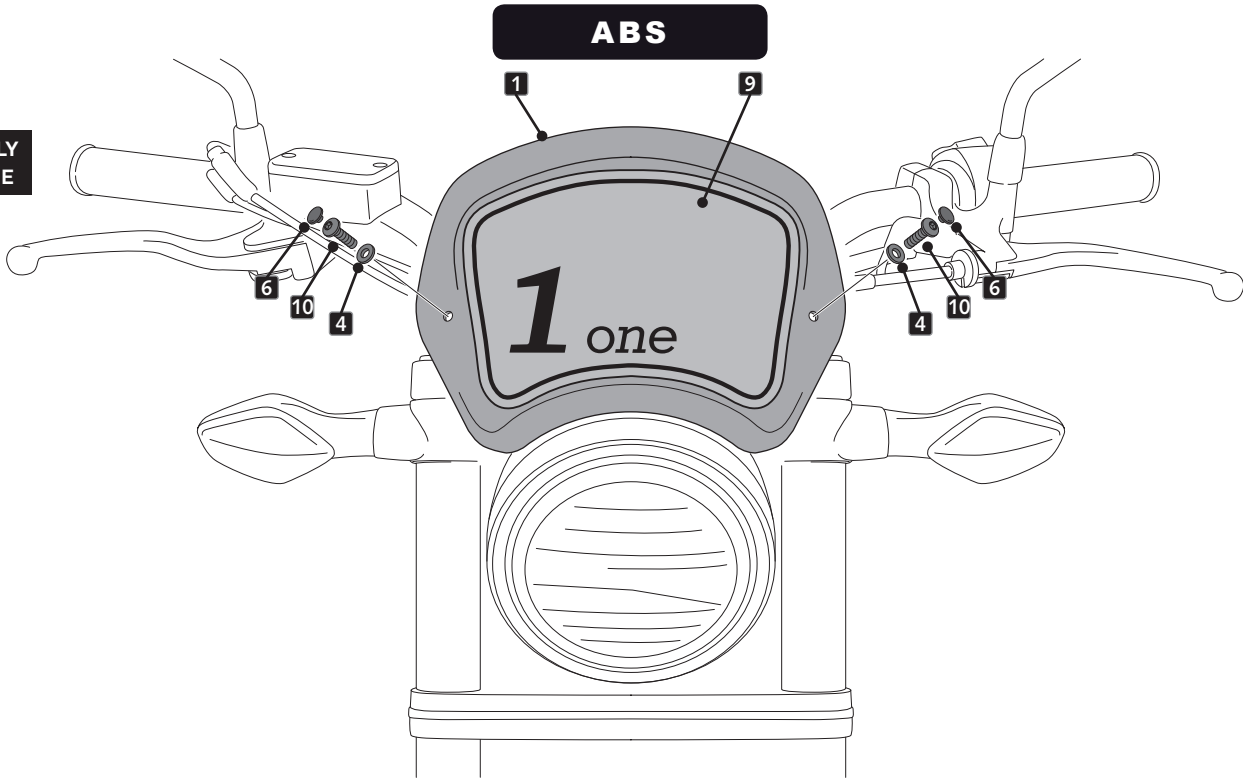

6

ASSEMBLY
MONTAJE

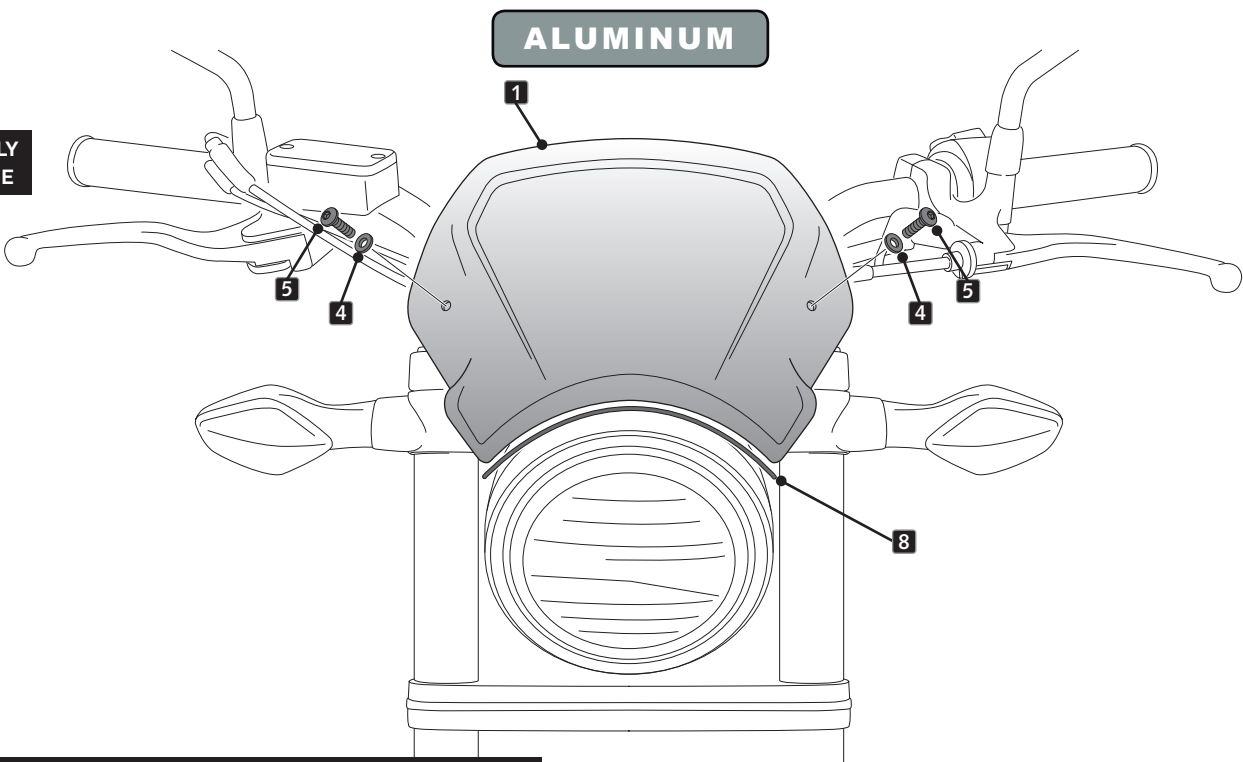

PONER RIBETE ANTES DE MONTAR LA PLACA FRONTAL.
PLACE TRIM BEFORE MOUNTING THE FRONT PLATE.