

EVOTECH®
P E R F O R M A N C E

www.evotech-performance.com

Suzuki GSX-S1000 Tail Tidy



Kit Contents PRN012754

- (A) 1 x Retro Light
- (B) 1 x Con 8
- (C) 2 x P-Clips (Number 3)
- (D) 2 x M4 x 6 Button Head Bolt
- (E) 2 x M4 Flange Nuts
- (F) 2 x M6 x 16mm Button head
- (G) 2 x M6 x 12 Button Head Bolt
- (H) 2 x Top Hat Spacer
- (J) 4 x Indicator Spacer
- (K) 4 x Rubber Washer
- (L) 5 x M5 x 12 Button Head Bolt

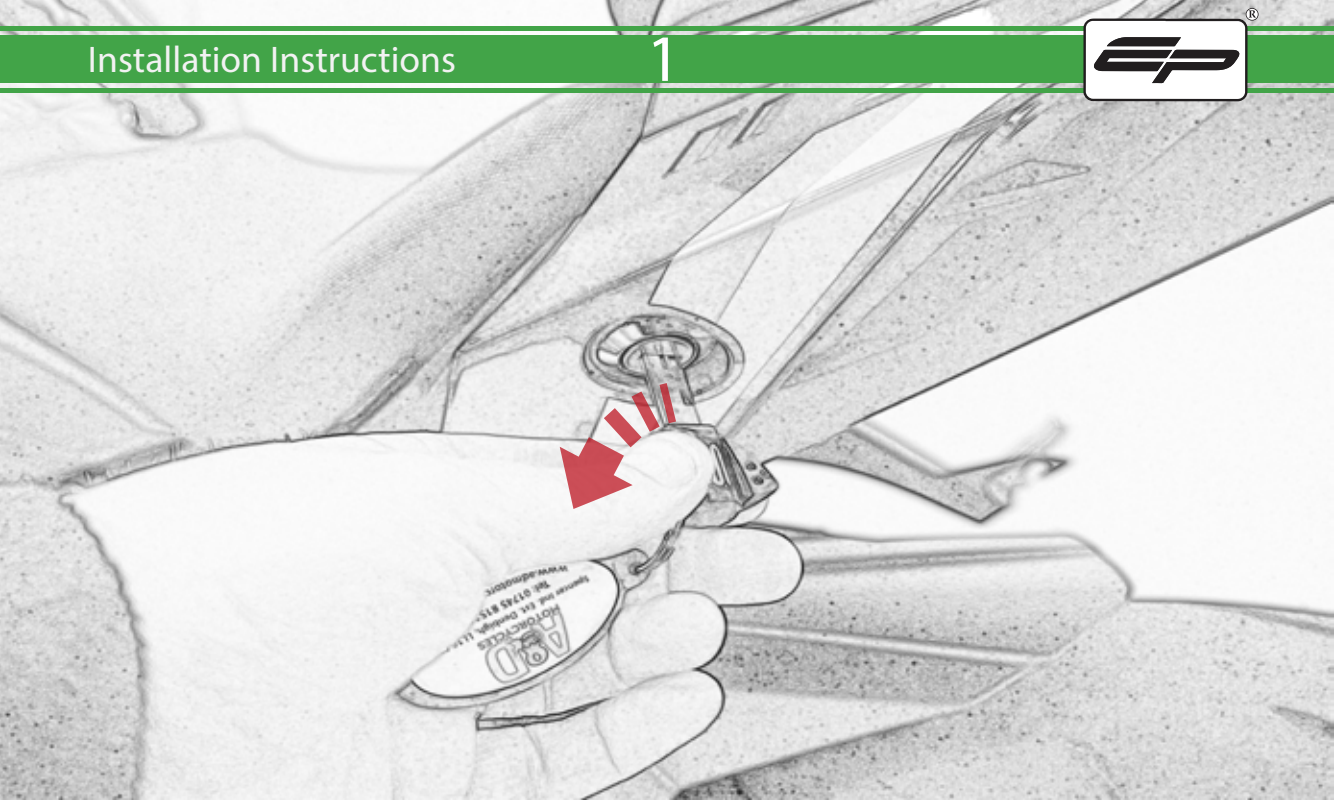

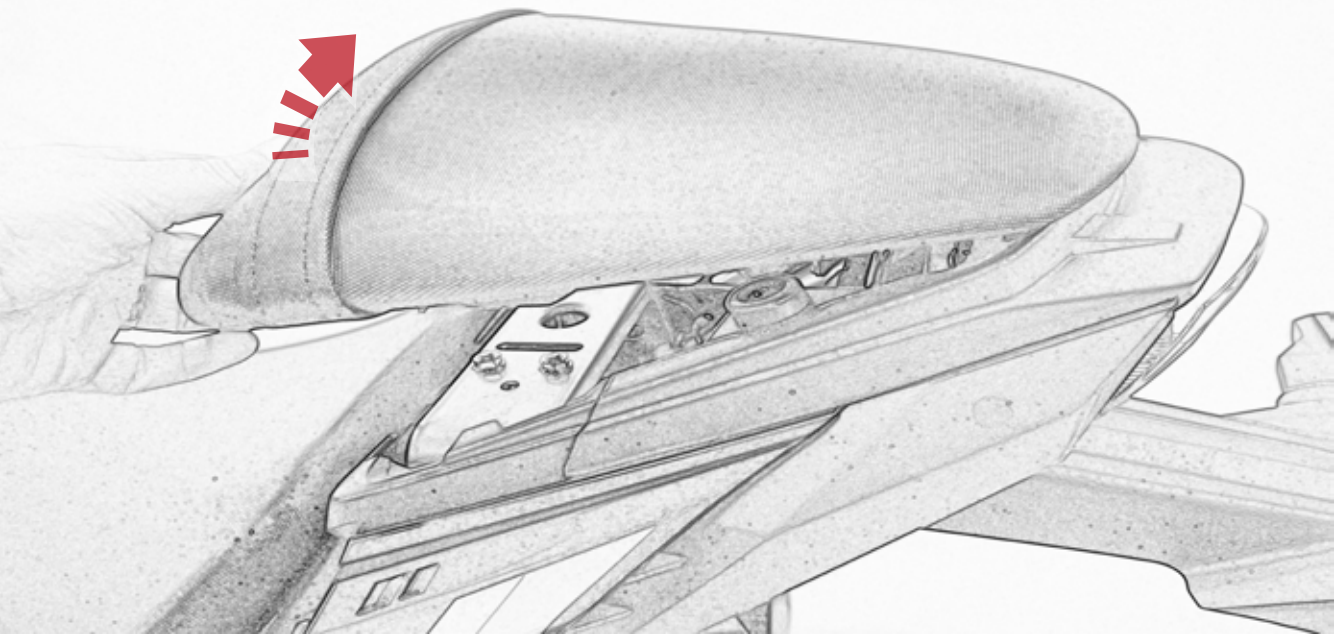

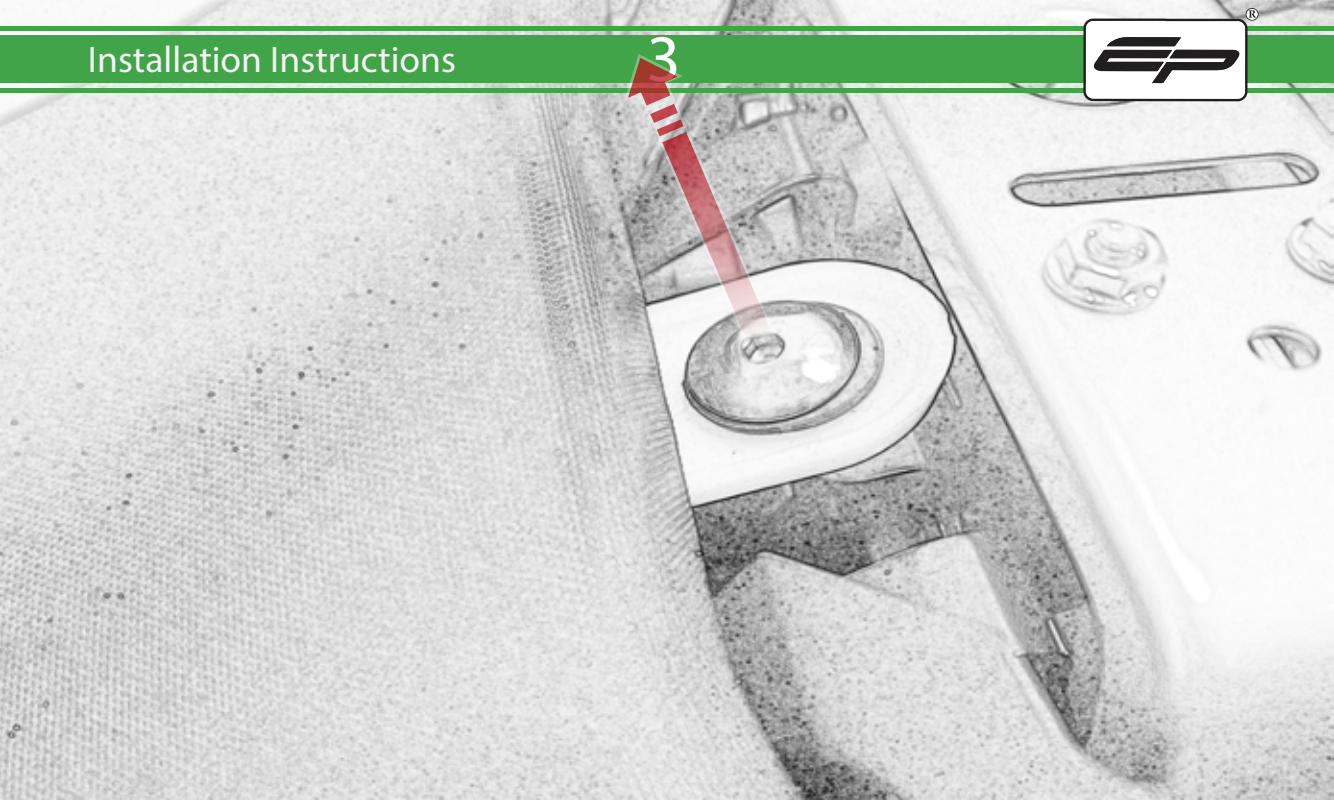



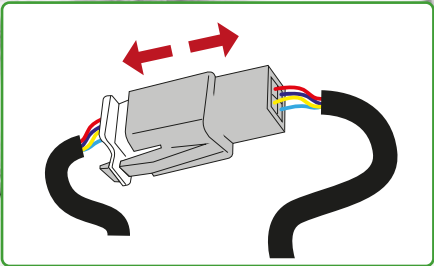
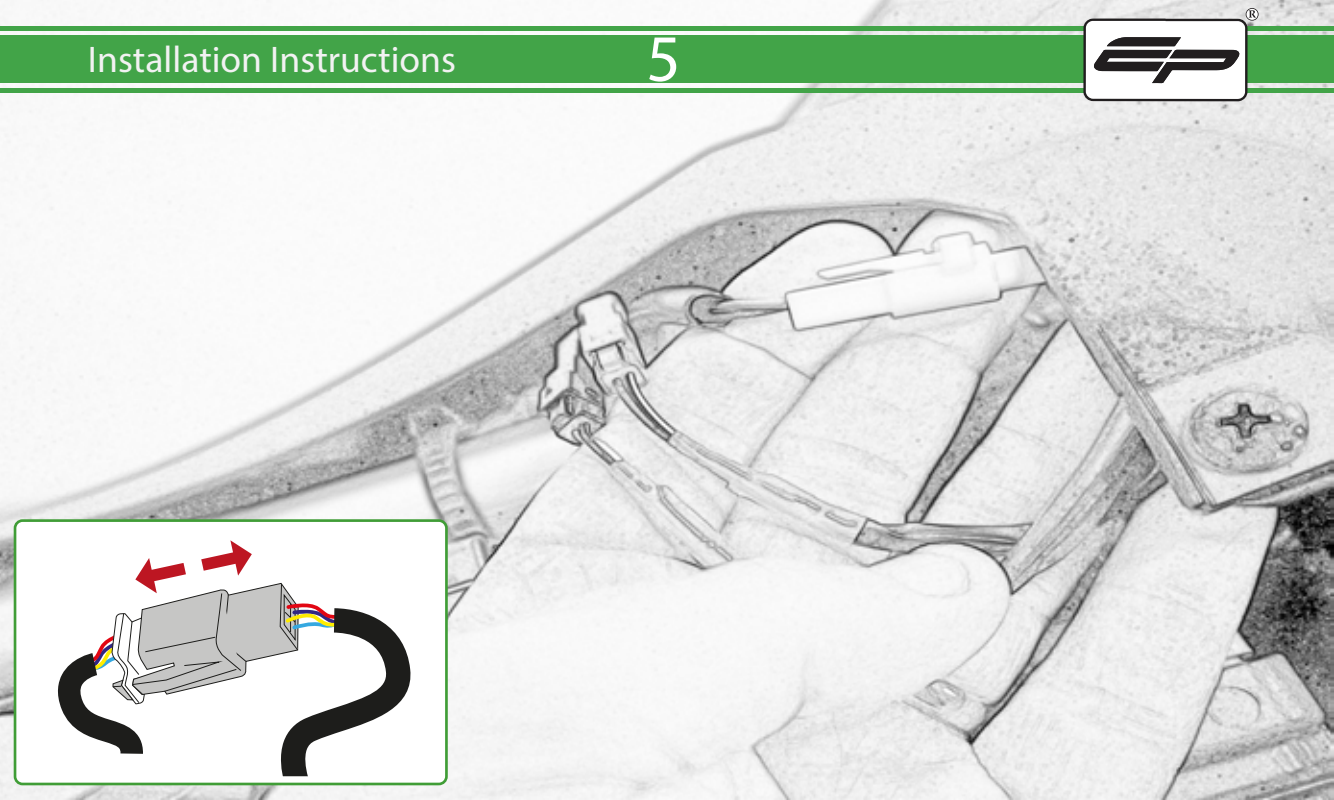

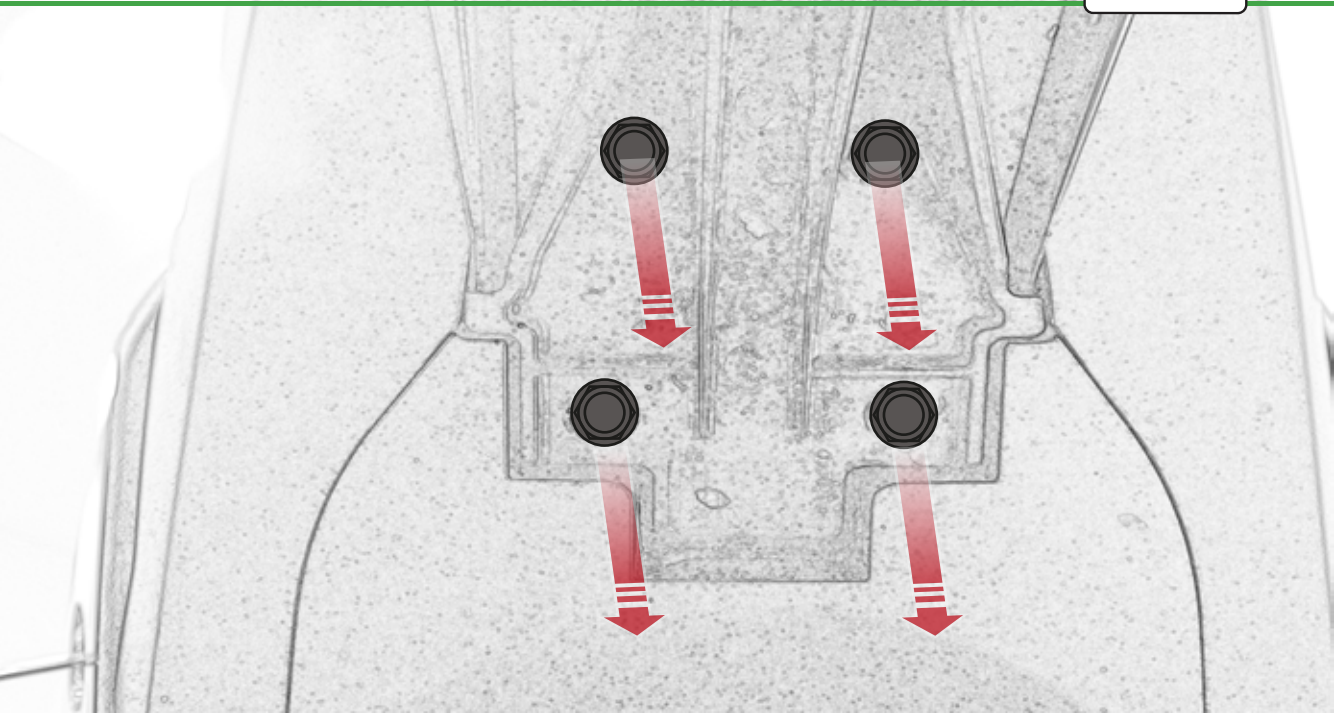

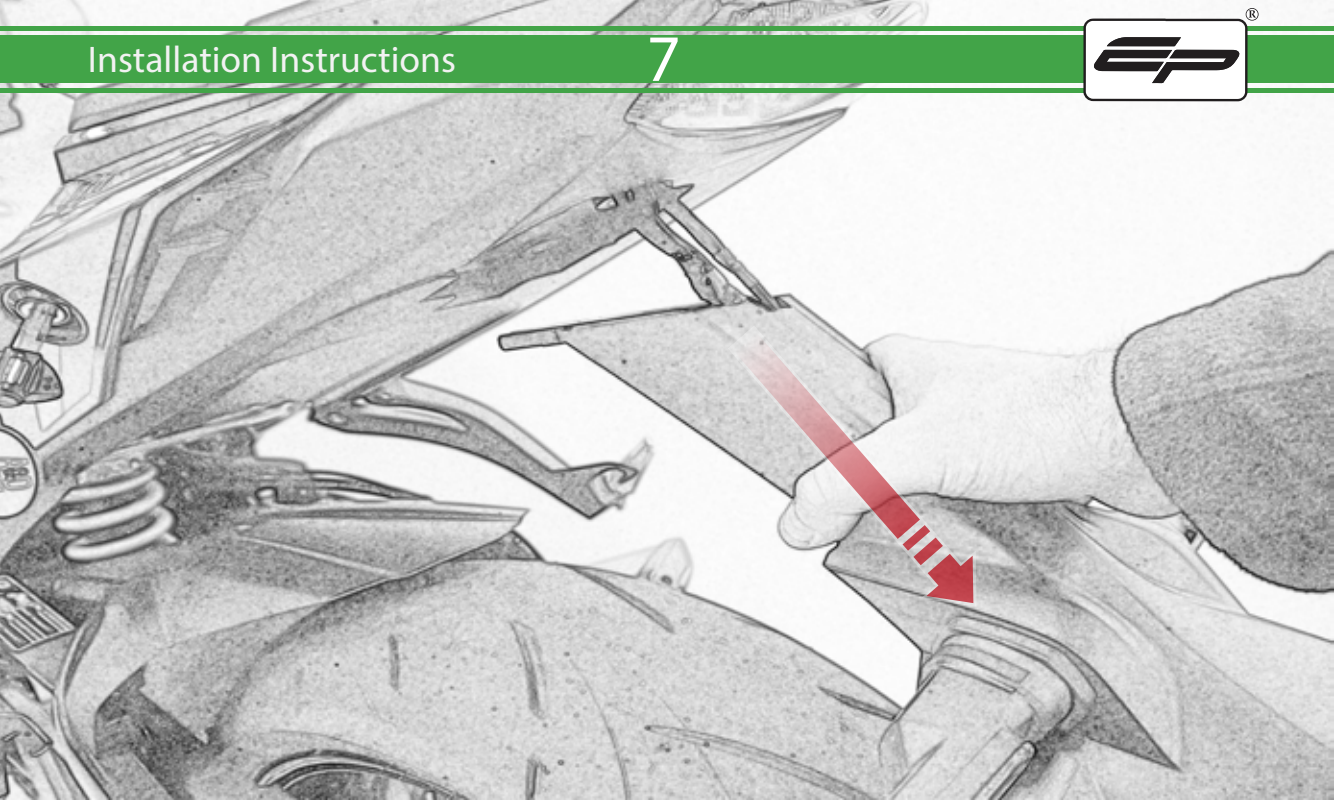

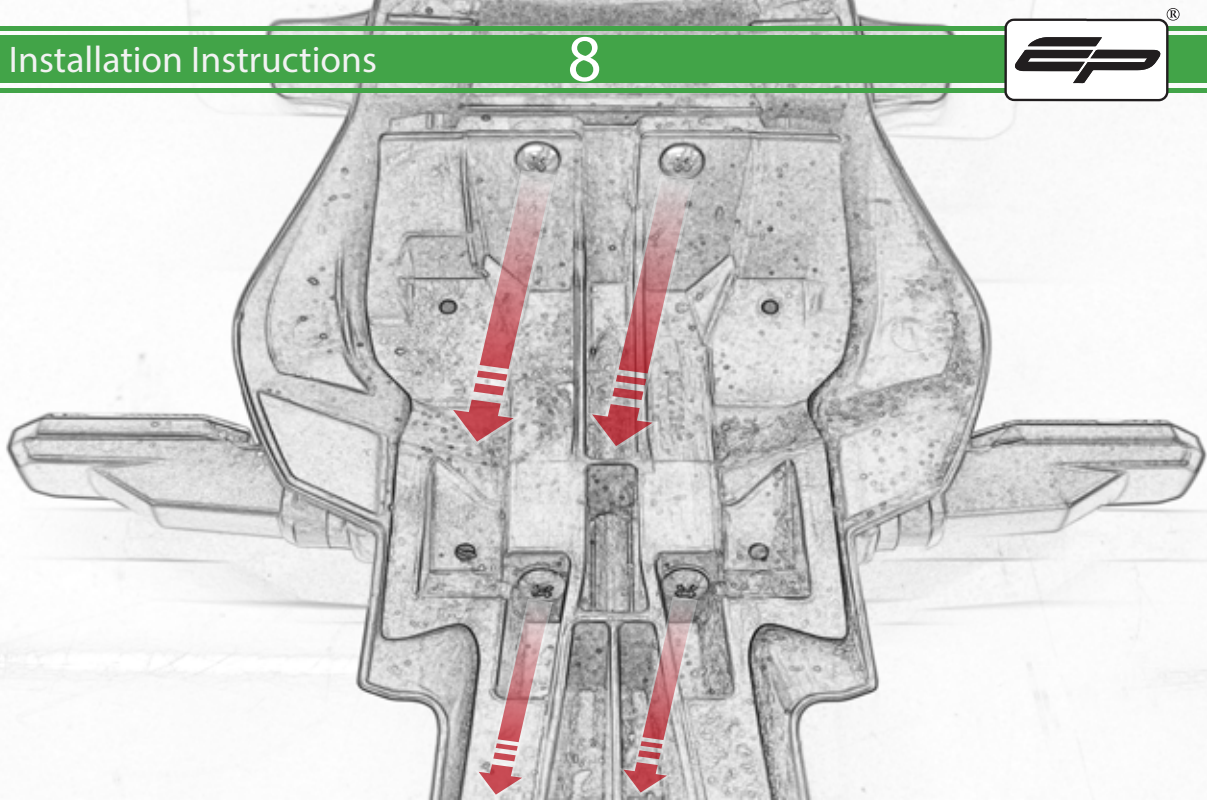

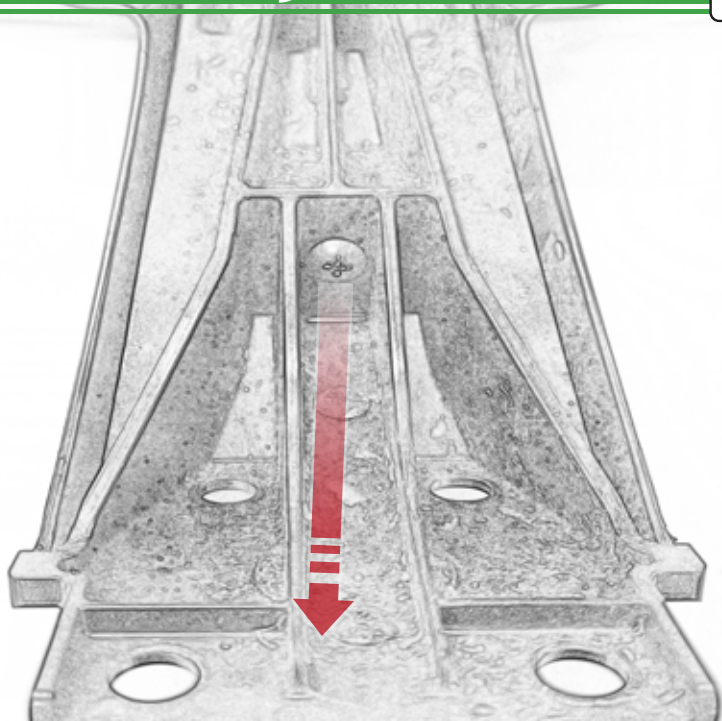

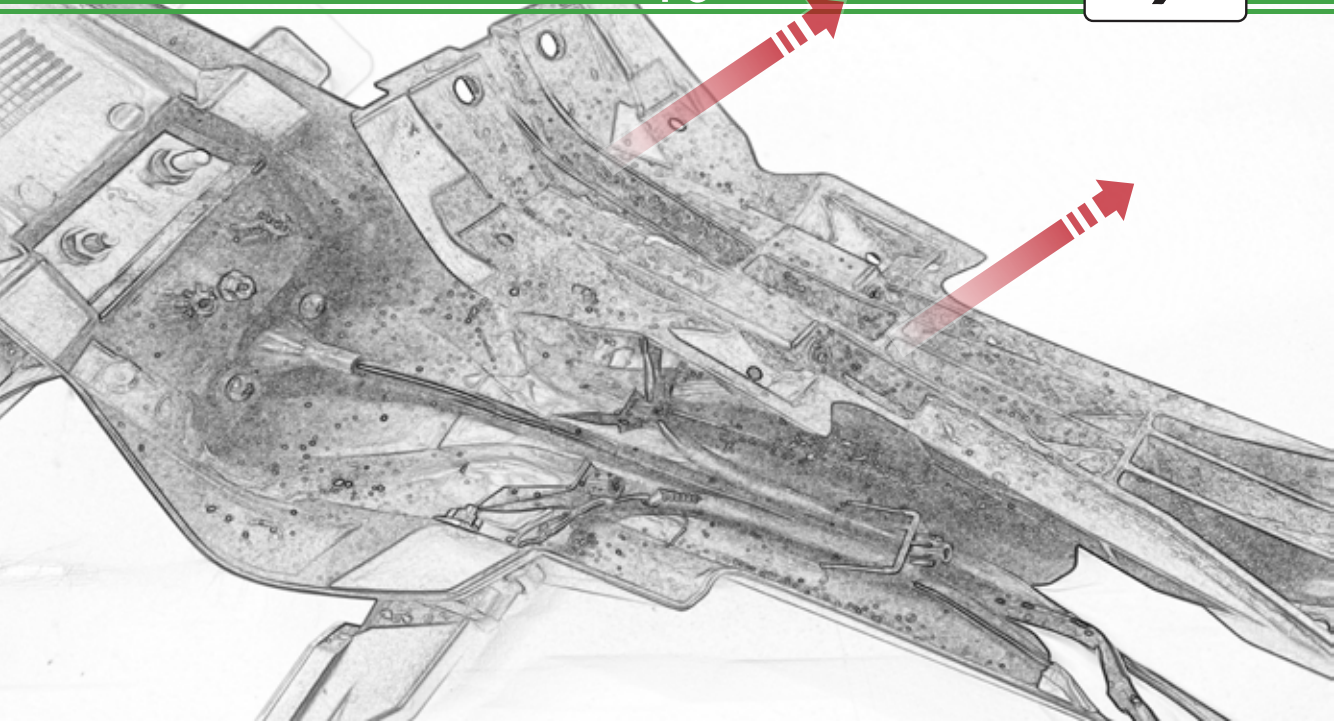

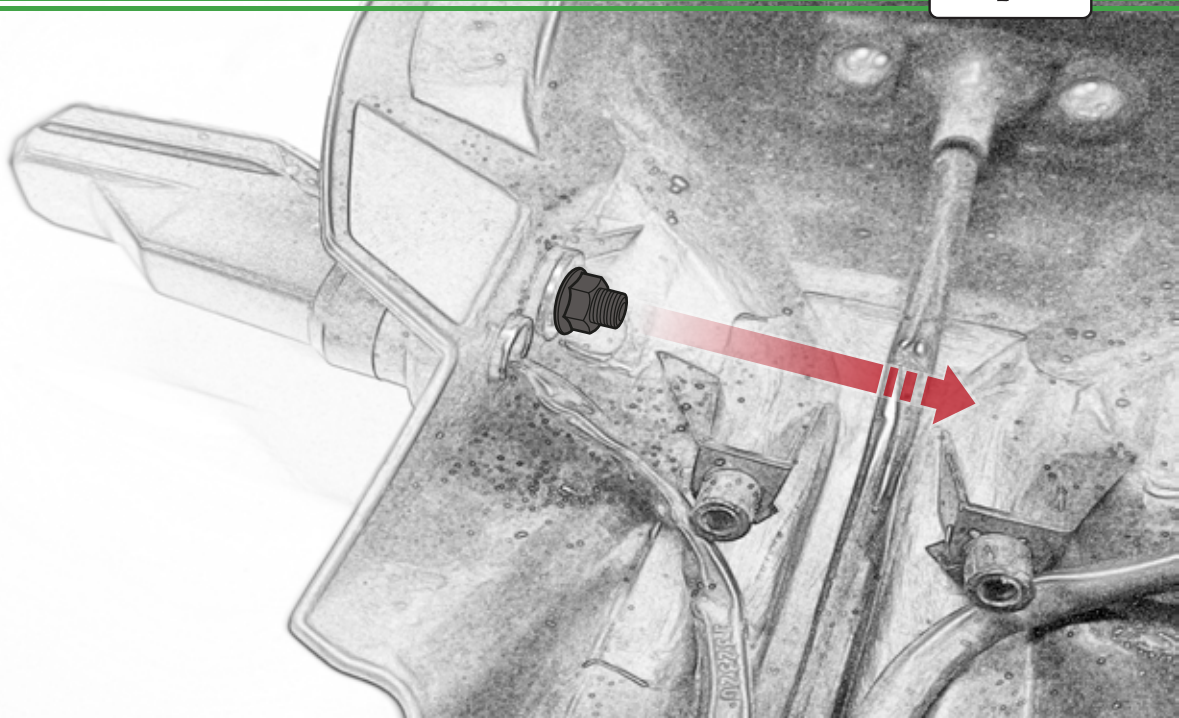

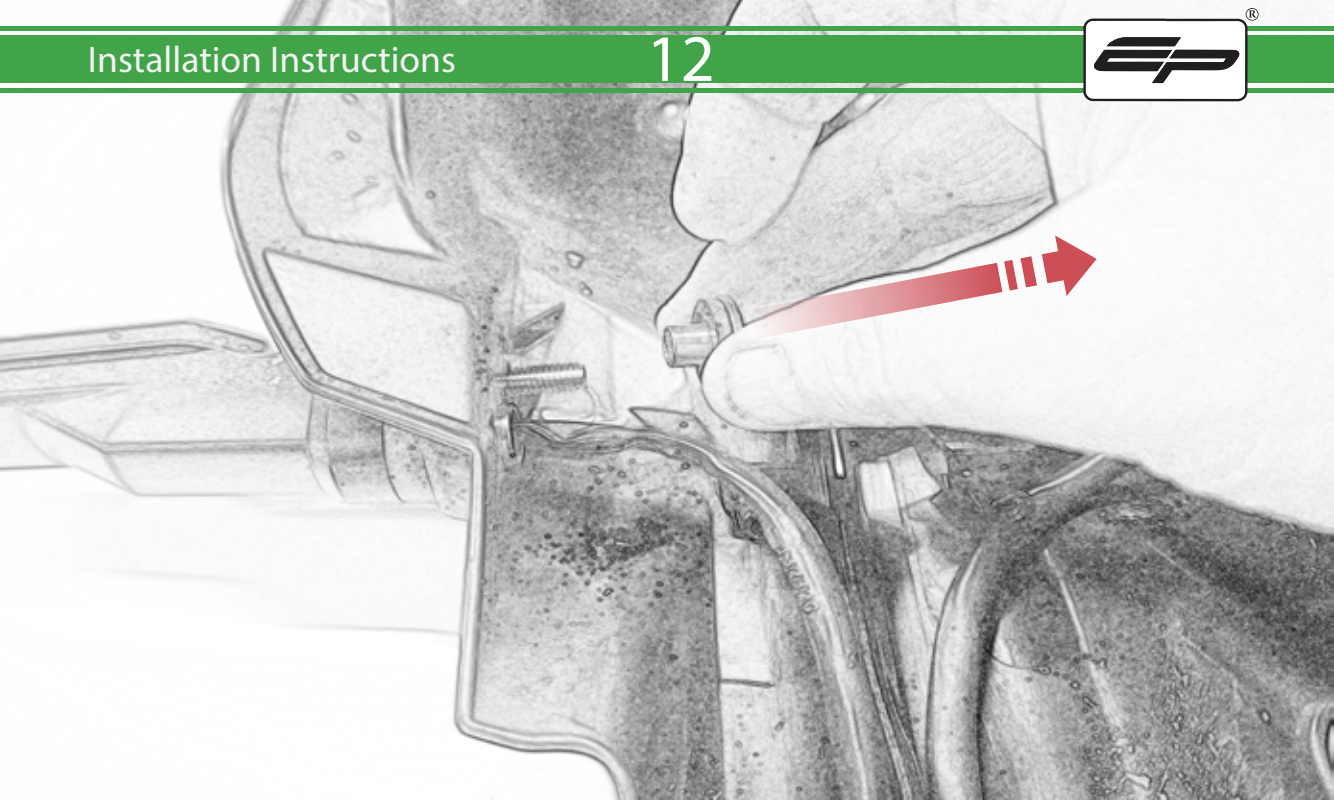

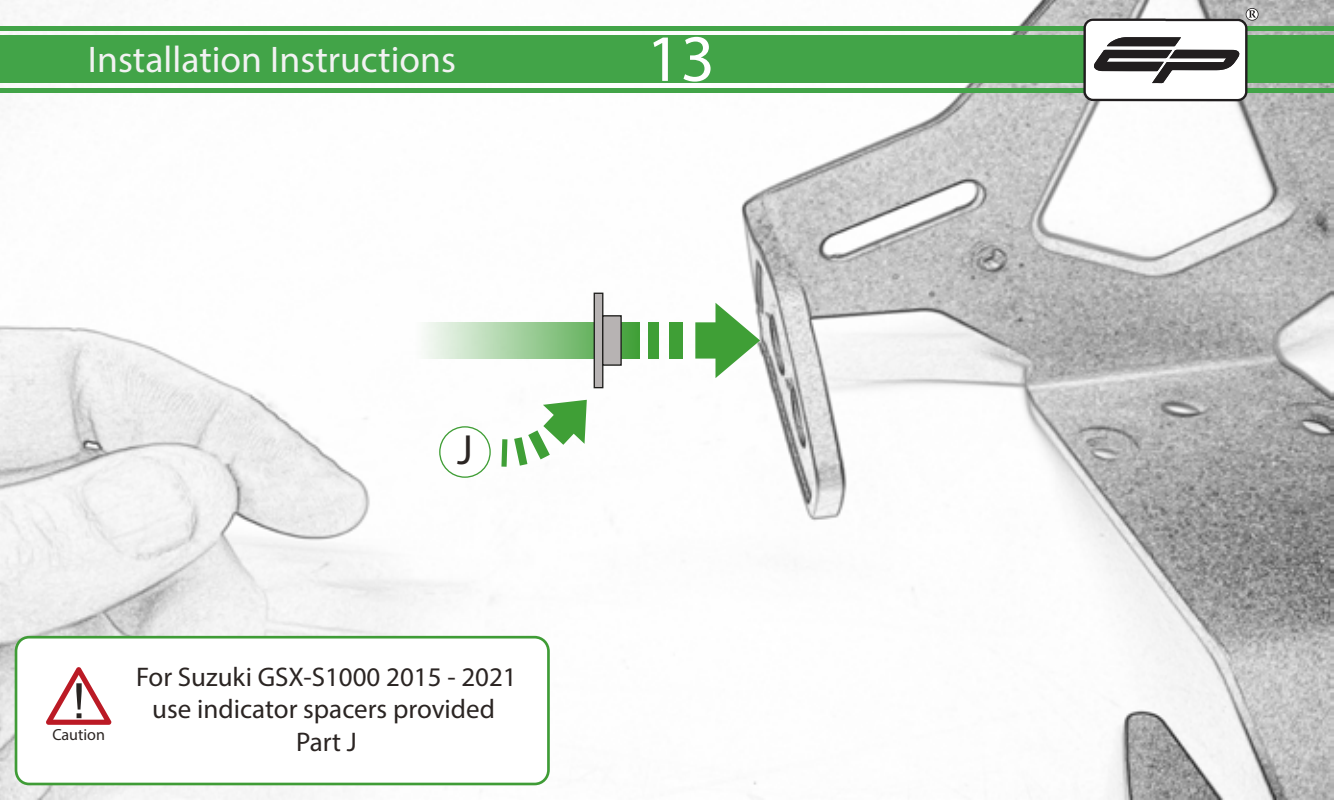

Caution

For Suzuki GSX-S1000 2015 - 2021
use indicator spacers provided
Part J

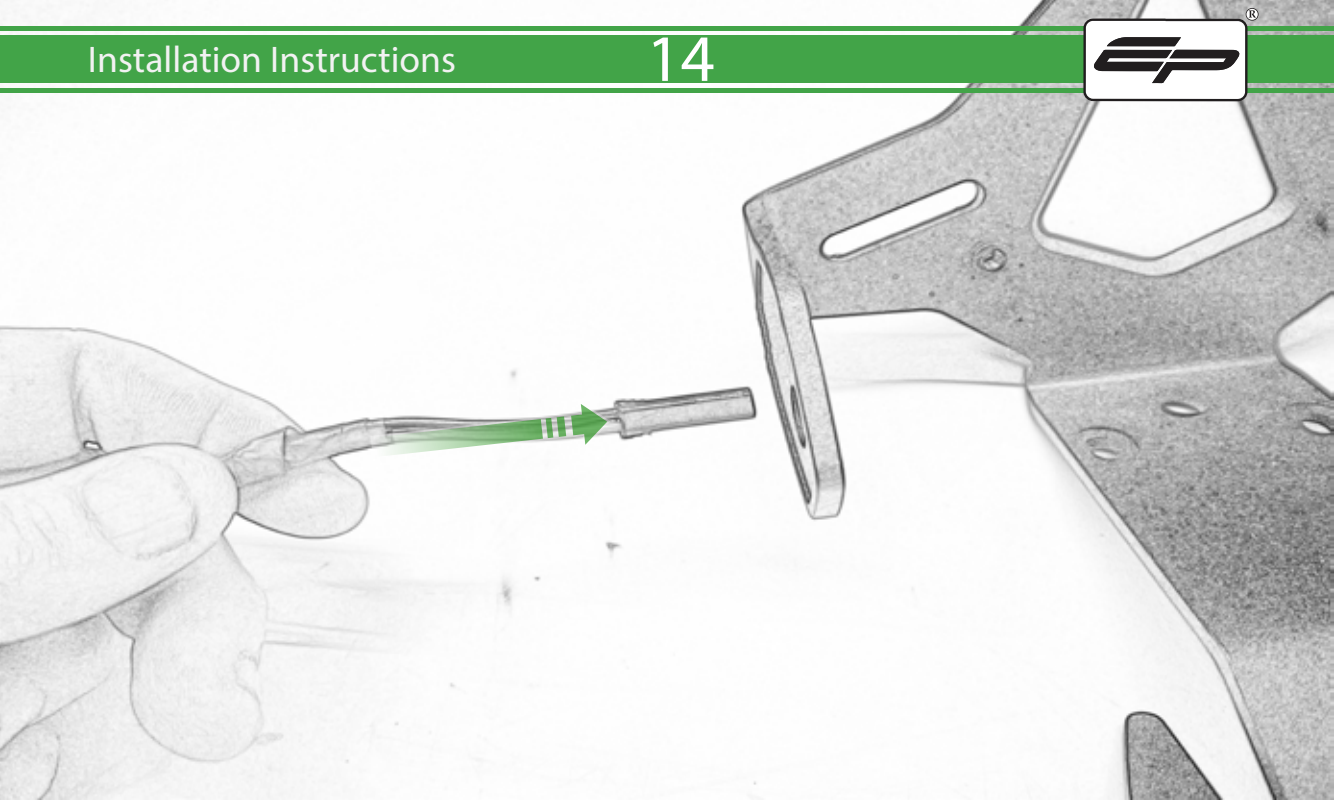

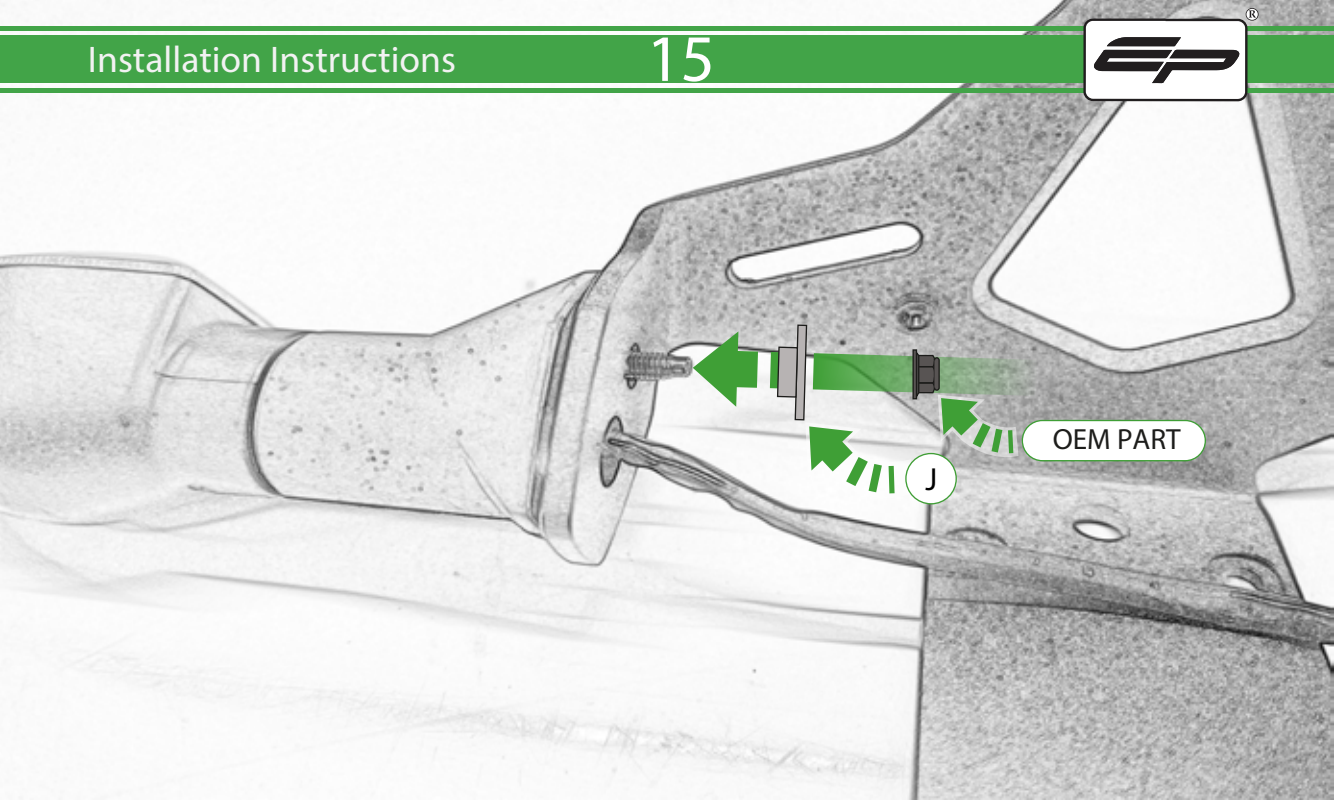

OEM PART

J

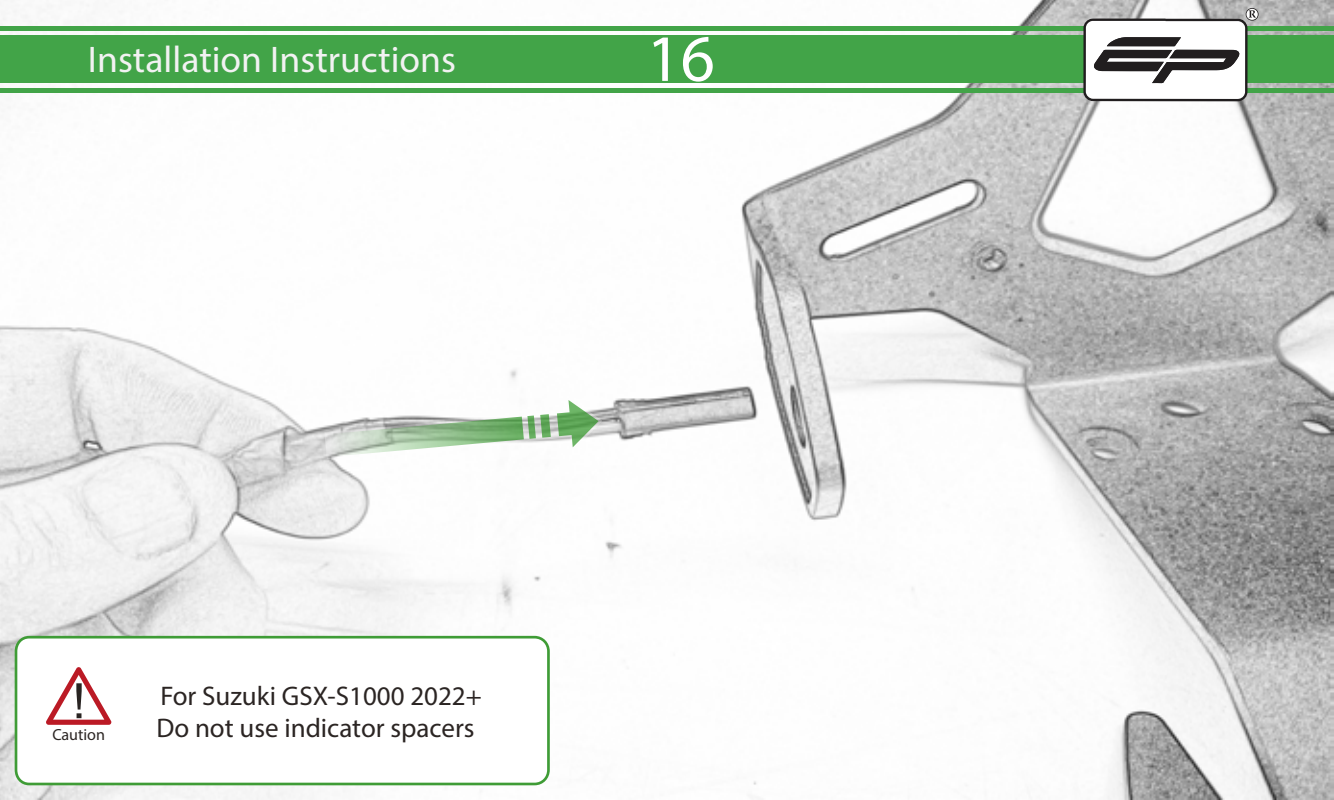

Caution

For Suzuki GSX-S1000 2022+
Do not use indicator spacers

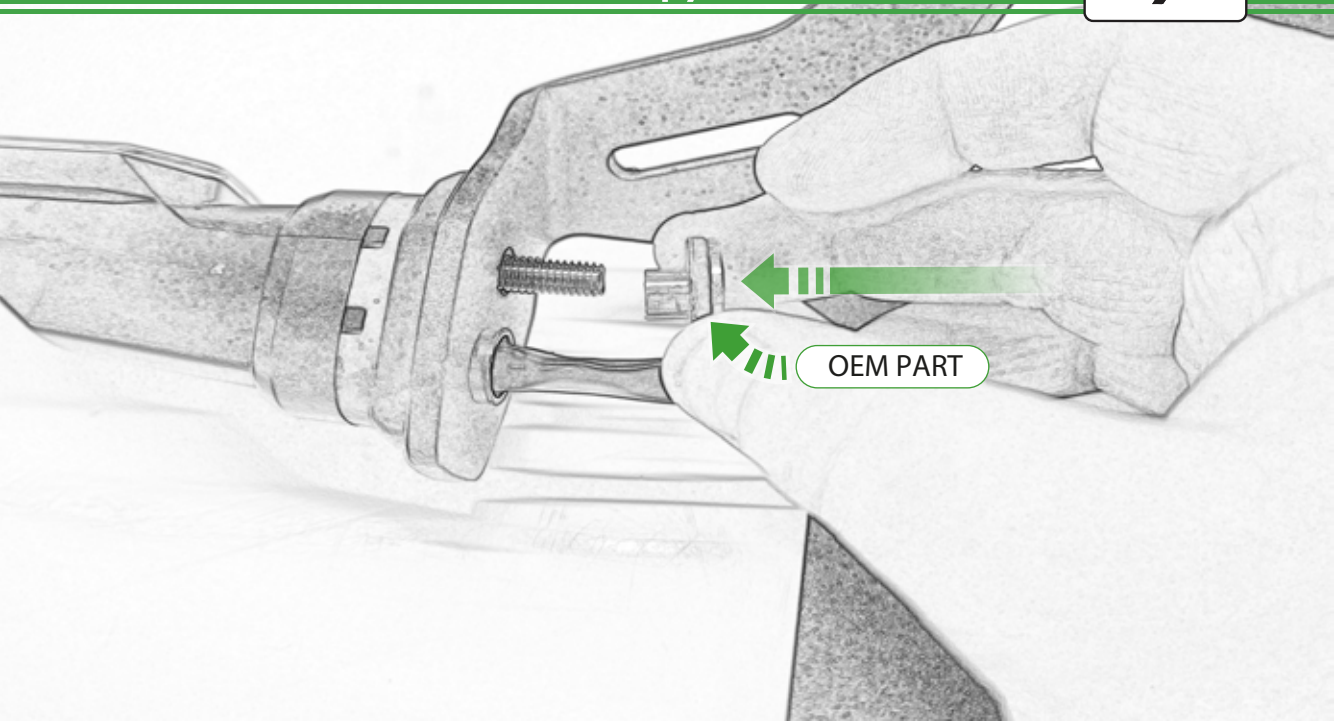

OEM PART

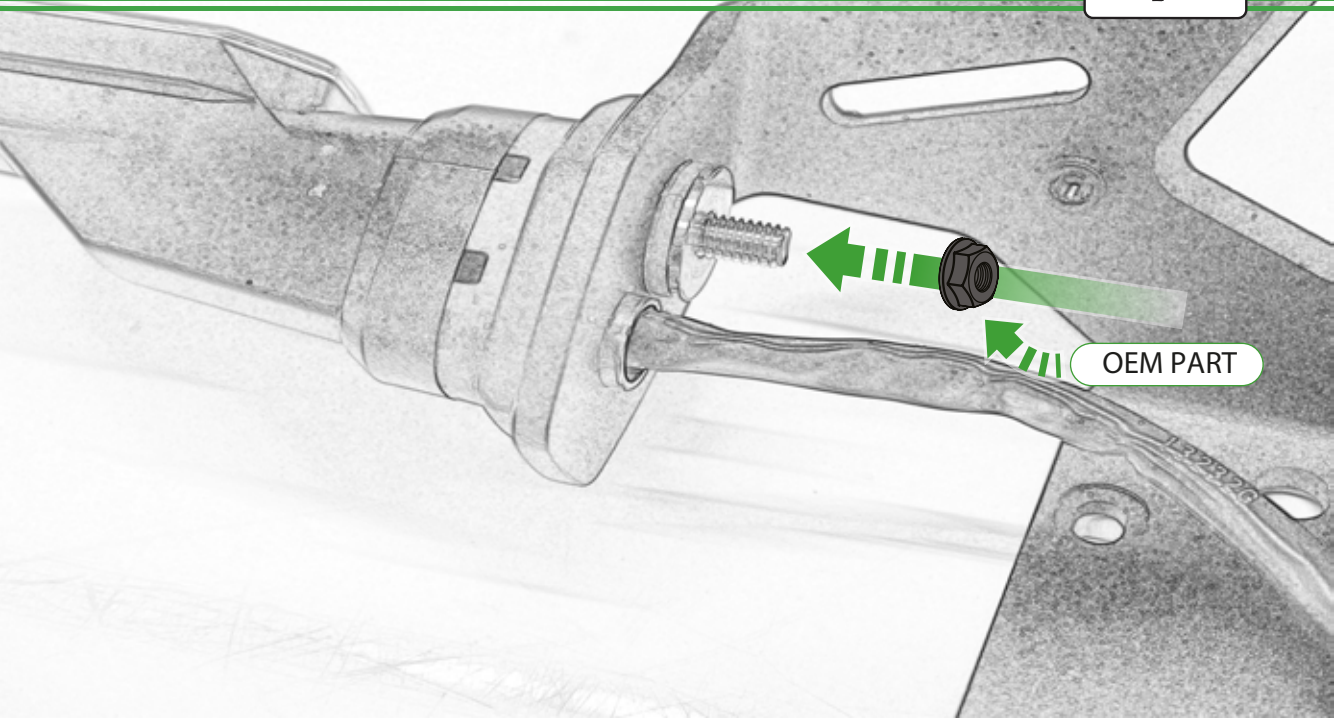

OEM PART

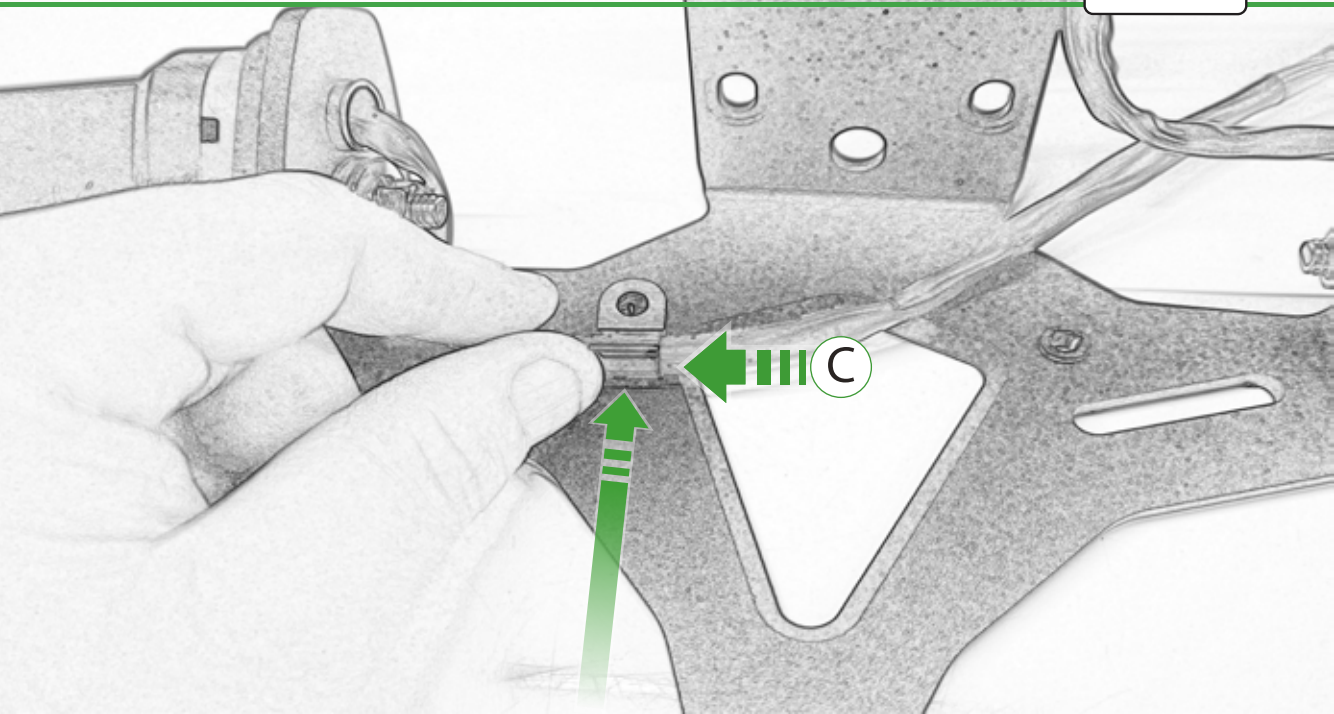

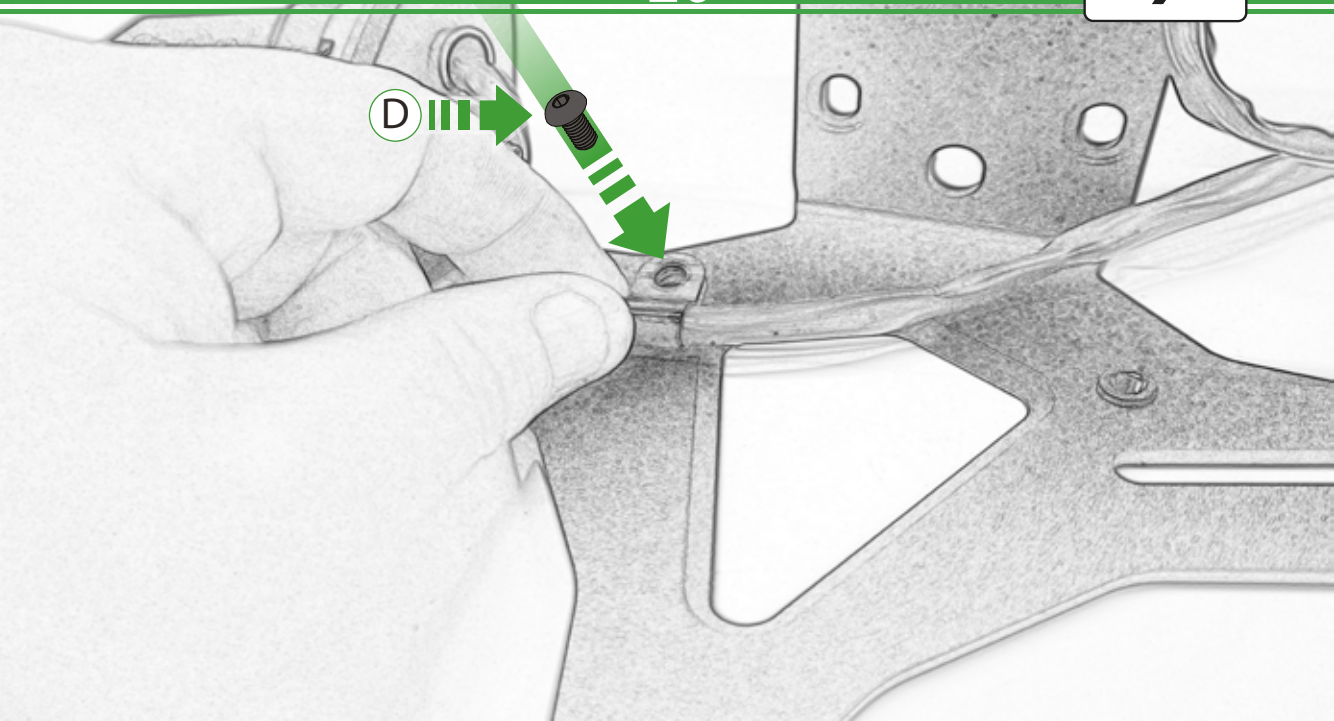

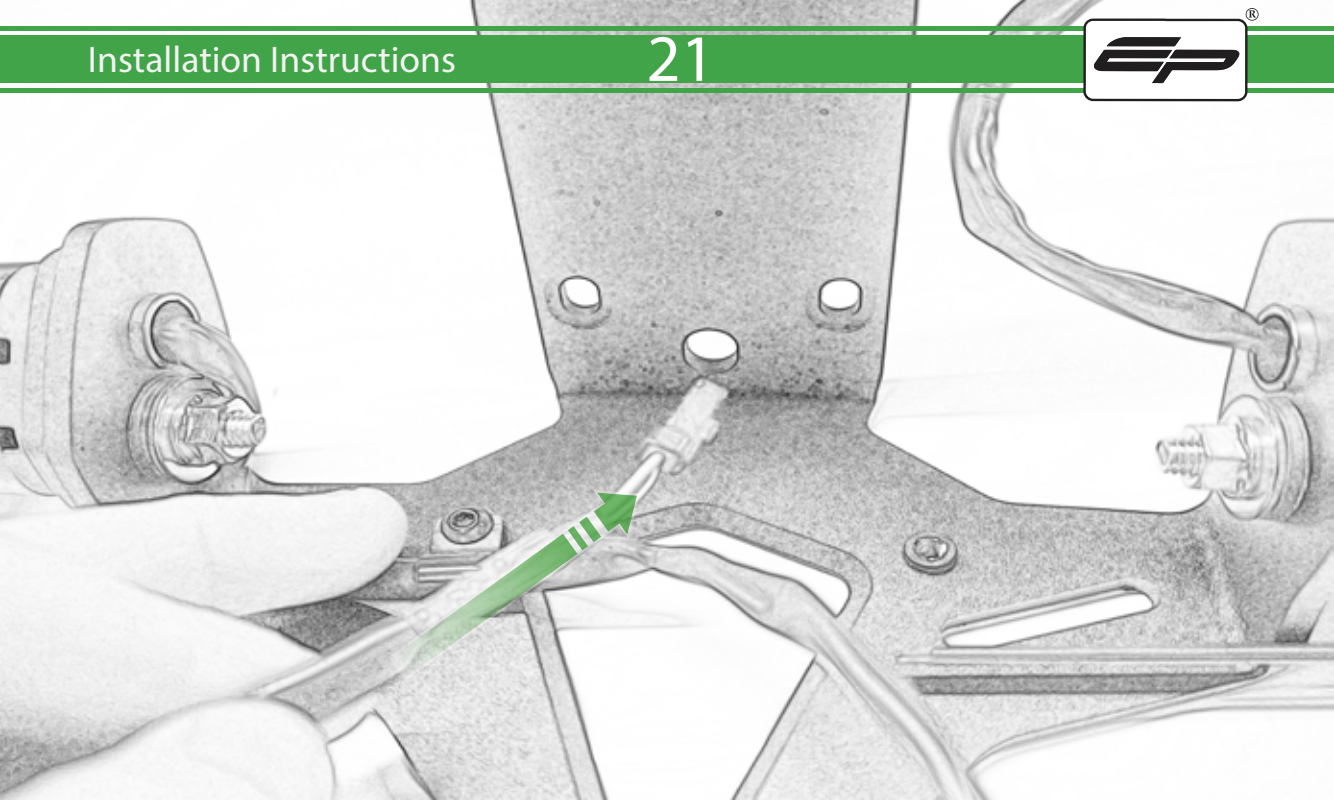

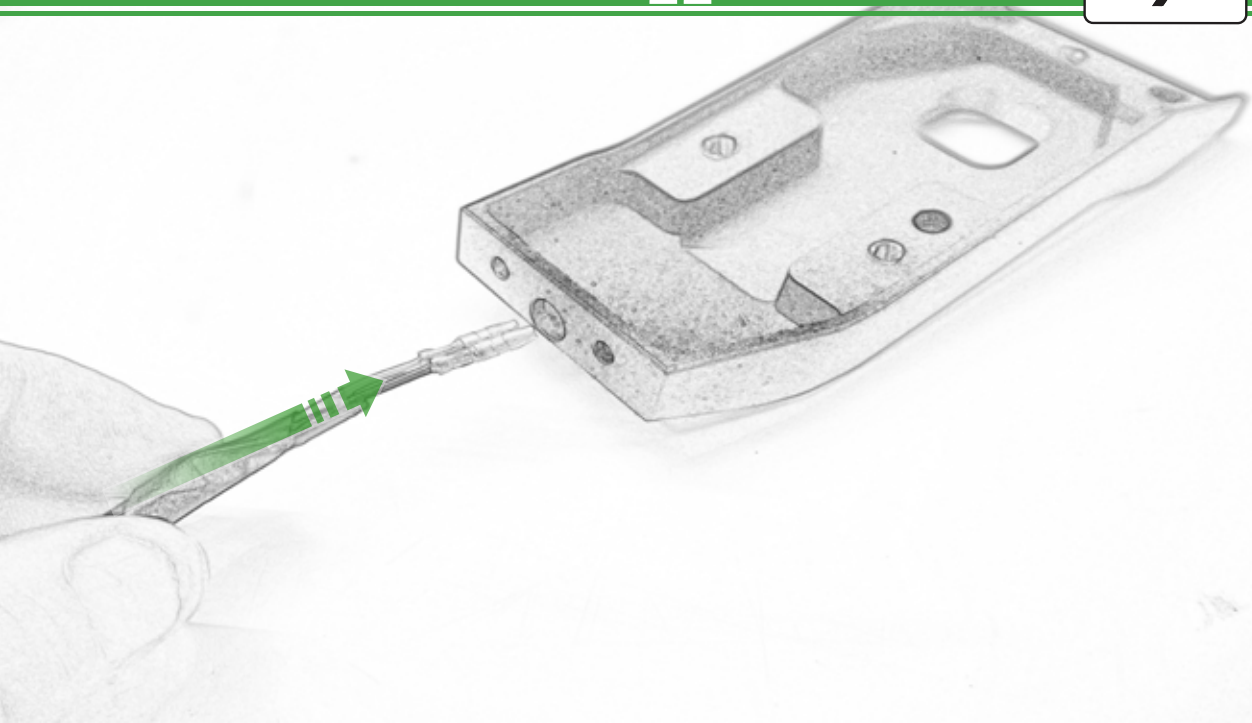

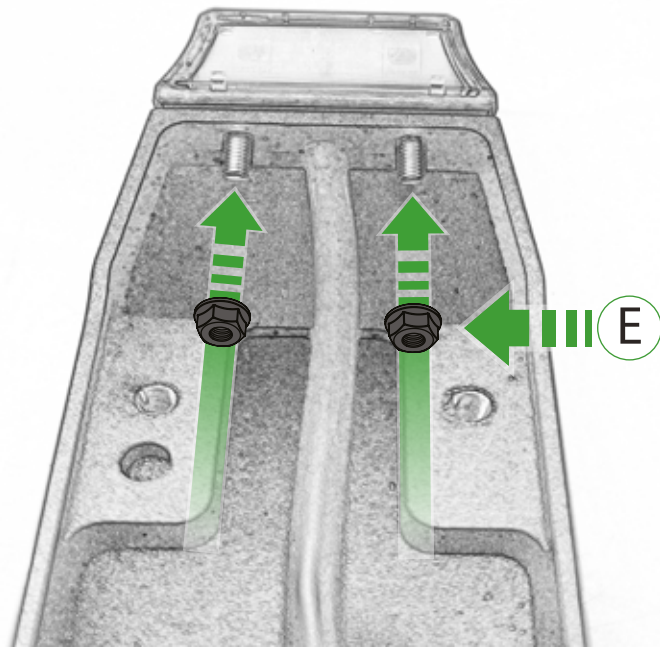

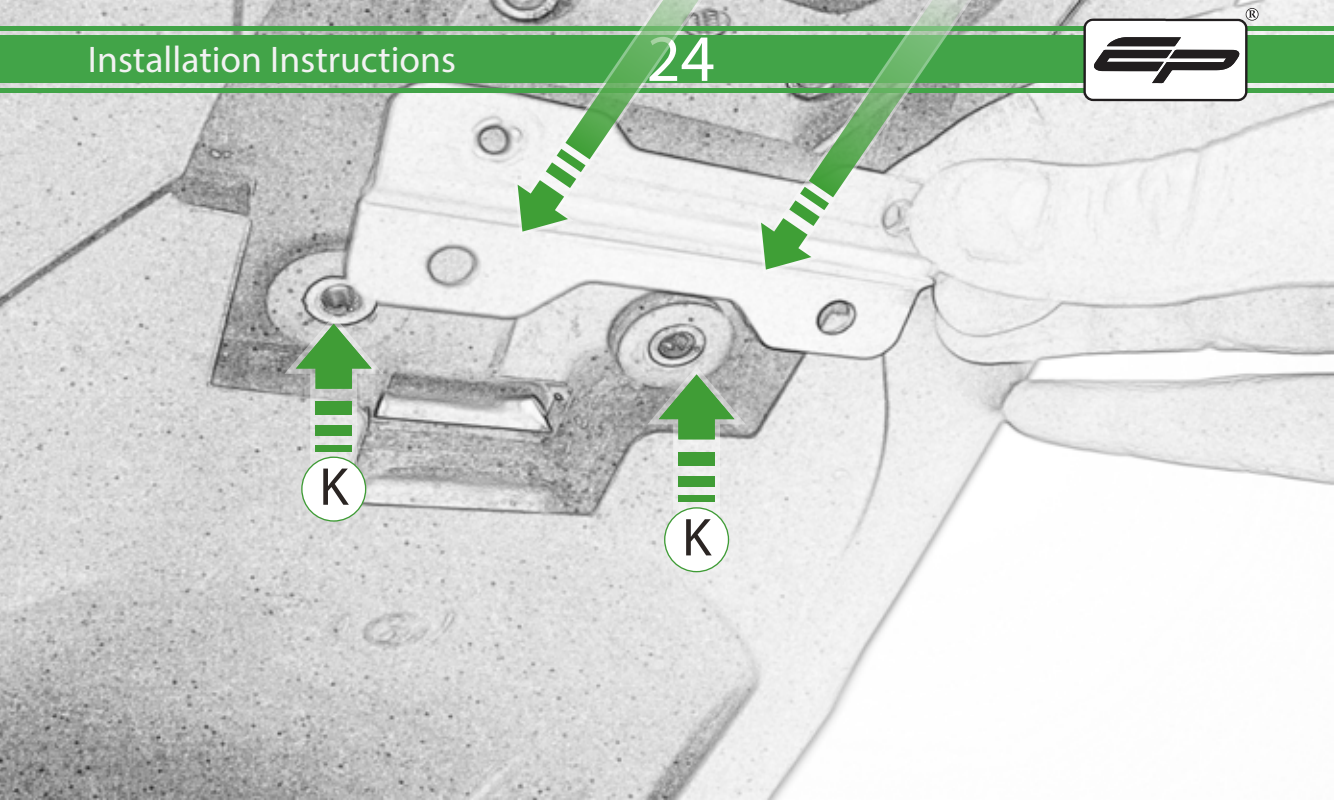

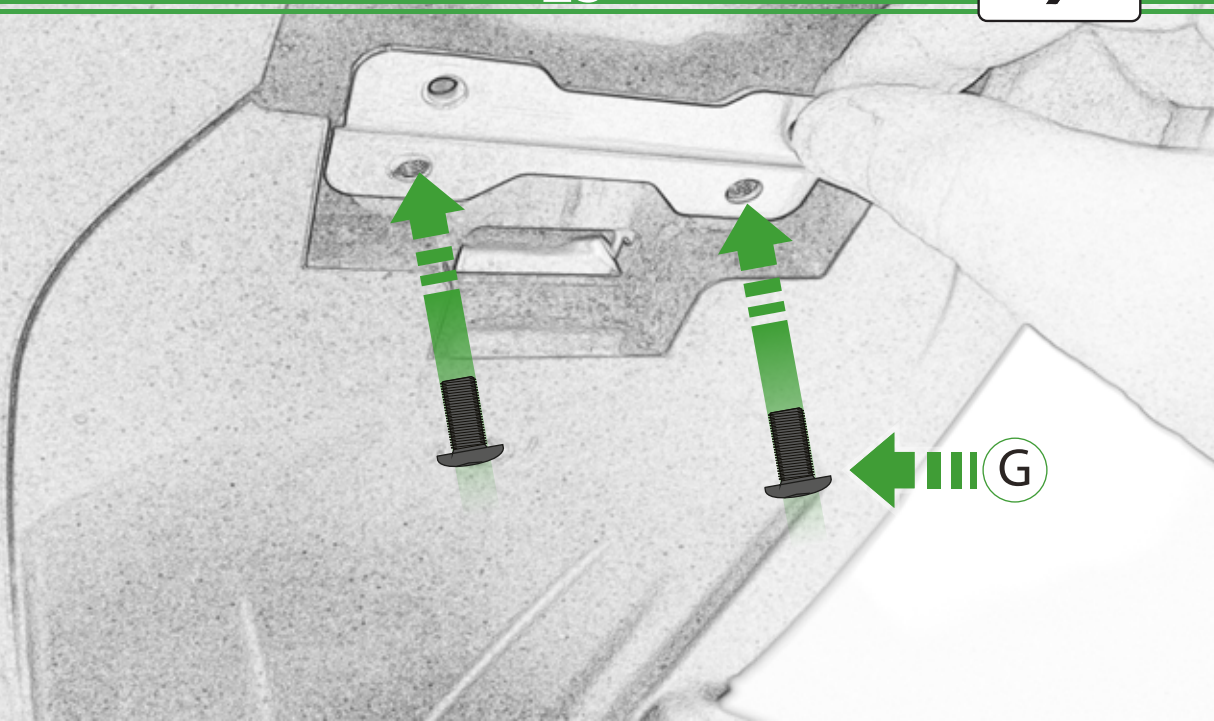

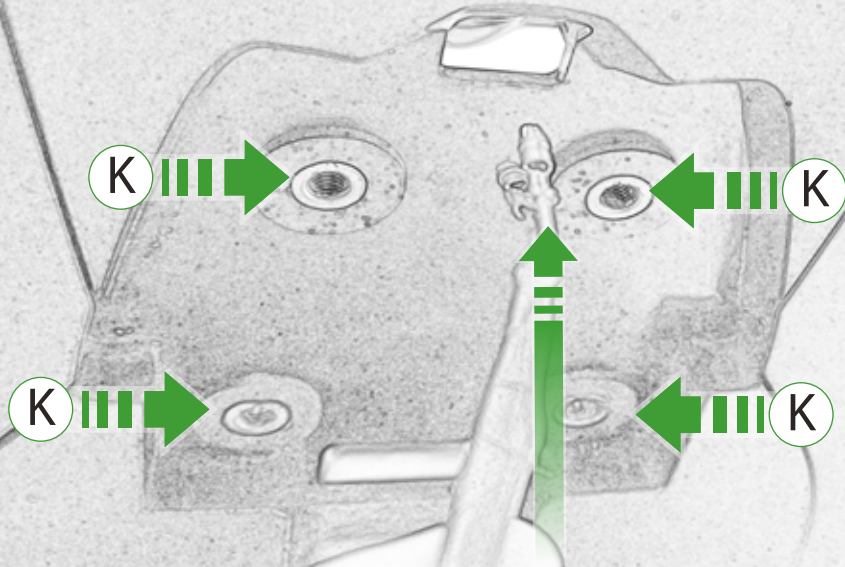

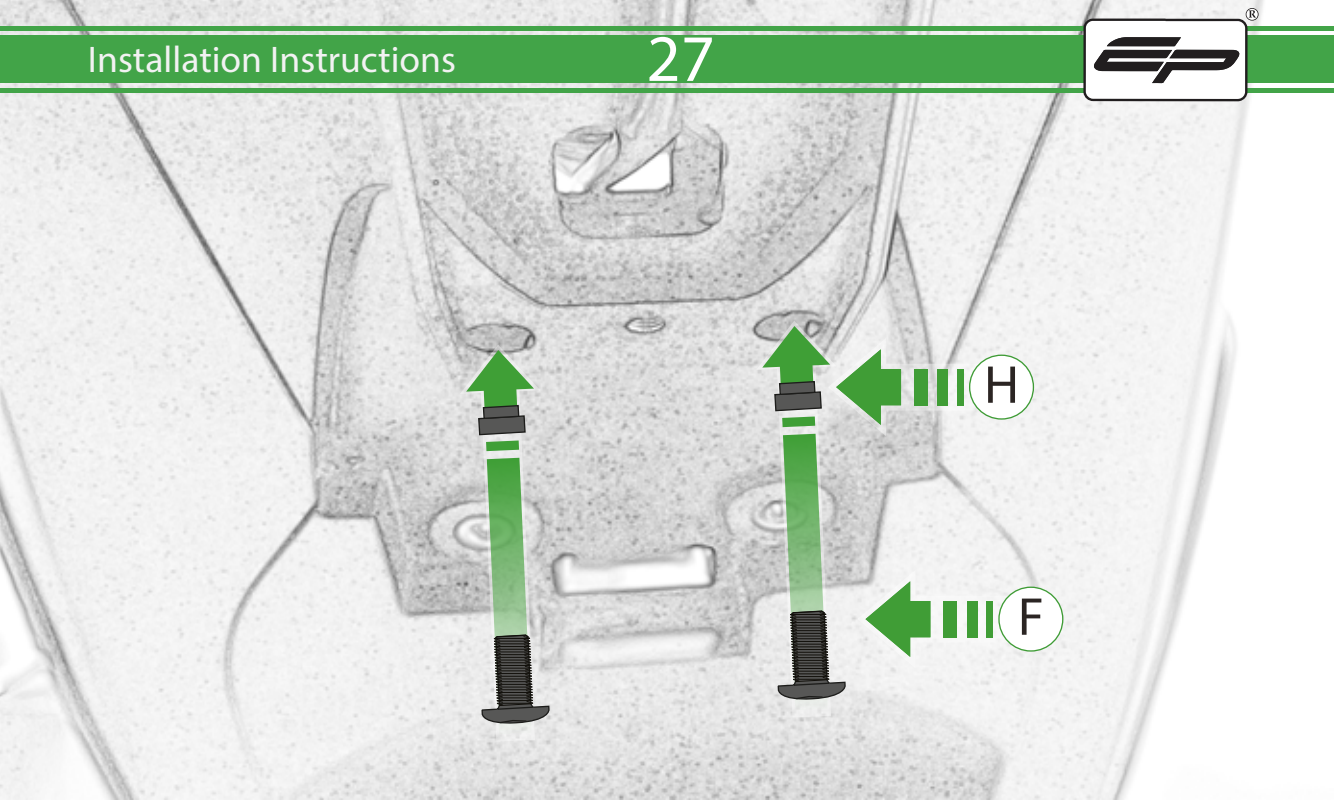

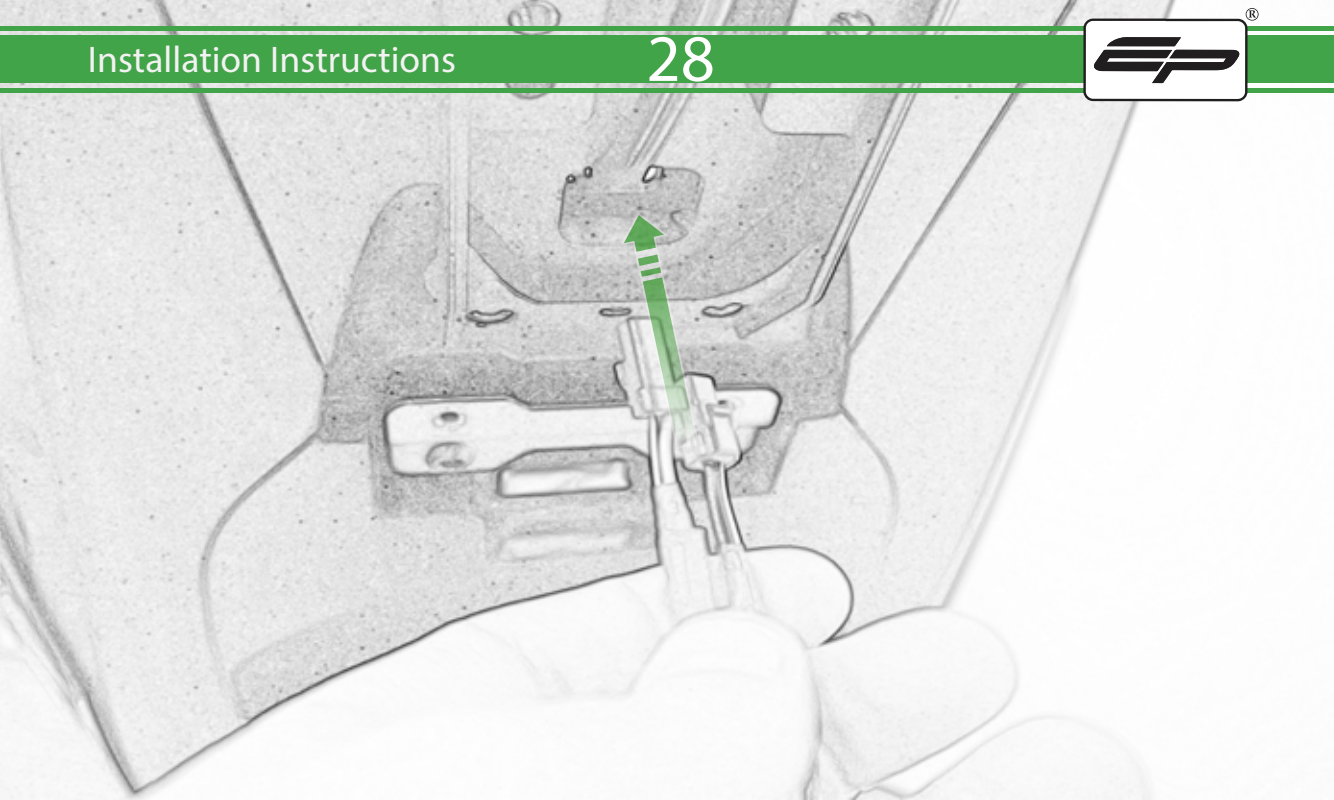

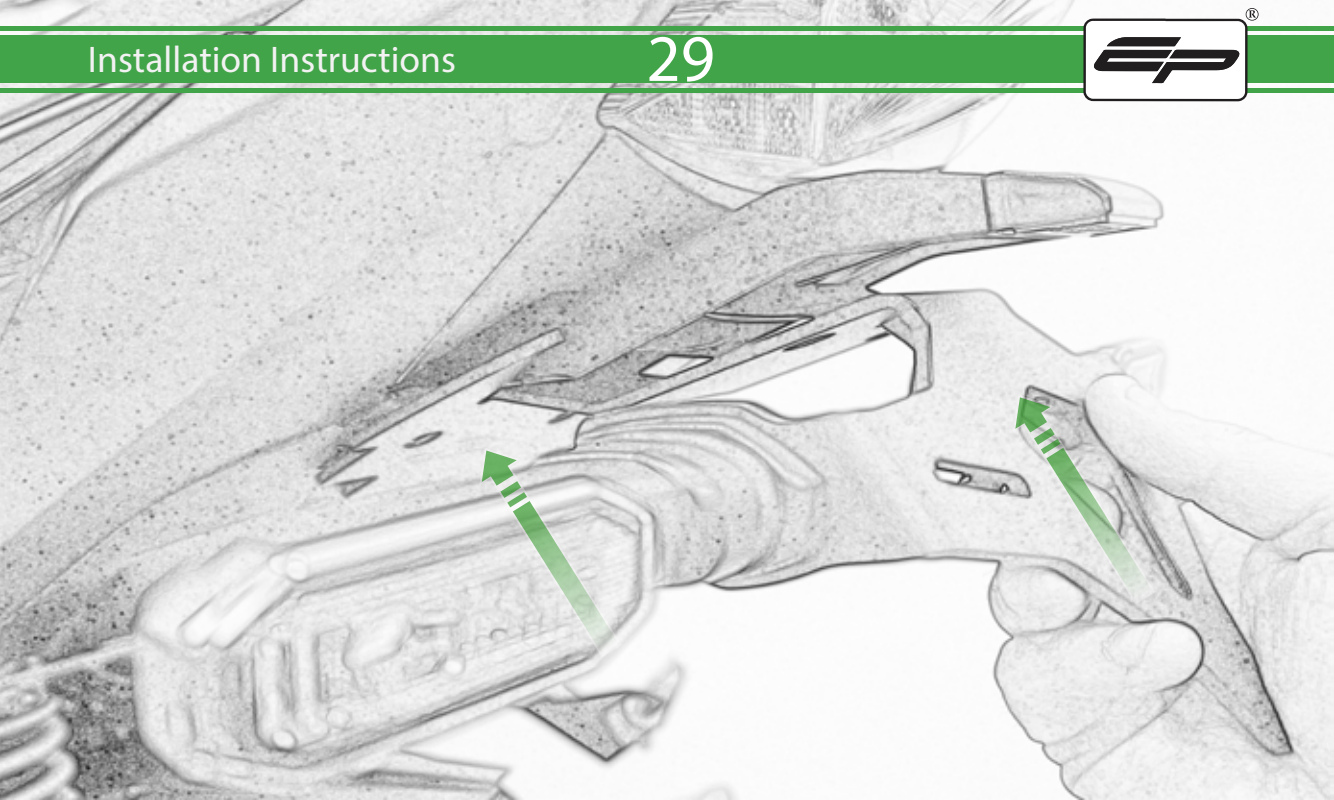

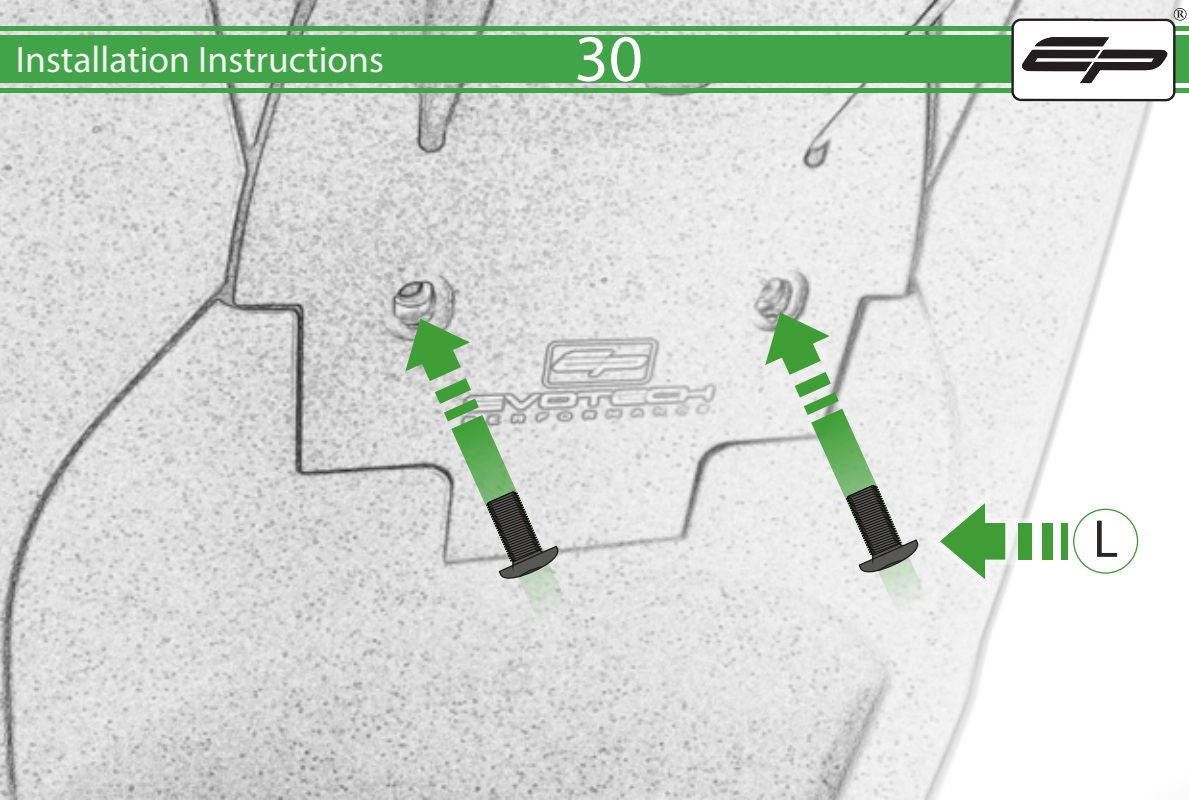

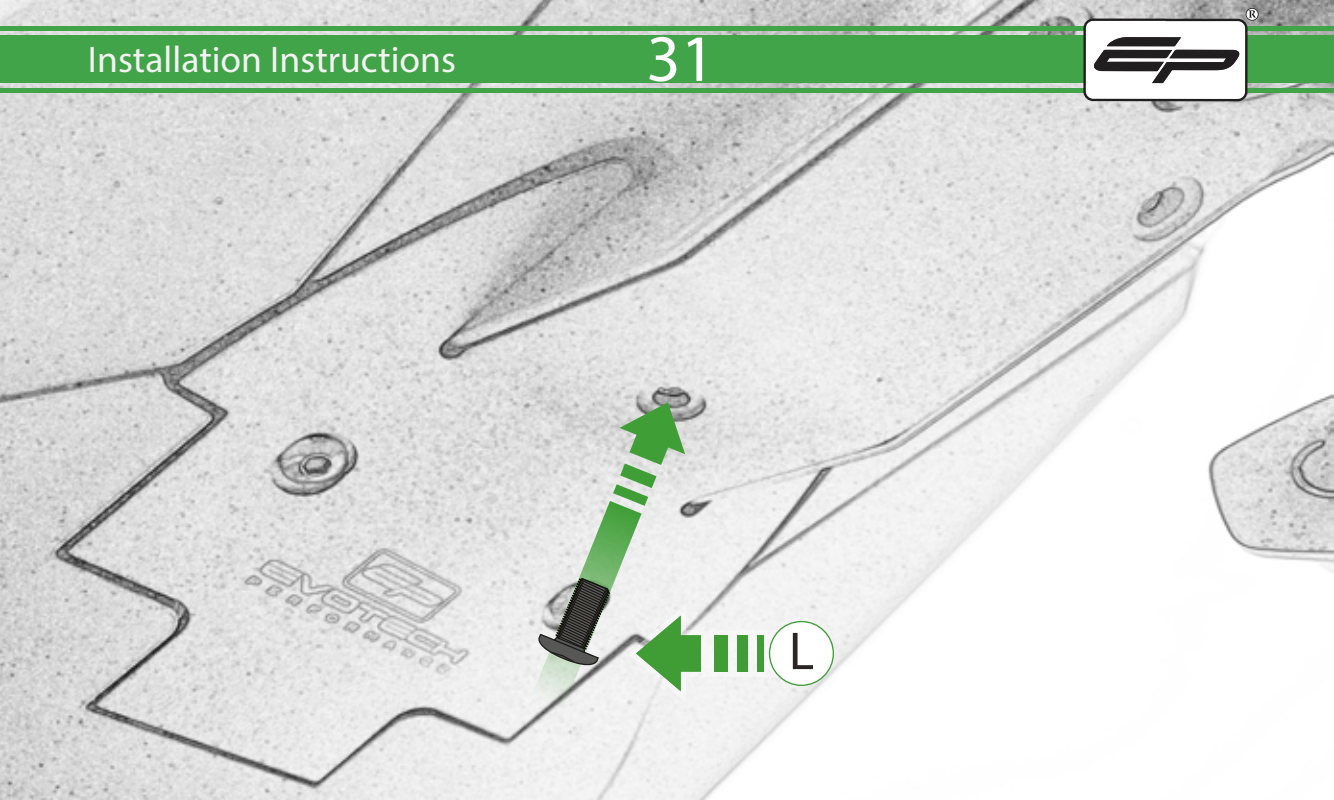

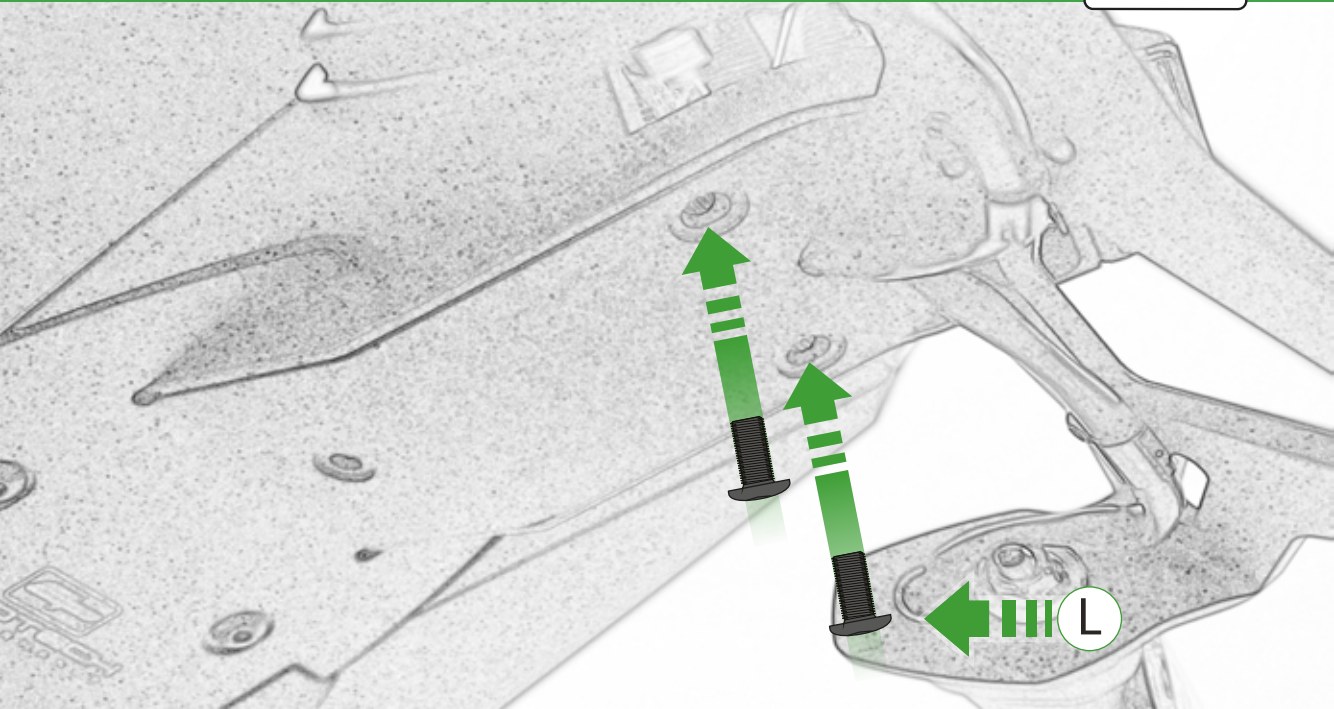

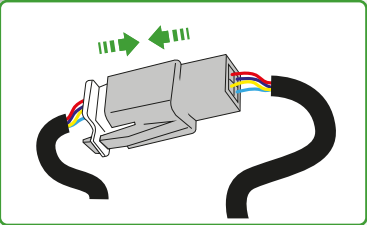
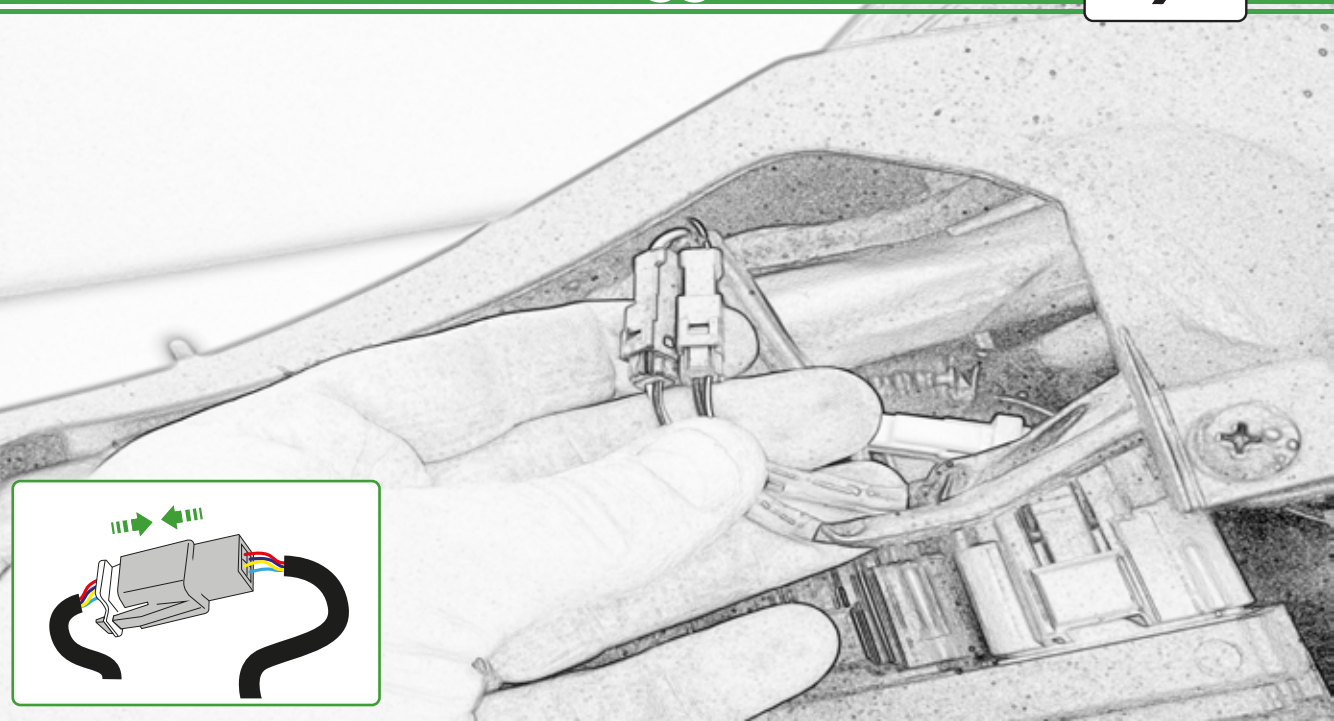

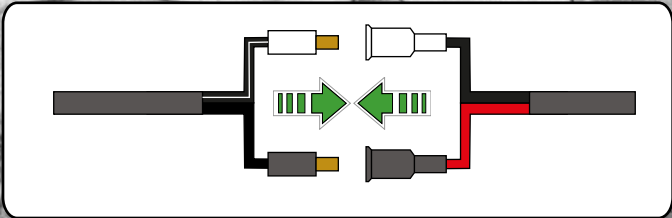
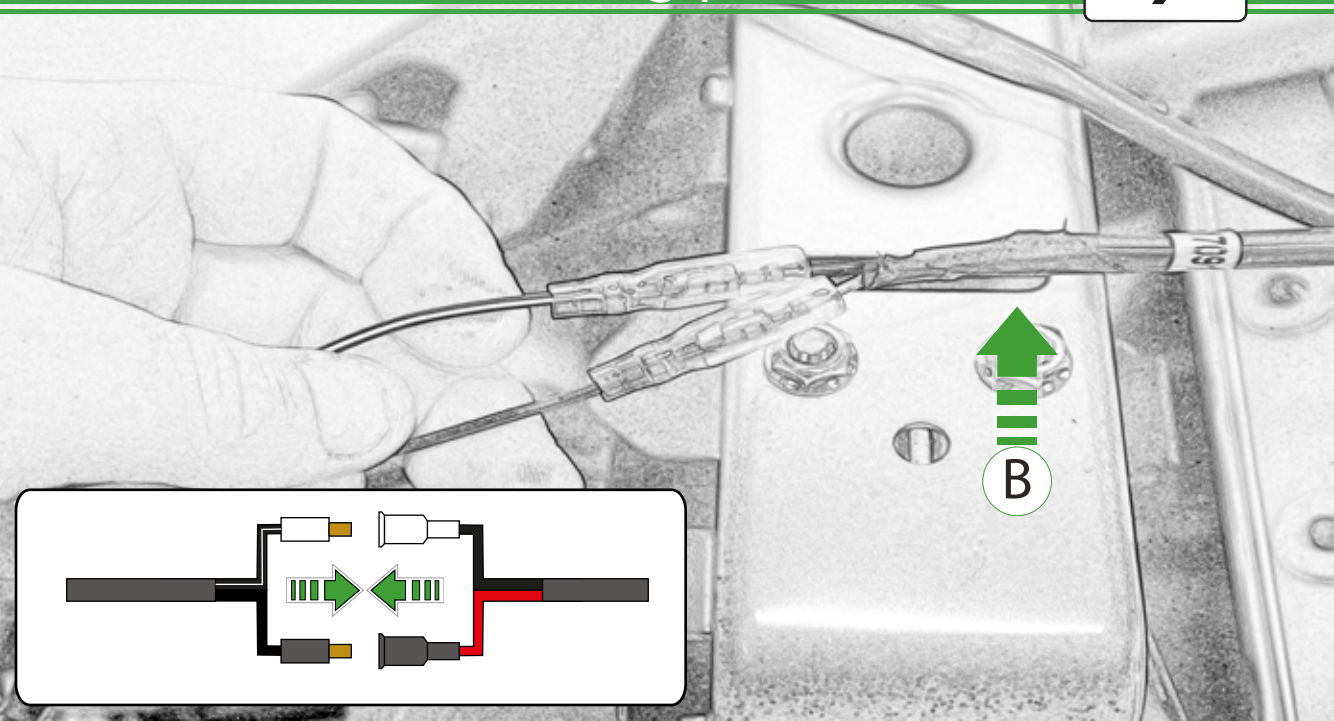

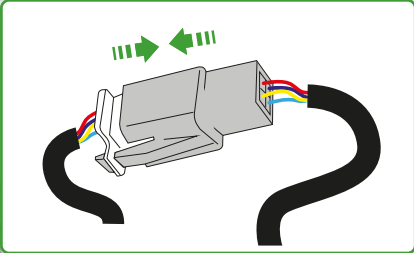
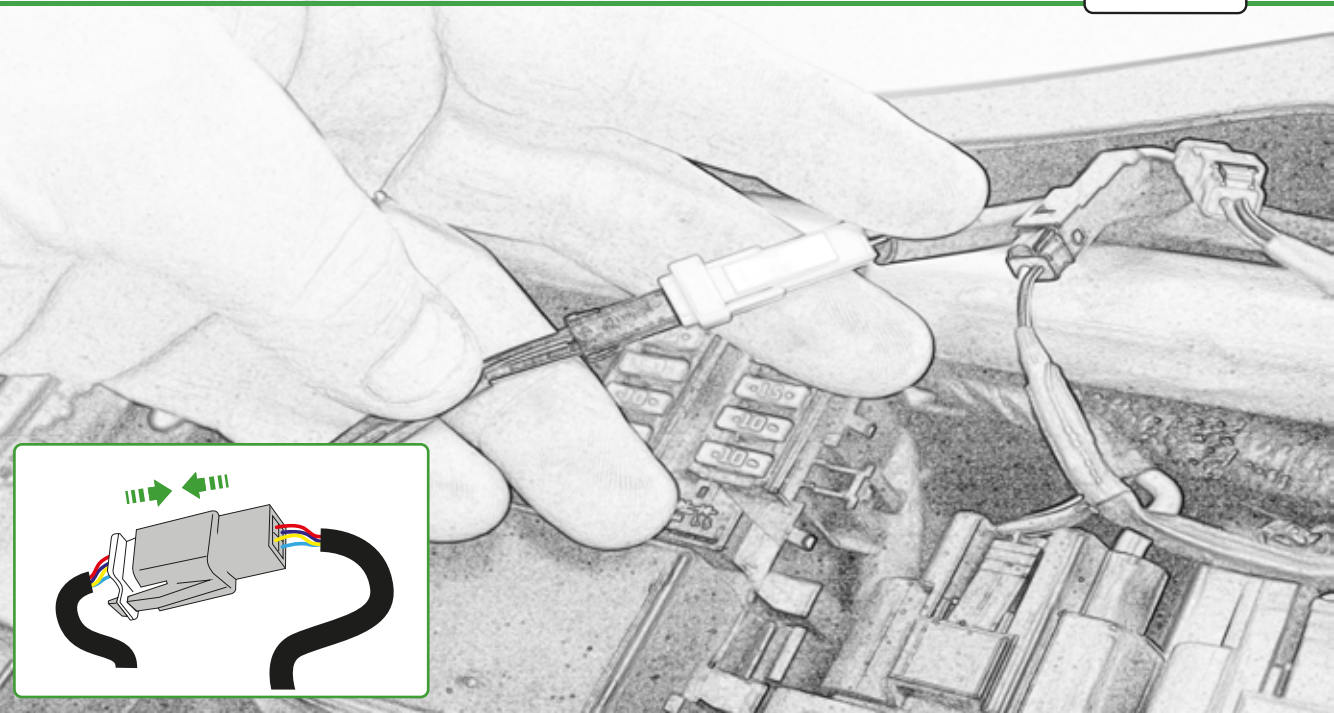

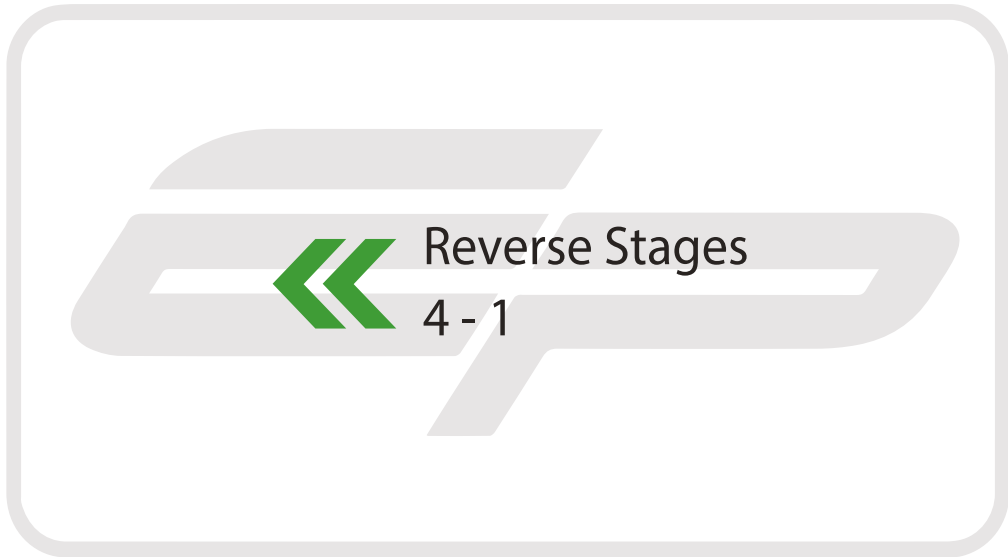

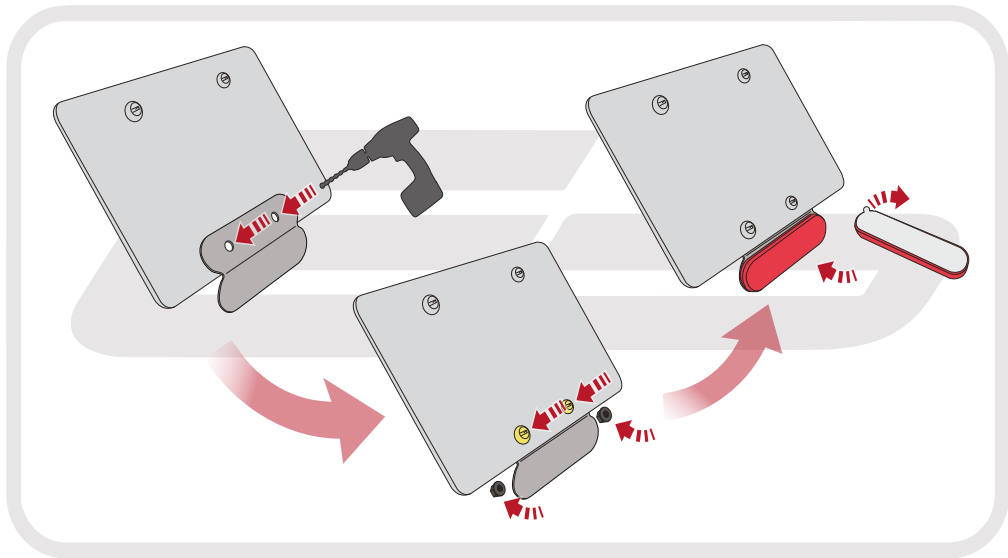

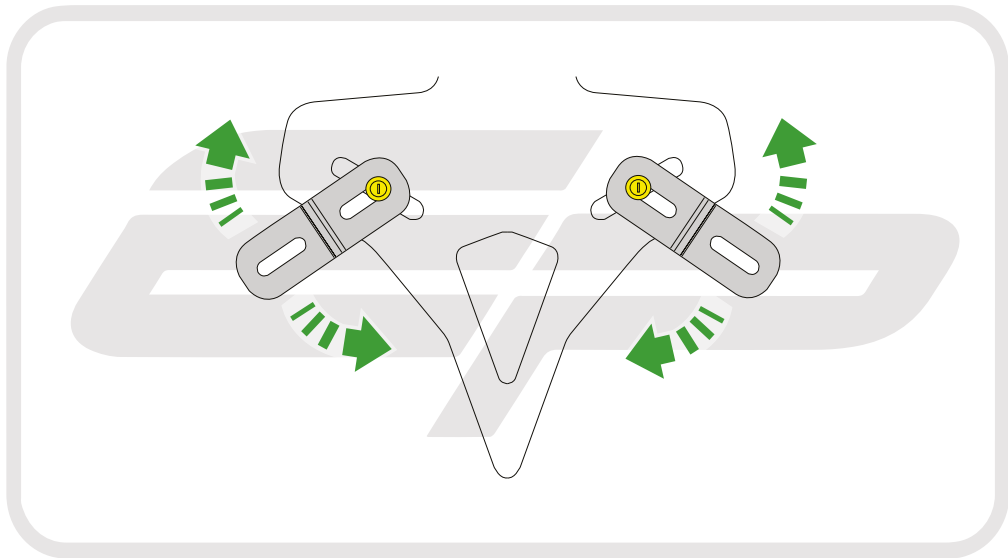



ESSENTIAL CHECKS

After installation of your tail tidy ensure that the licence plate does not contact the rear tyre when suspension is fully compressed.

Ensure all electrics including indicators, tail light, brake light and licence plate light lights are working correctly before riding the motorcycle.

It is recommended that periodic inspections are made to ensure that all fixings are fully tightend.



EVOTECH®
P E R F O R M A N C E

www.evotech-performance.com