



EVOTECH®
P E R F O R M A N C E

www.evotech-performance.com

BMW S 1000 RR

Tail Tidy Instructions

Kit Contents PRN014343

- (A) 1 x Rubber Bung
- (B) 1 x Retro Light
- (C) 1 x Loom Connector
- (D) 1 x Mounting Bracket
- (E) 2 x M4 Flange Nuts
- (F) 2 x Indicator Spacers
- (G) 2 x M6 x 16 Black Button Head Bolts
- (H) 2 x M5 x 16 Caphead
- (I) 2 x M5 x 16 Black Button Head Bolts
- (J) 3 x M5 x 10 Black Button Head Bolts

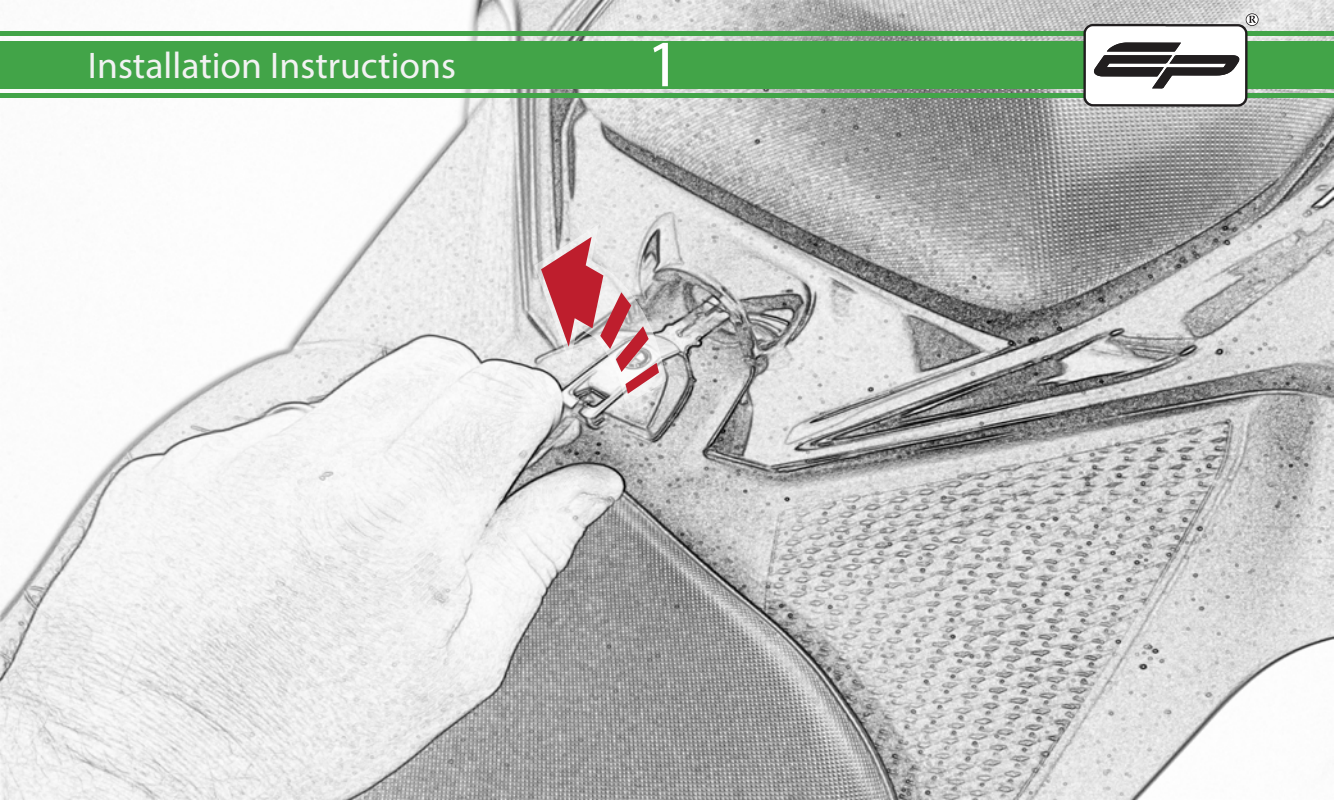

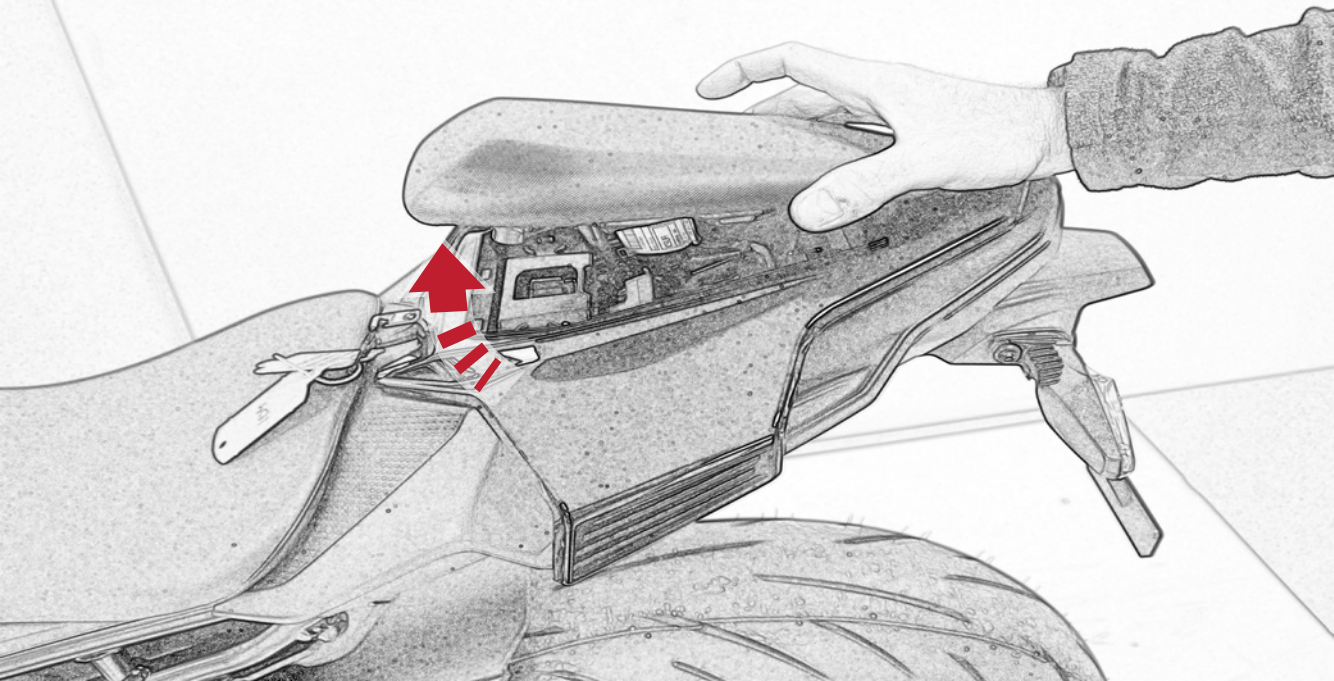

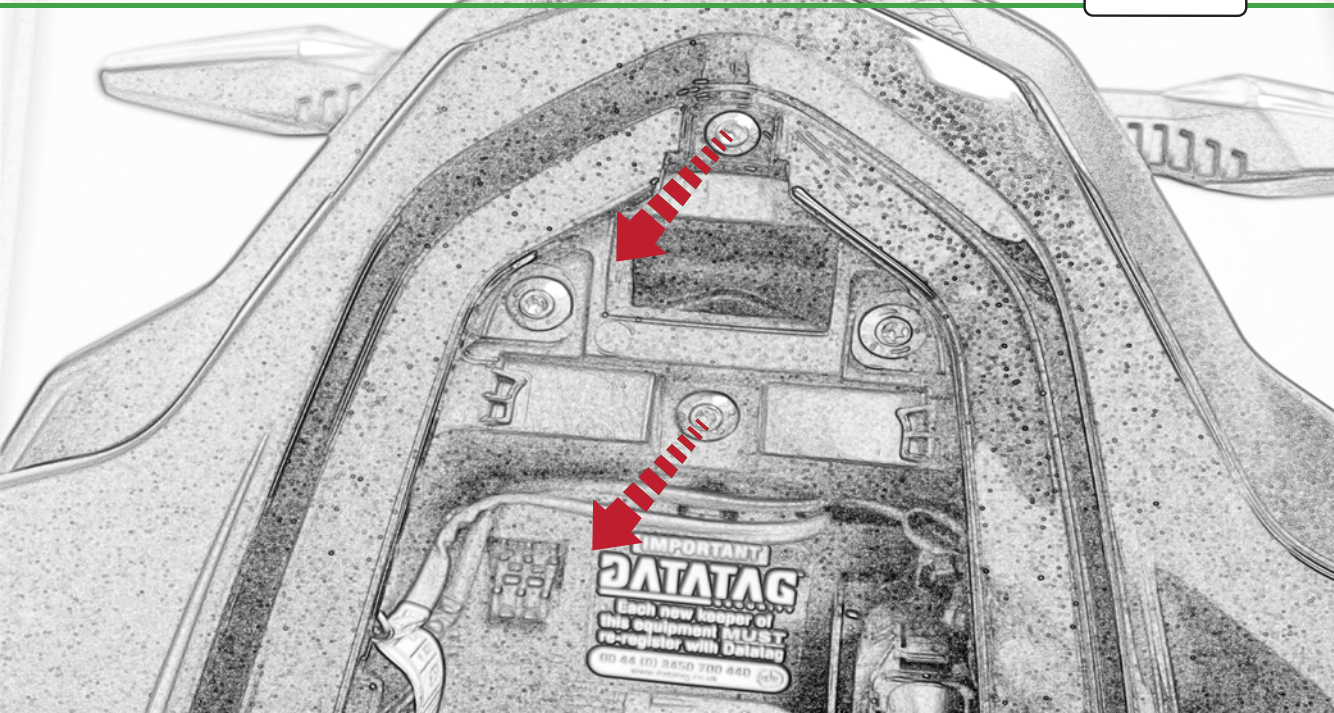

IMPORTANT!
DATATAG
Each new keeper of
this equipment **MUST**
re-register with Datalog
00 44 (0) 3450 700 850 

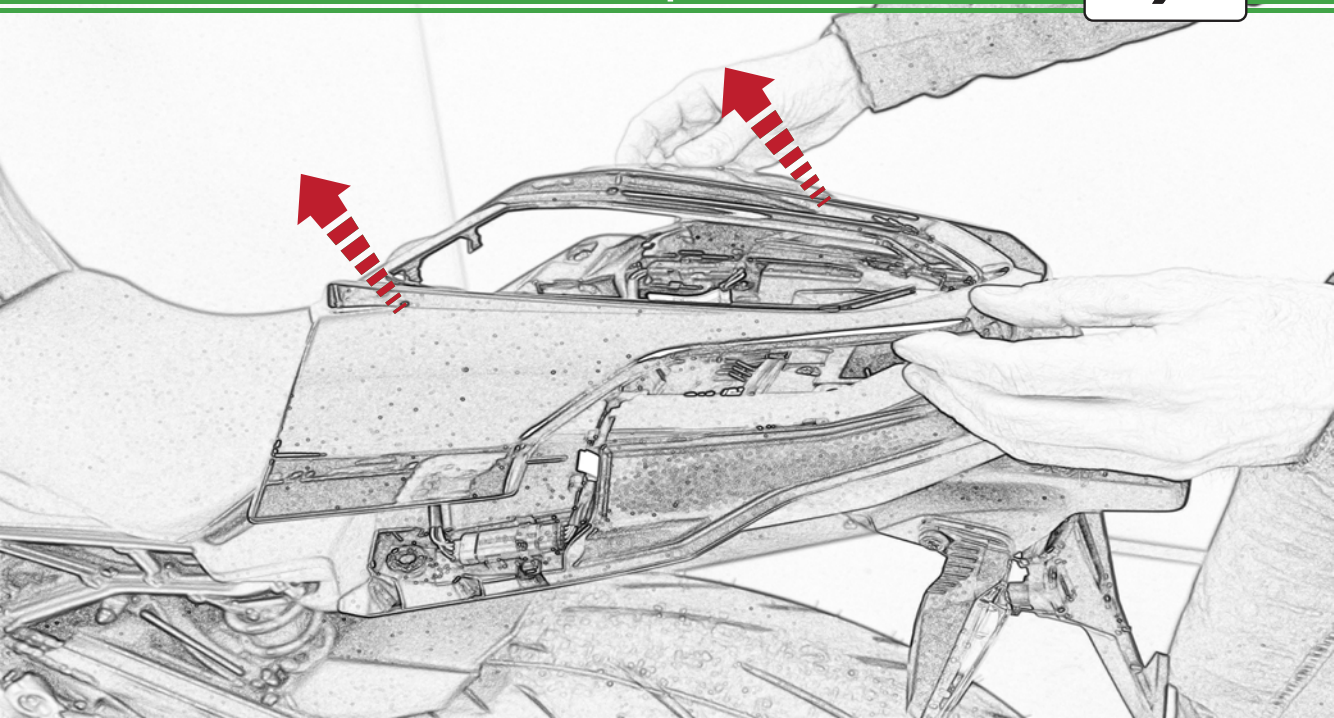

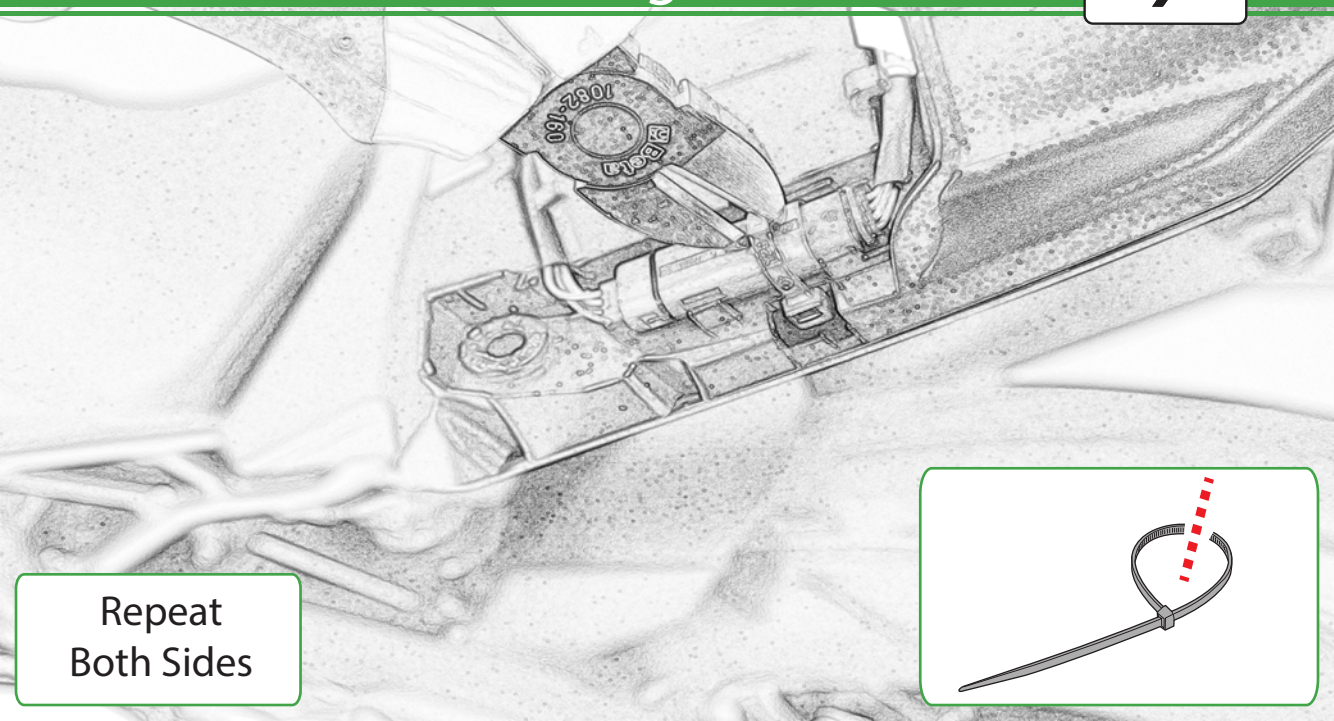

Repeat
Both Sides

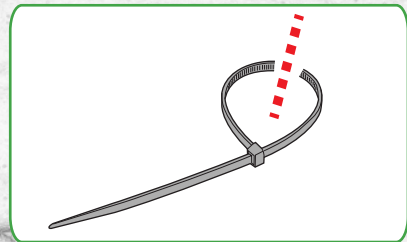

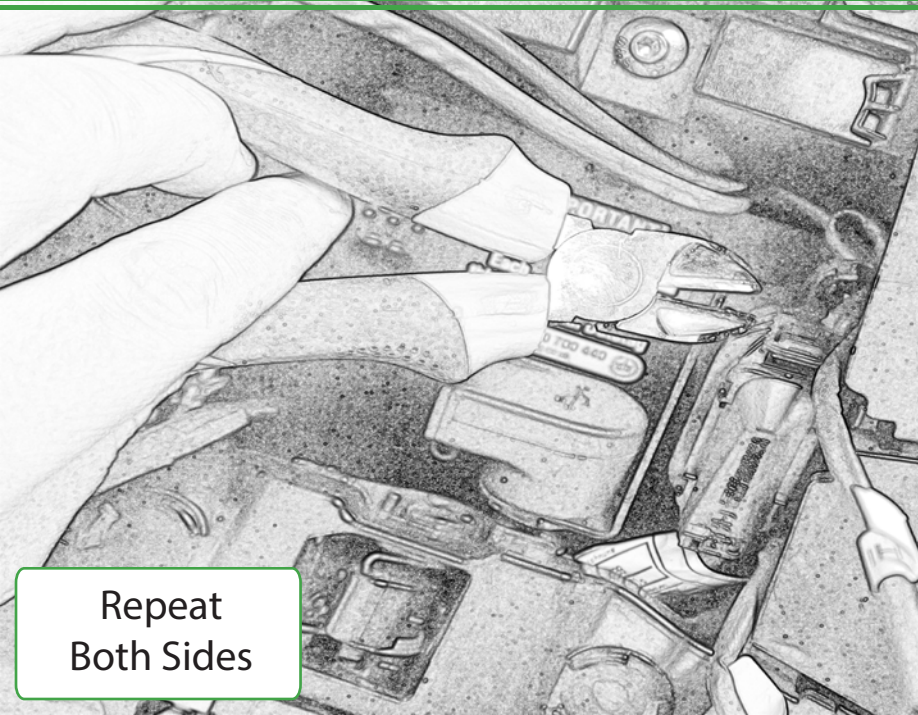

Repeat
Both Sides

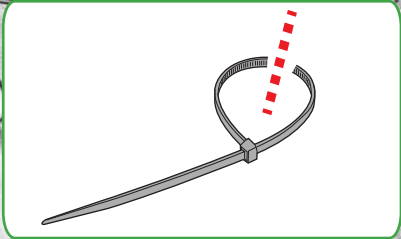

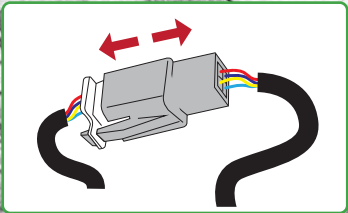
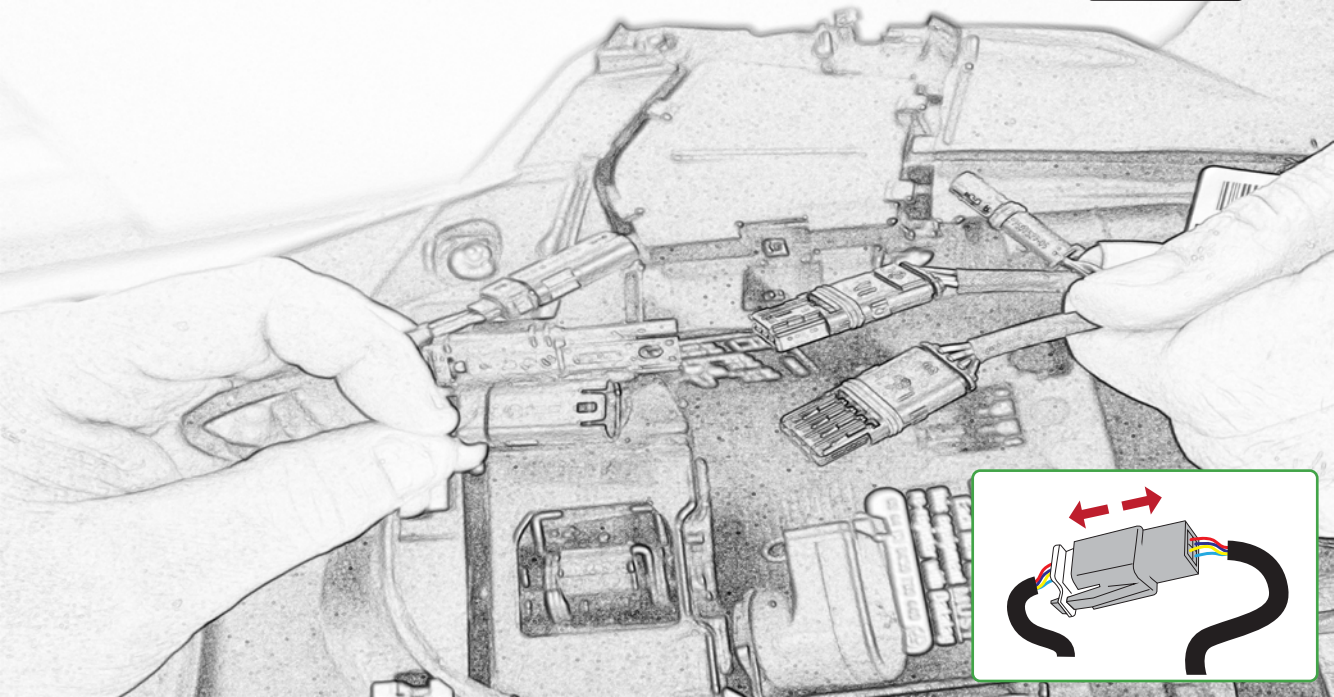

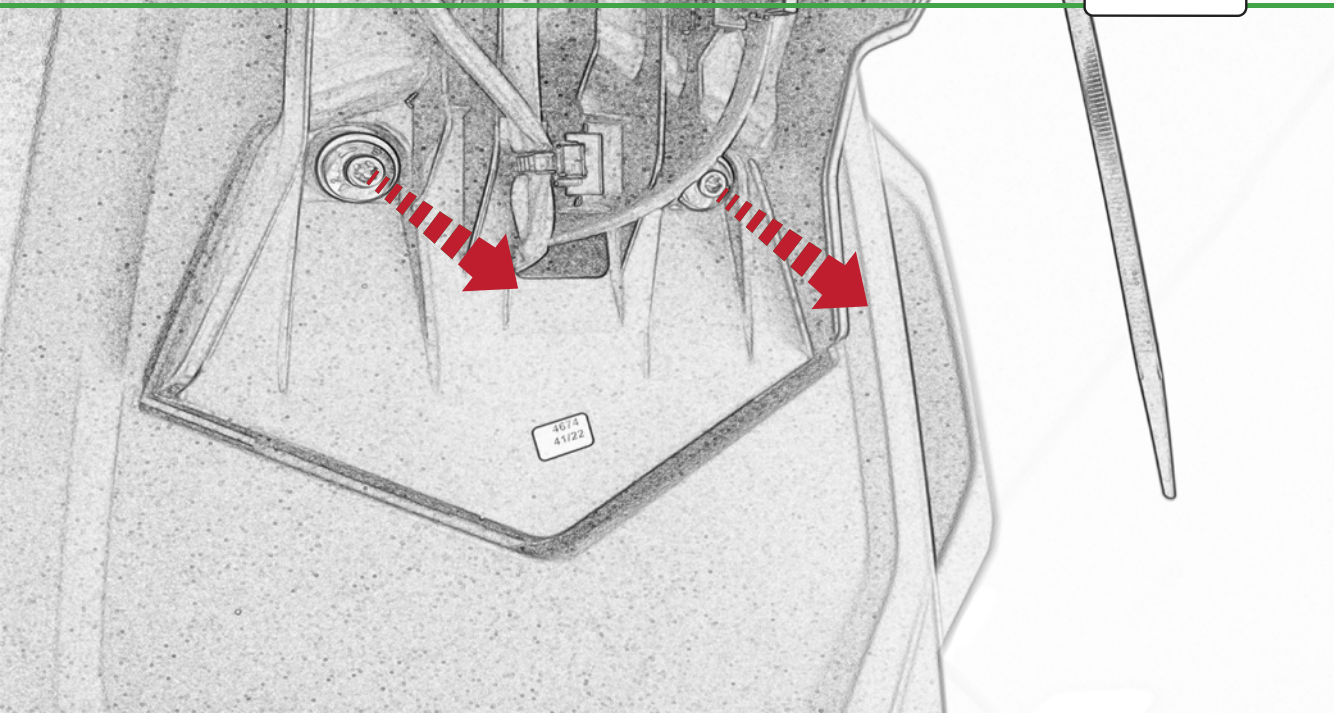

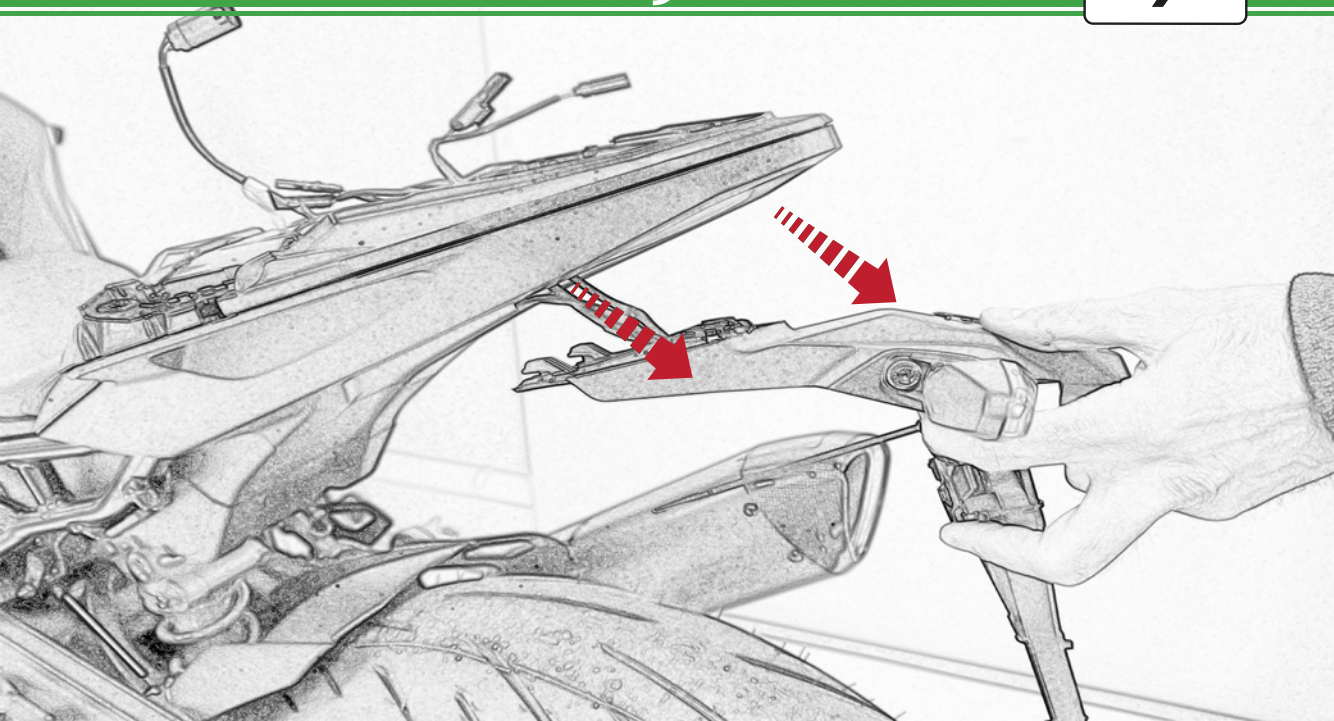

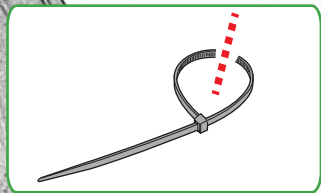
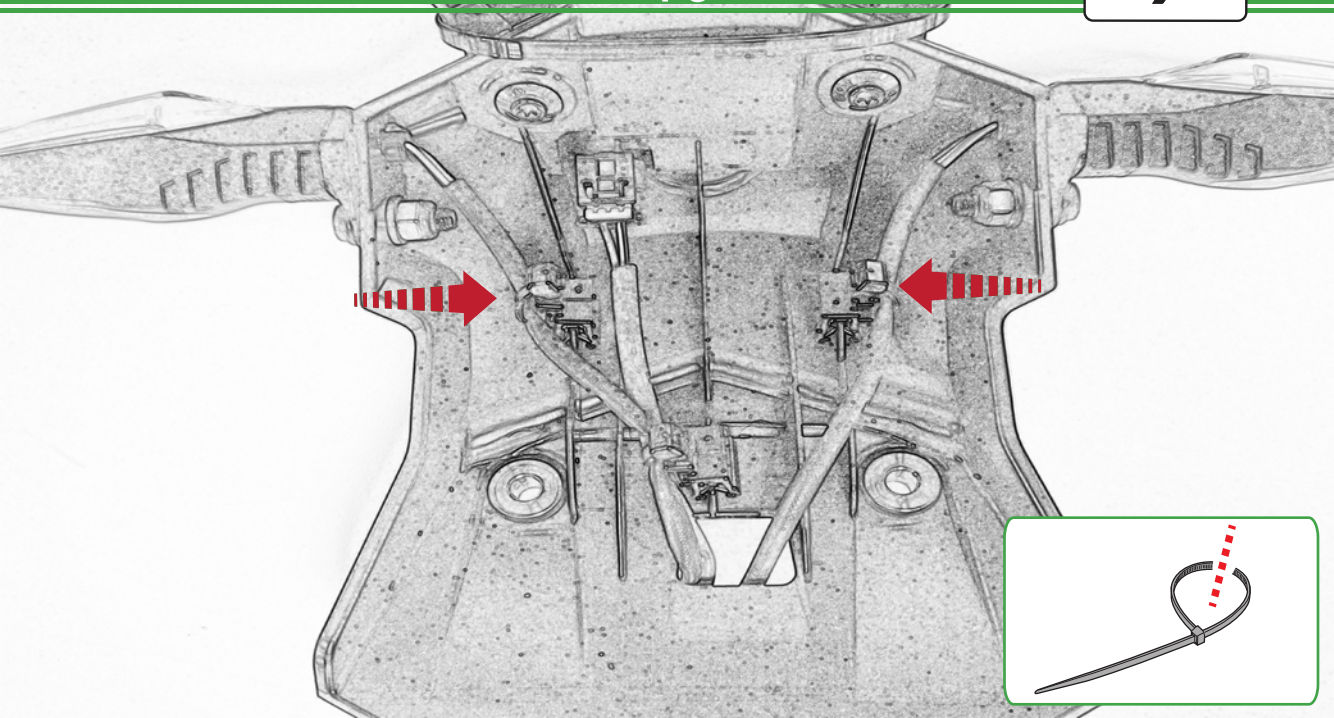

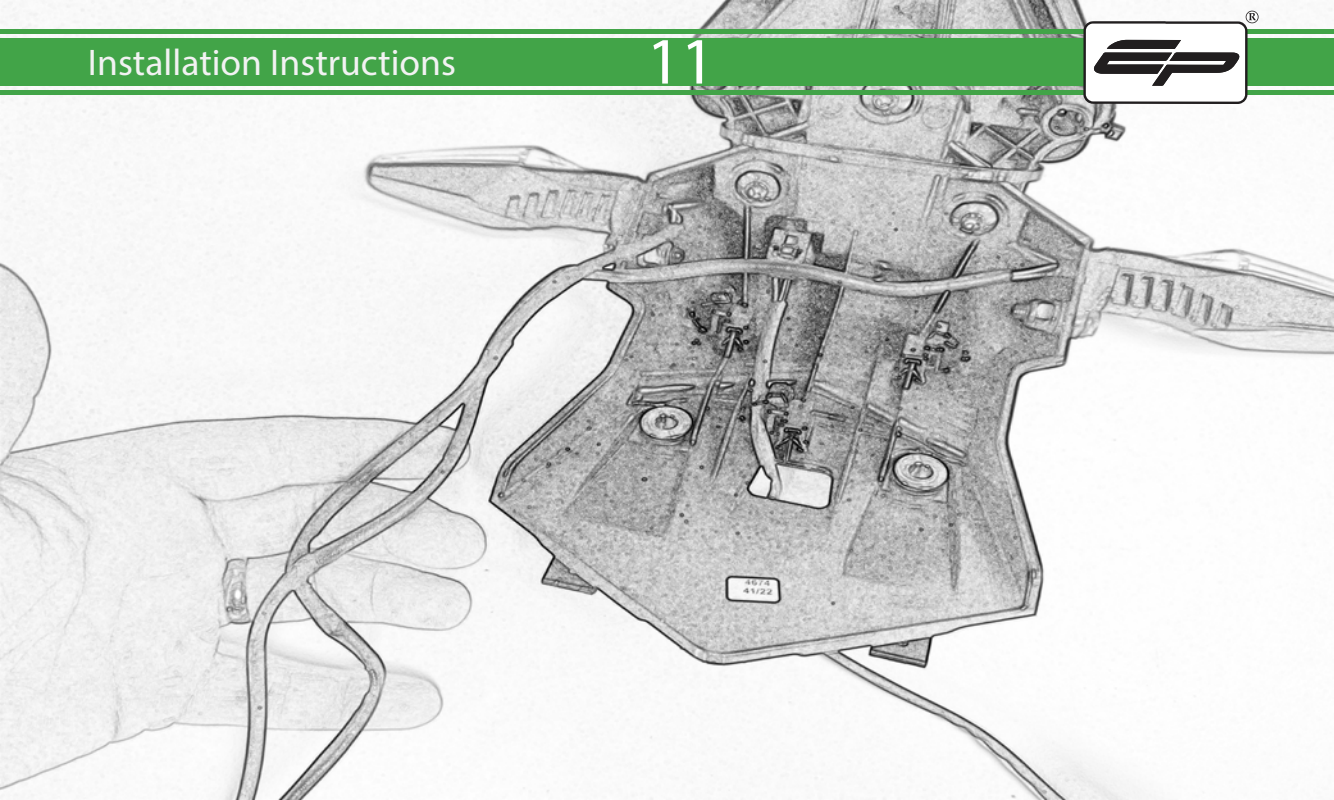

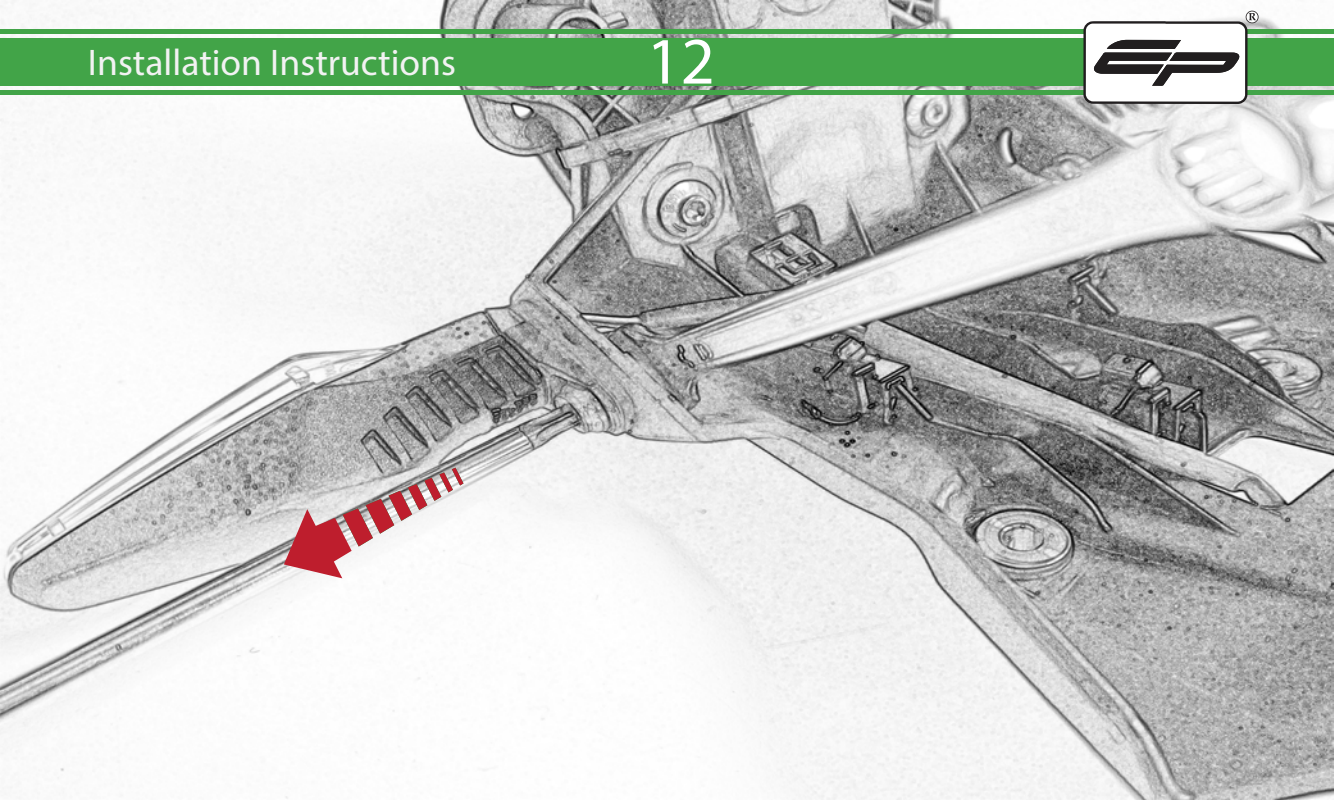

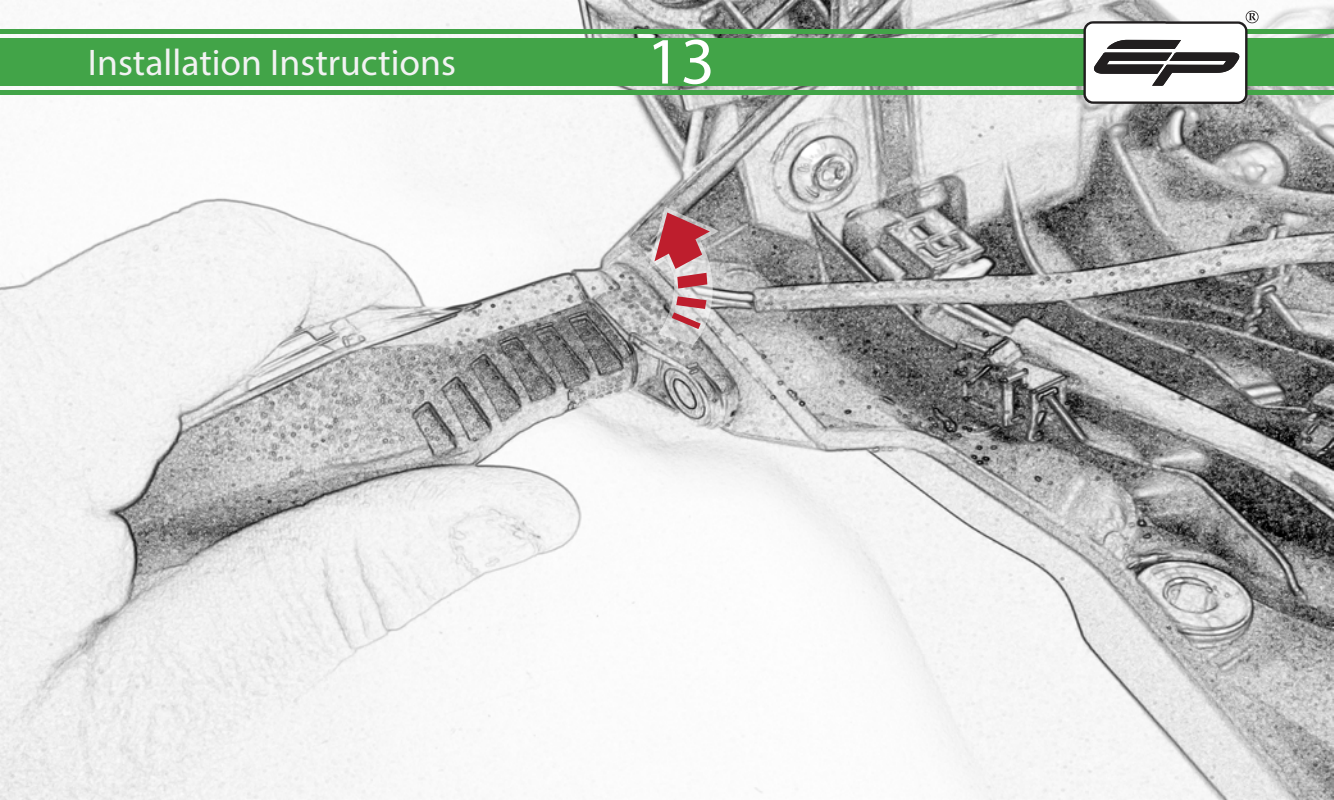

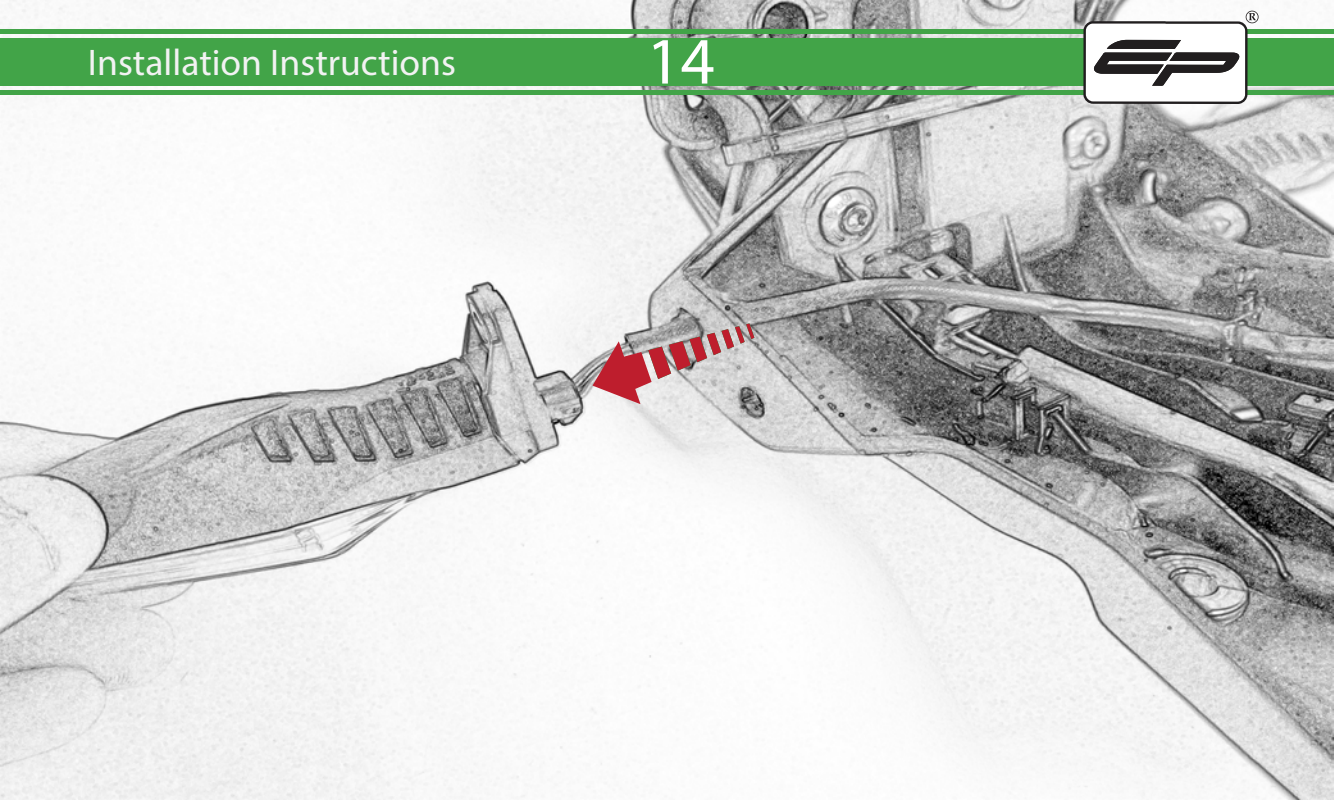

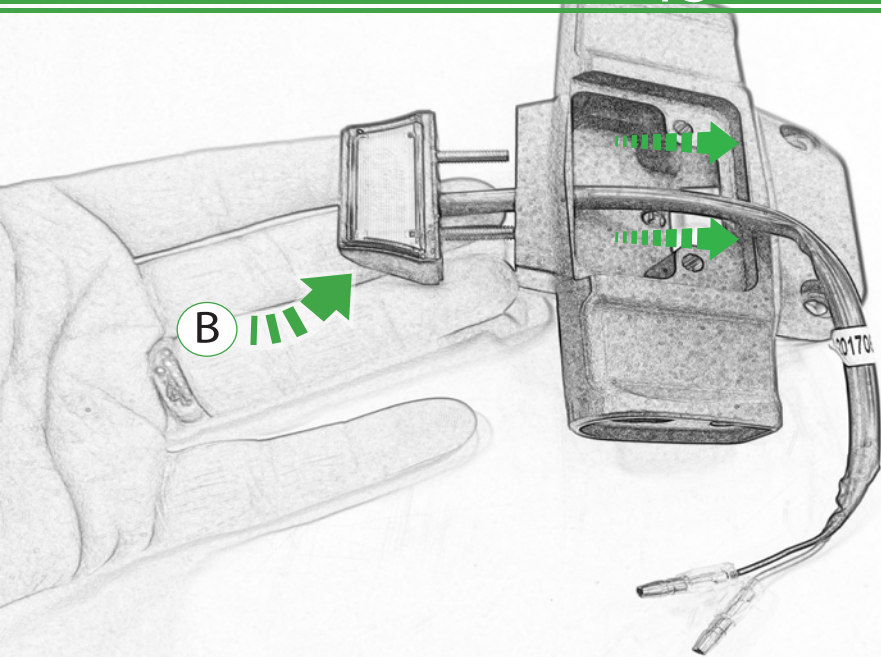

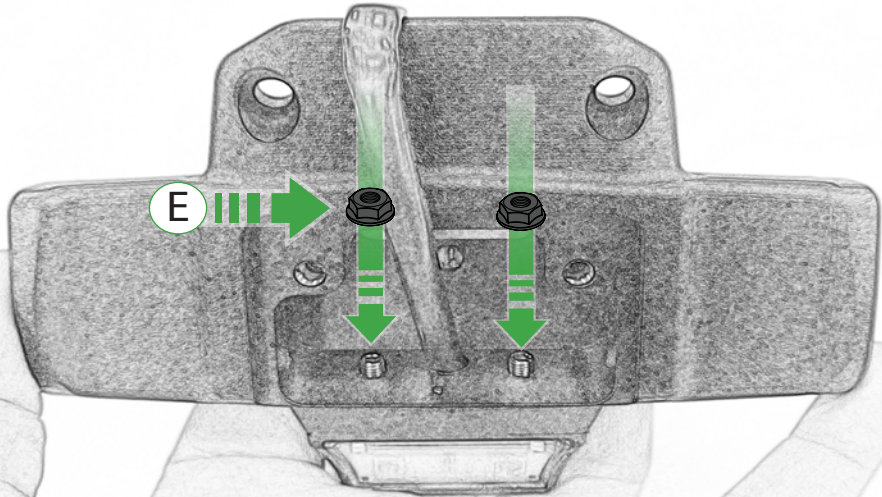

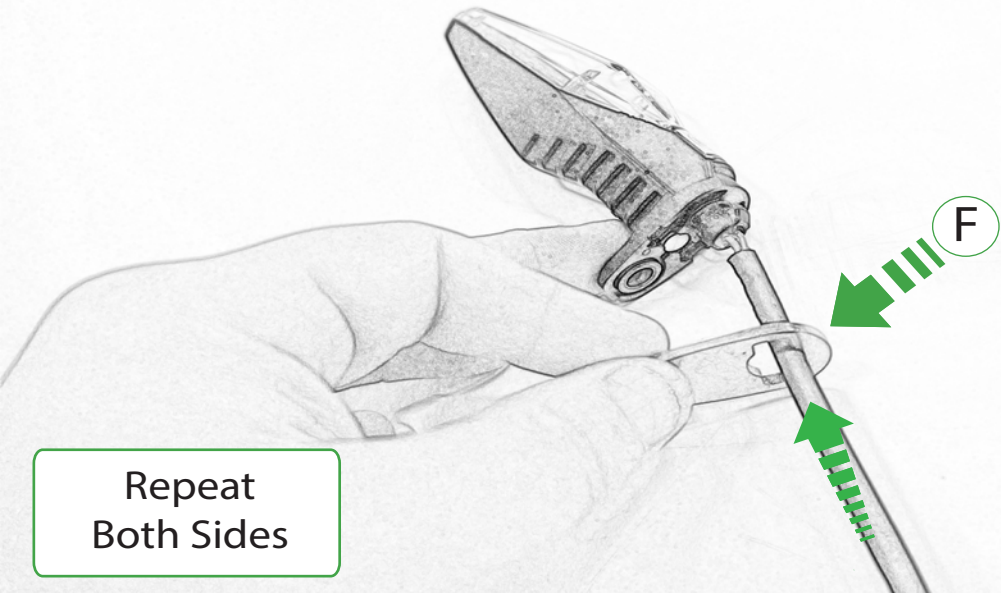

Repeat
Both Sides

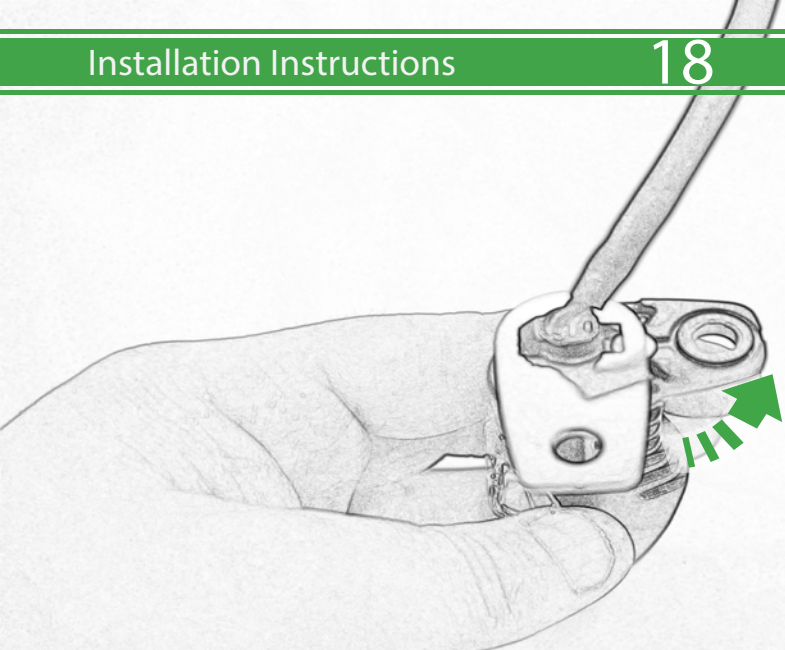

Repeat
Both Sides

Rotate
180°

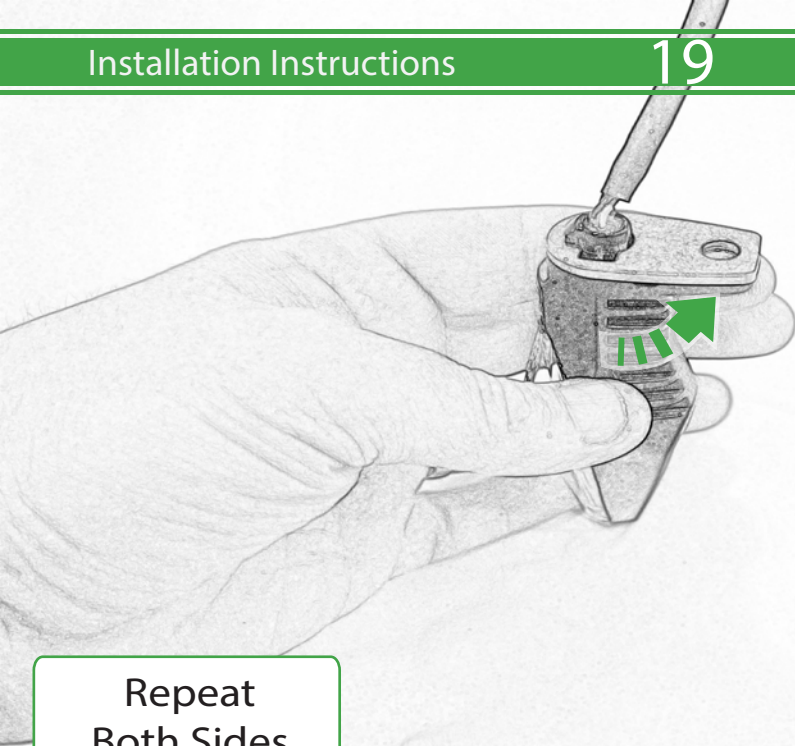

Repeat
Both Sides

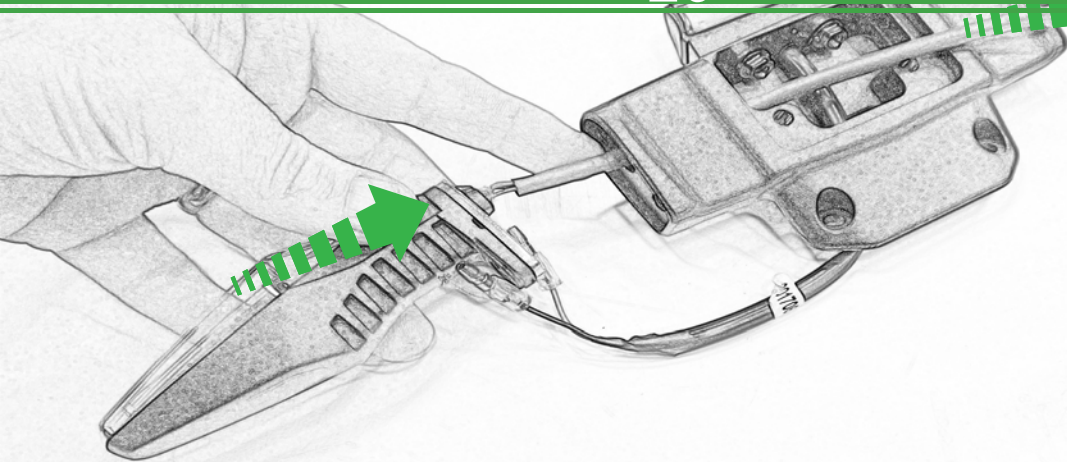

Repeat
Both Sides

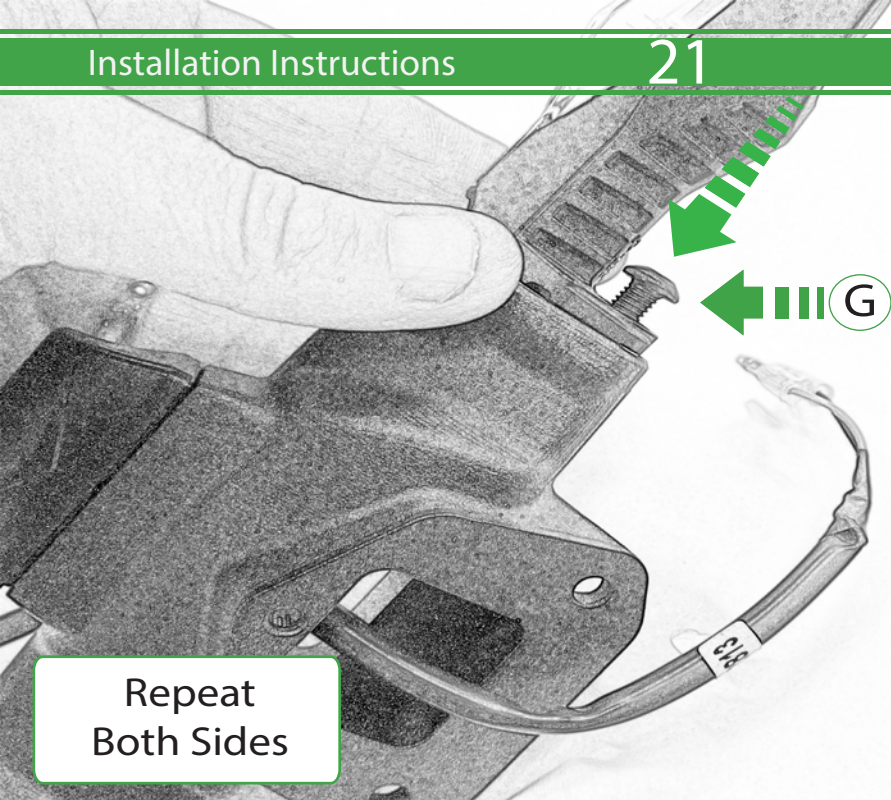

Repeat
Both Sides

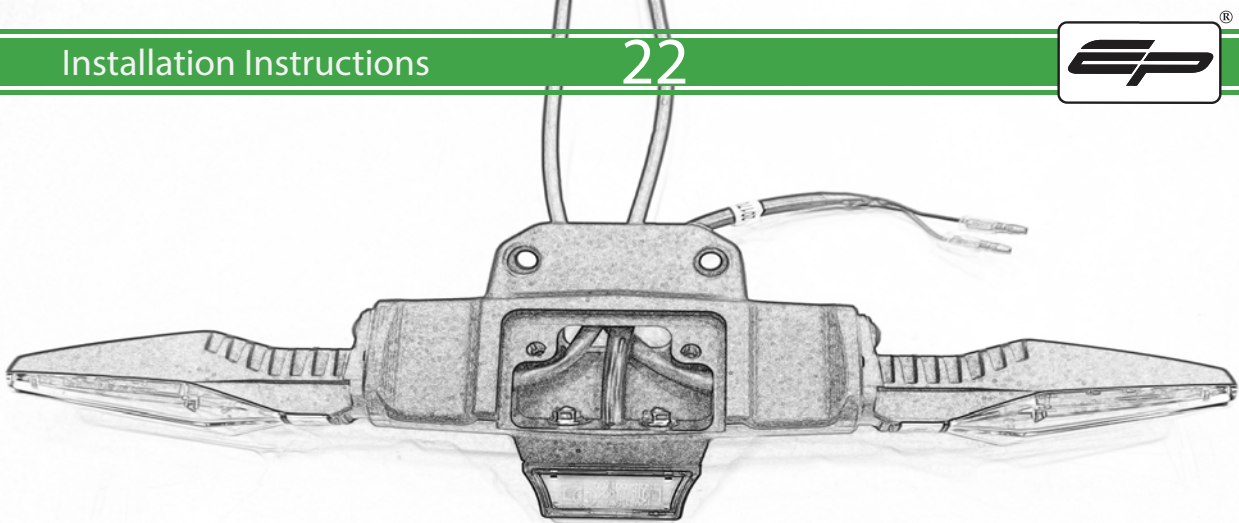

Caution

Run wires neatly down the channel in both parts ensuring they do not get trapped or squashed

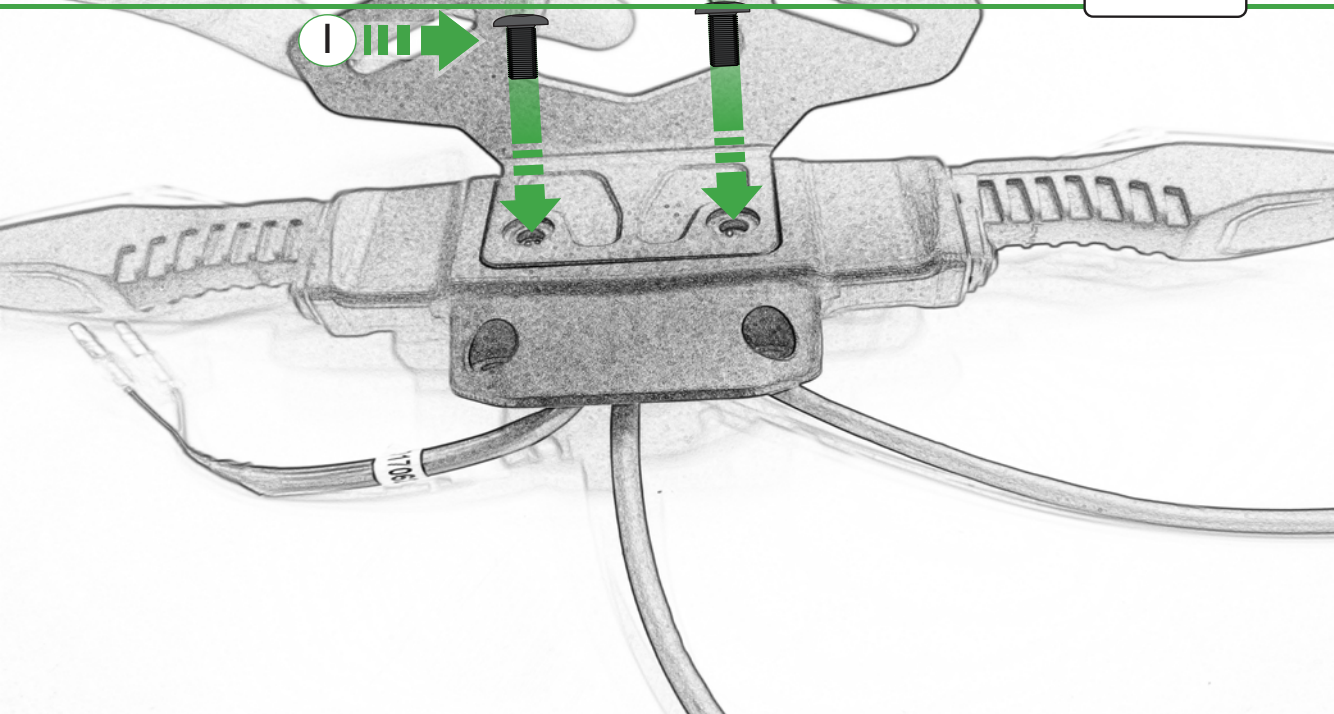

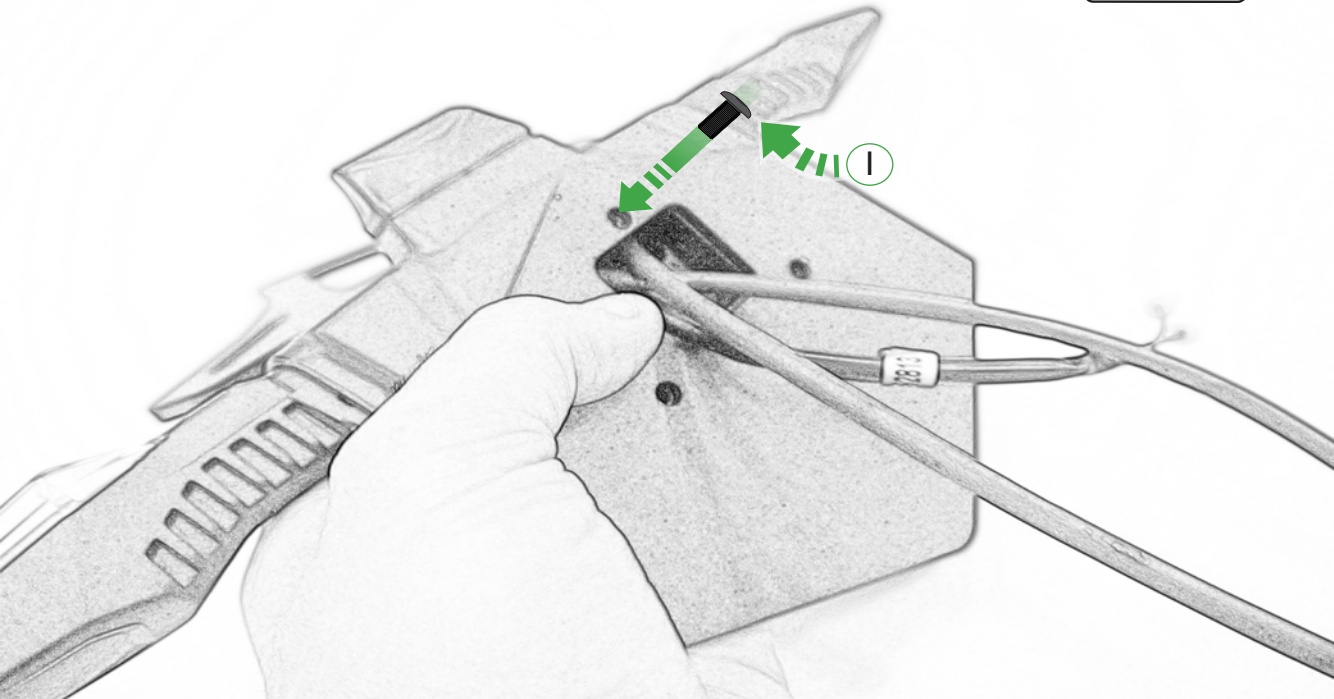

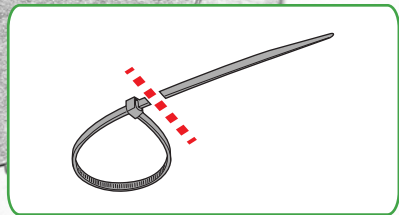
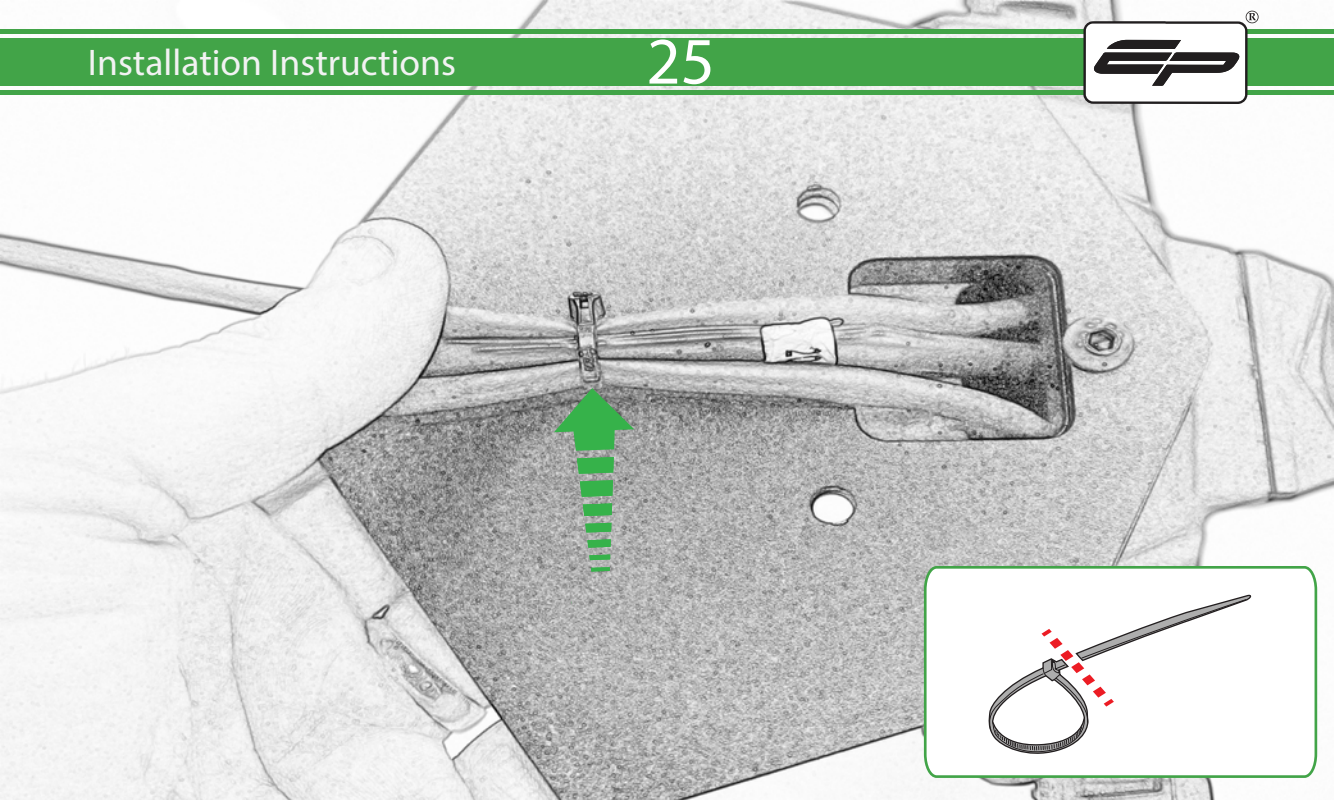

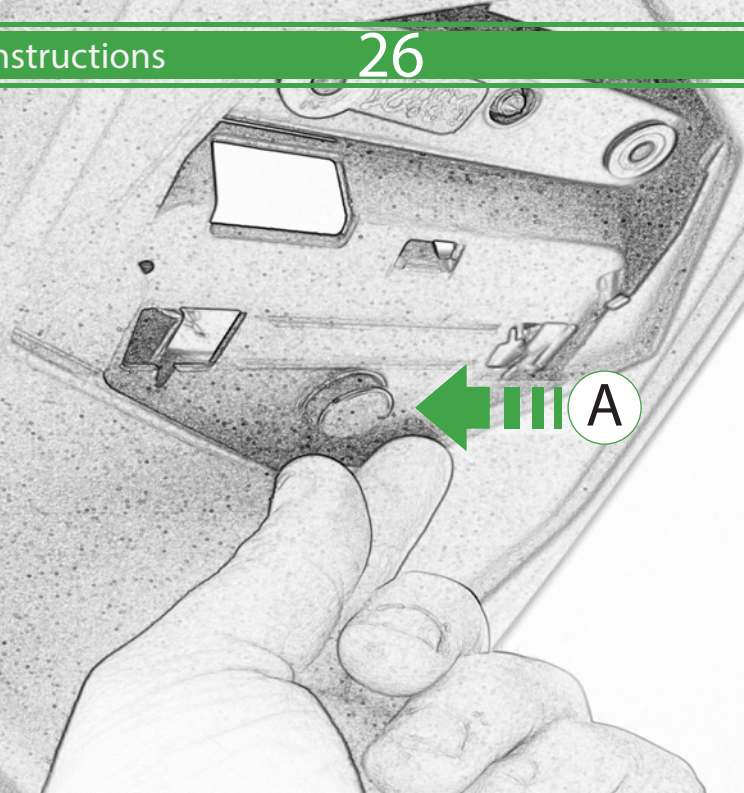



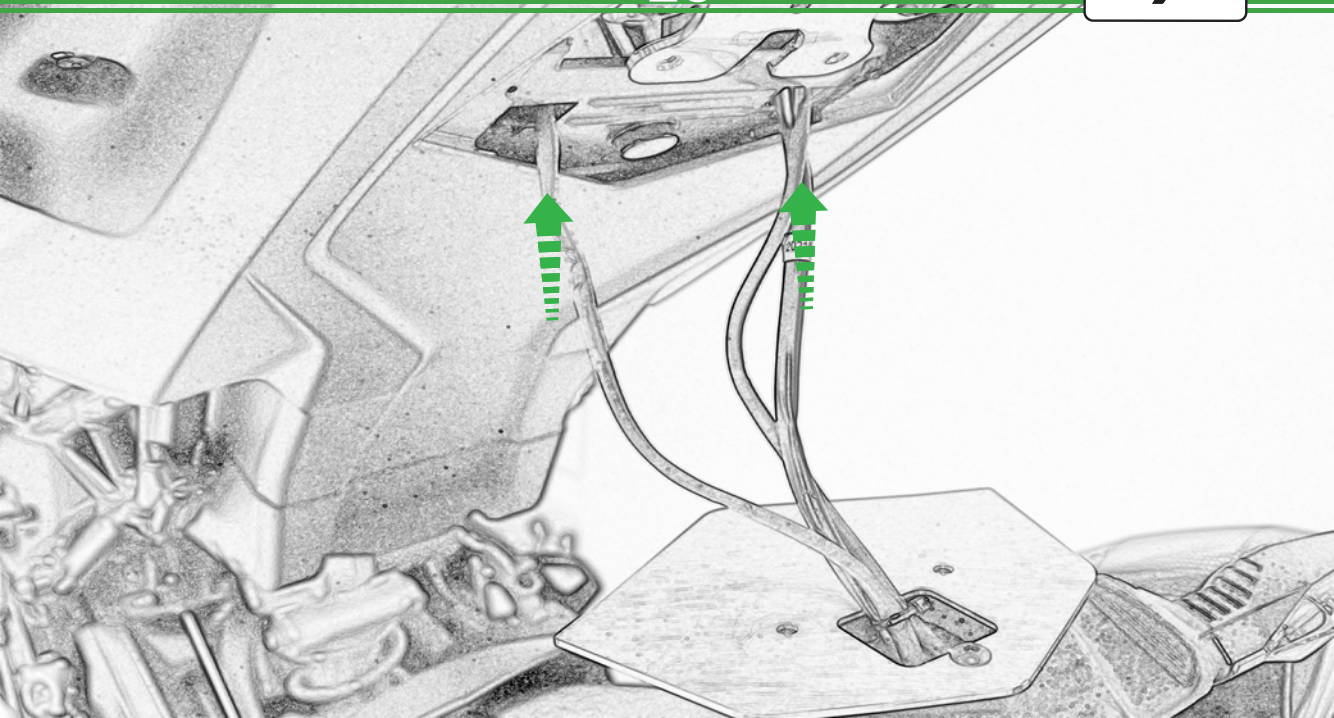

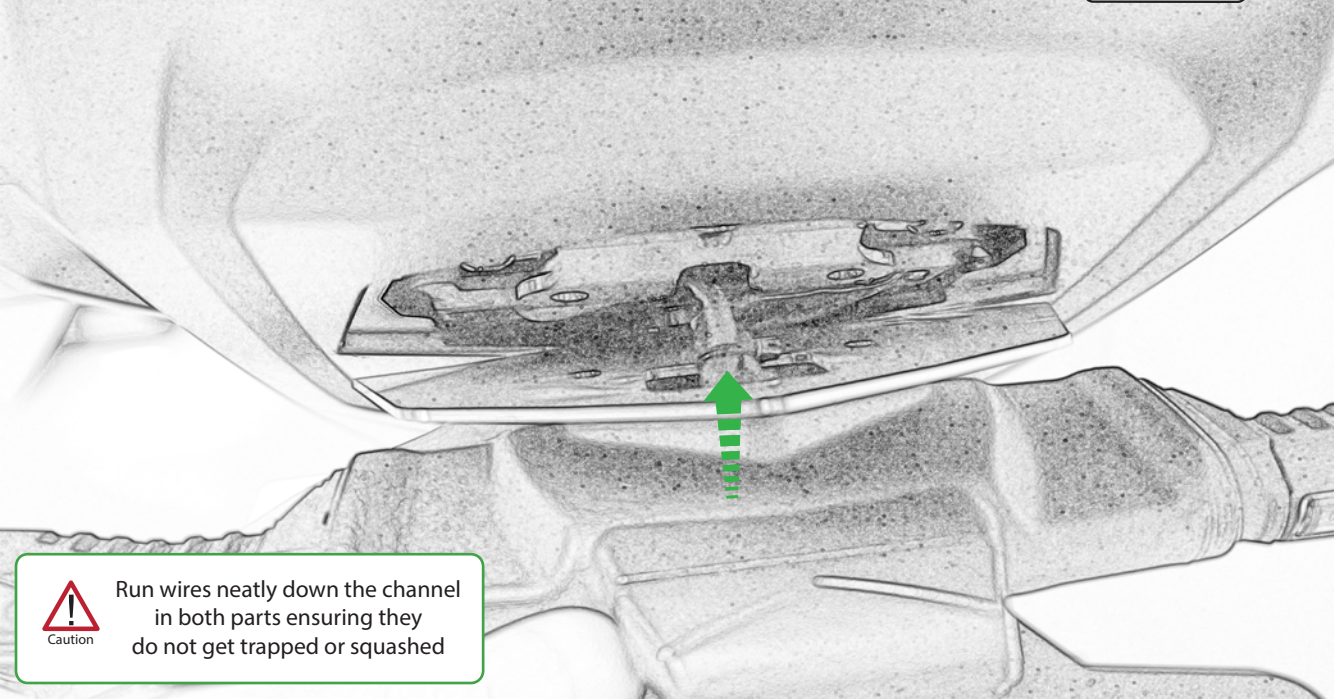

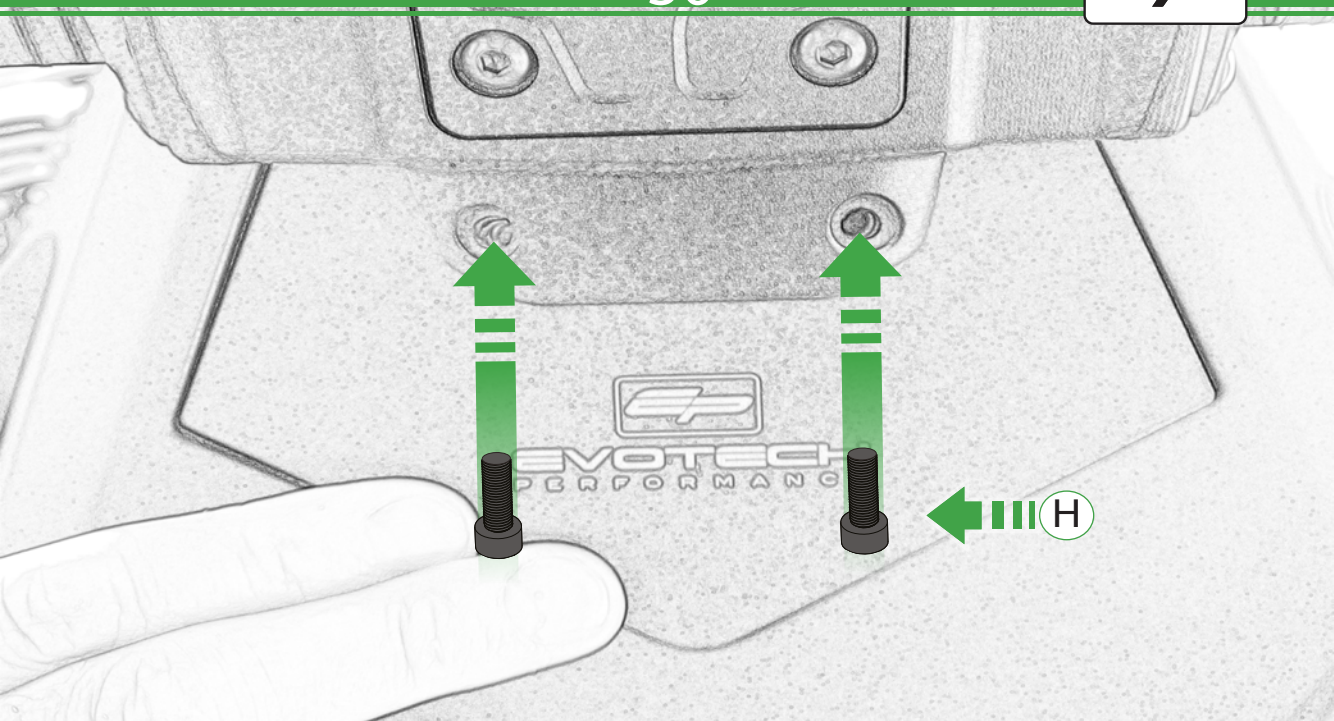

Caution

Run wires neatly down the channel in both parts ensuring they do not get trapped or squashed

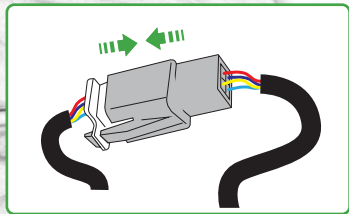
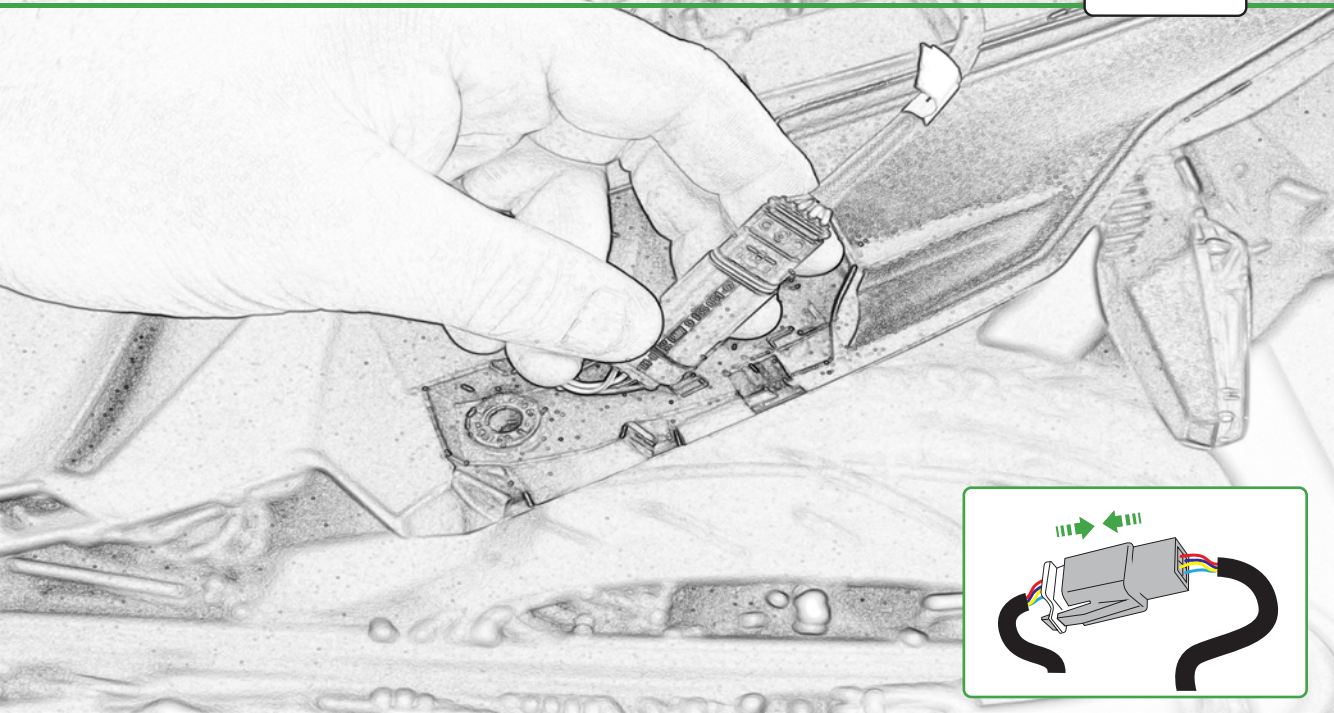

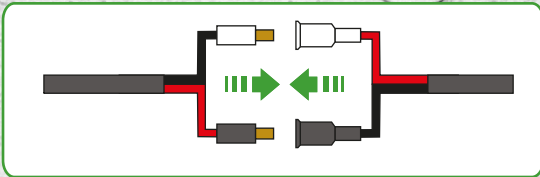
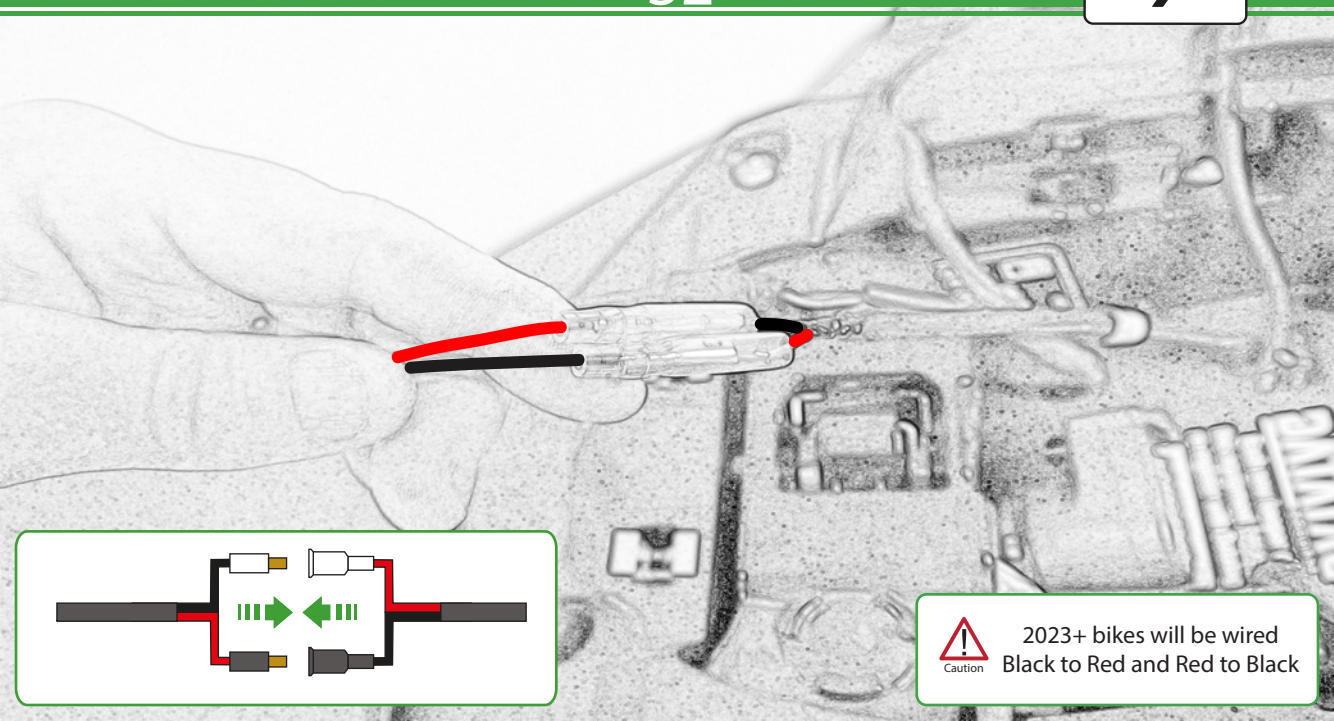



 2023+ bikes will be wired
Black to Red and Red to Black

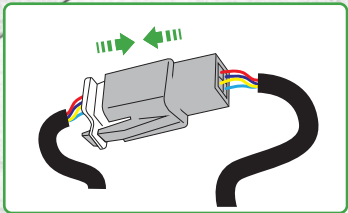
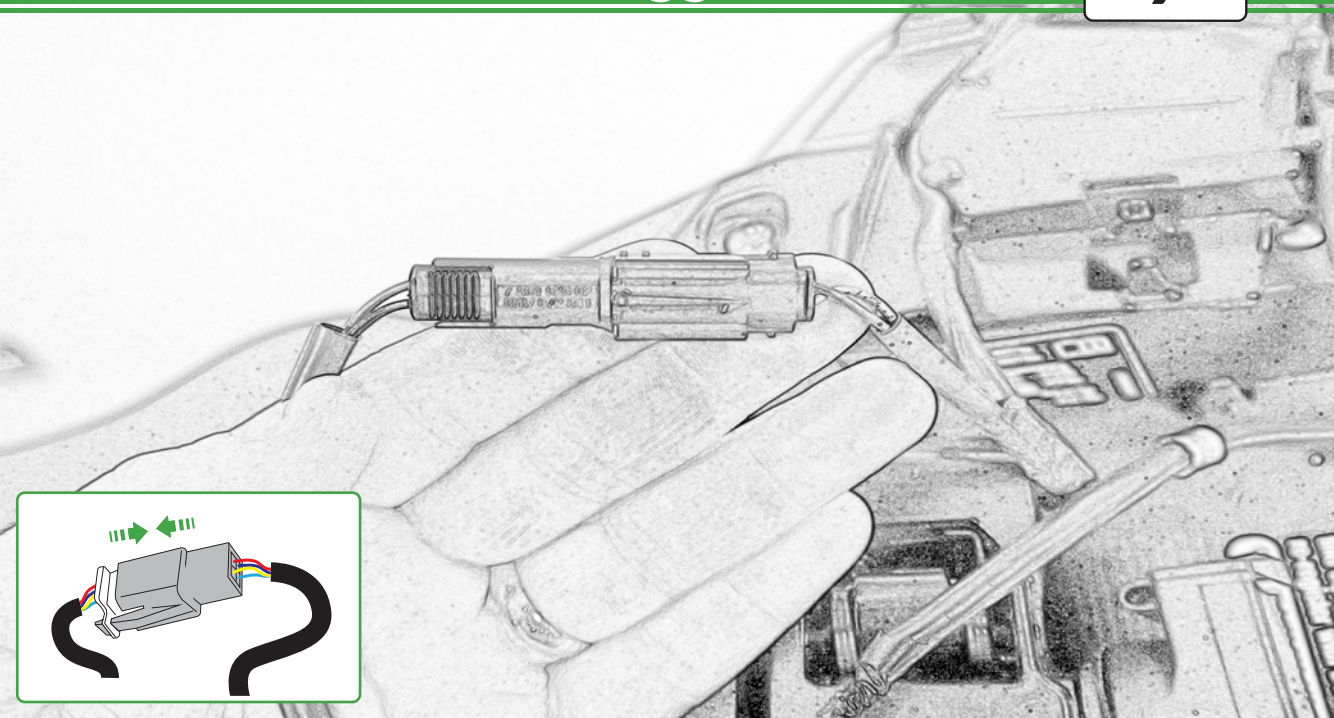



Reverse Stages

4 - 1

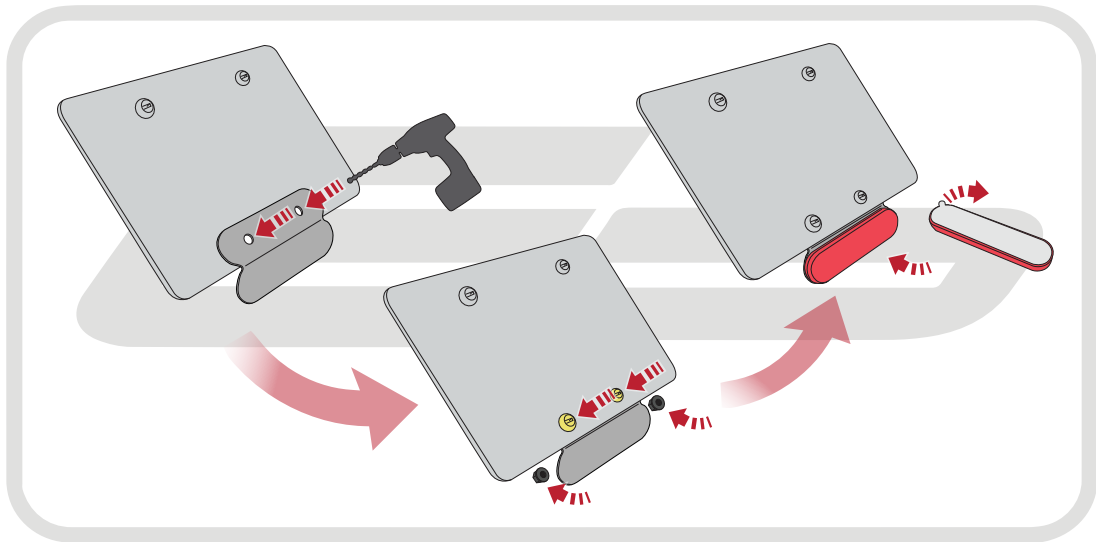

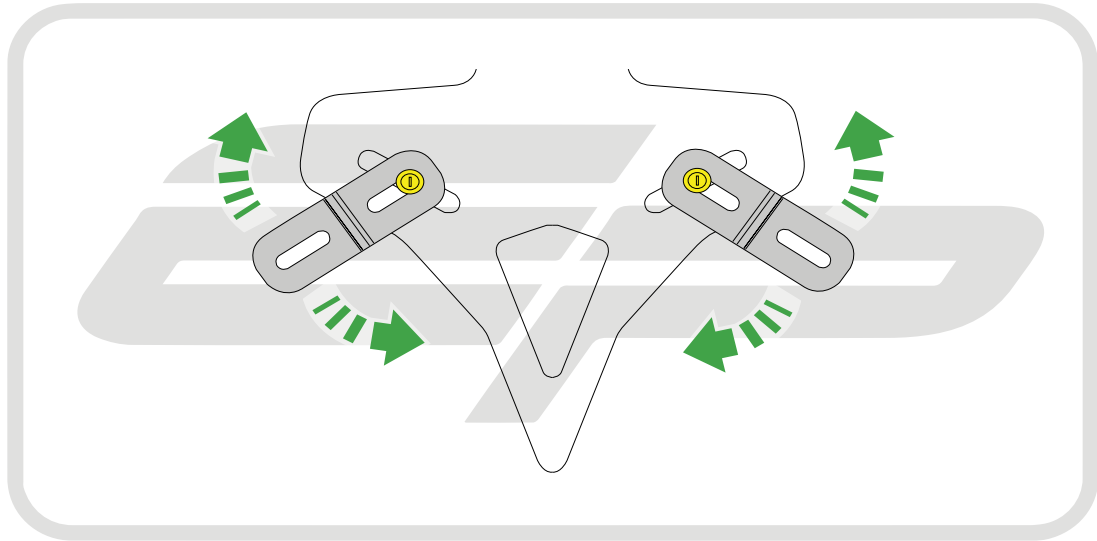



ESSENTIAL CHECKS



After installation of your tail tidy ensure that the licence plate does not contact the rear tyre when suspension is fully compressed.

Ensure all electrics including indicators, tail light, brake light and licence plate light lights are working correctly before riding the motorcycle.

It is recommended that periodic inspections are made to ensure that all fixings are fully tightend.

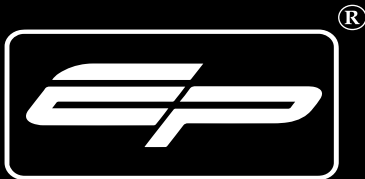

EVOTECH®
P E R F O R M A N C E

www.evotech-performance.com