



EVOTECH®
P E R F O R M A N C E

www.evotech-performance.com

Ducati DesertX Garmin

Sat Nav Mount



Kit Contents

- | | |
|--|---|
| (A) 1 x Main Plate | (L) 2 x M4 x 5mm Black Button Head Bolts |
| (B) 1 x Pivot Plate | (M) 4 x M4 x 10mm Black Button Head Bolts |
| (C) 1 x Sub Mounting Bracket | |
| (D) 2 x M5 x 8mm Black Button Head Bolts | |
| (E) 2 x P-clips (No.1) | |
| (F) 2 x P-clips (No.2) | Sub Kit |
| (G) 2 x P-clips (No.3) | (AA) 1 x Spacer (Short Spacer) |
| (H) 2 x P-clips (No.4) | (BB) 1 x M6 x 35mm Black Button Head |
| (I) 2 x Lobe Screw | (CC) 2 x Spacer (Long Spacer) |
| (J) 2 x M5 Black Washer | (DD) 2 x M6 x 45mm Black Button Head |
| (K) 2 x Locking Washer | |



Repeat
Both Sides

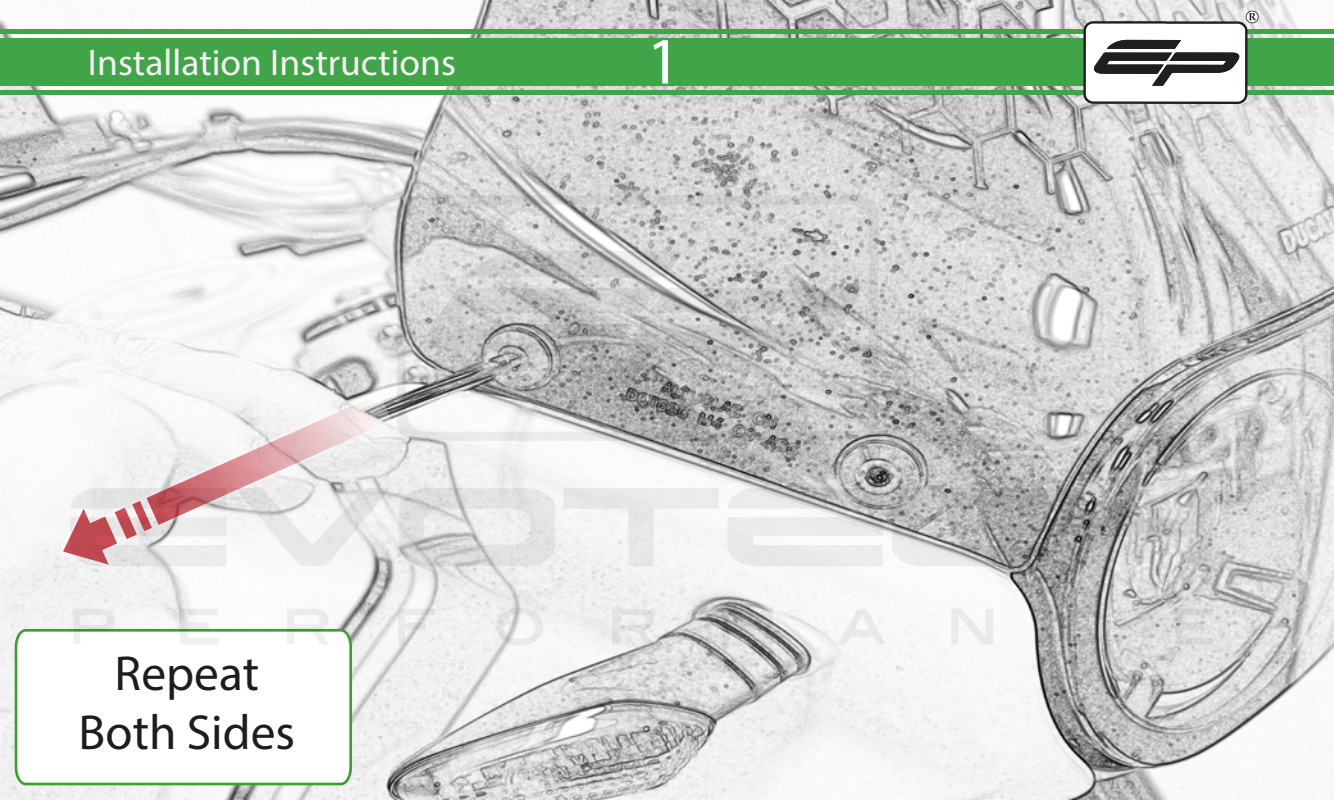

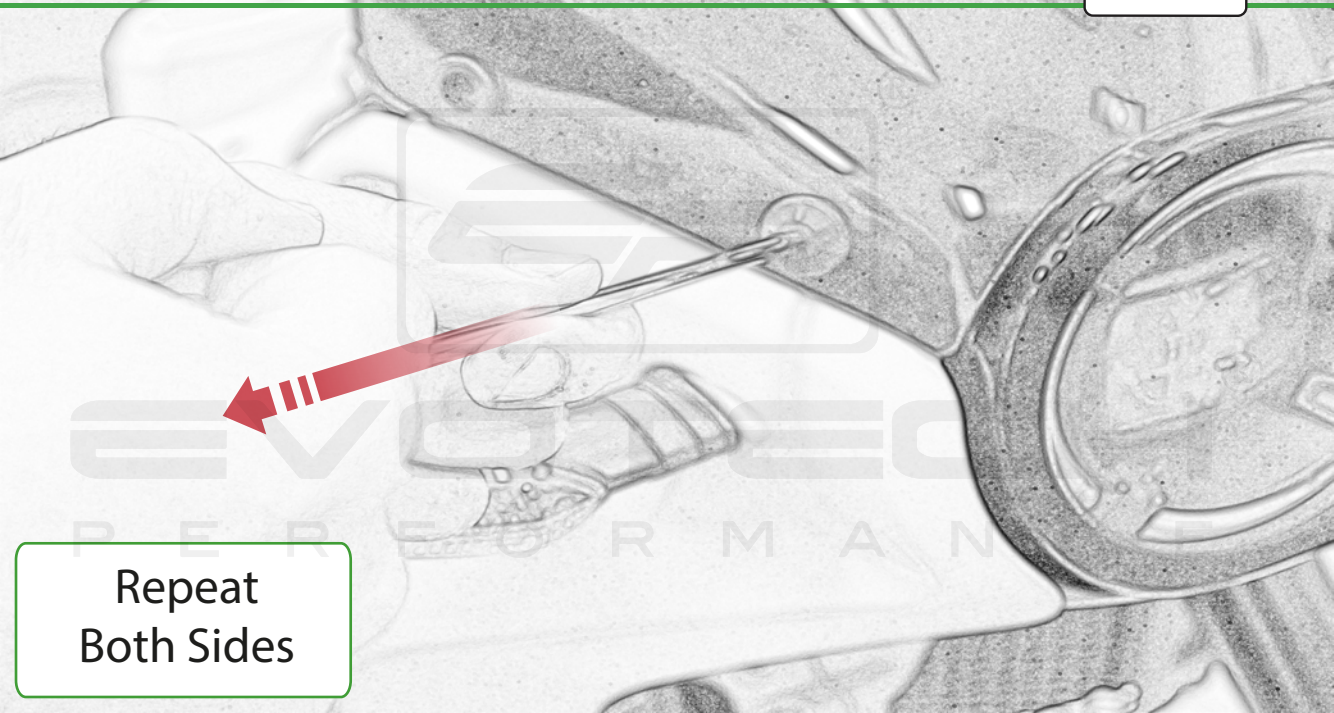

Repeat
Both Sides

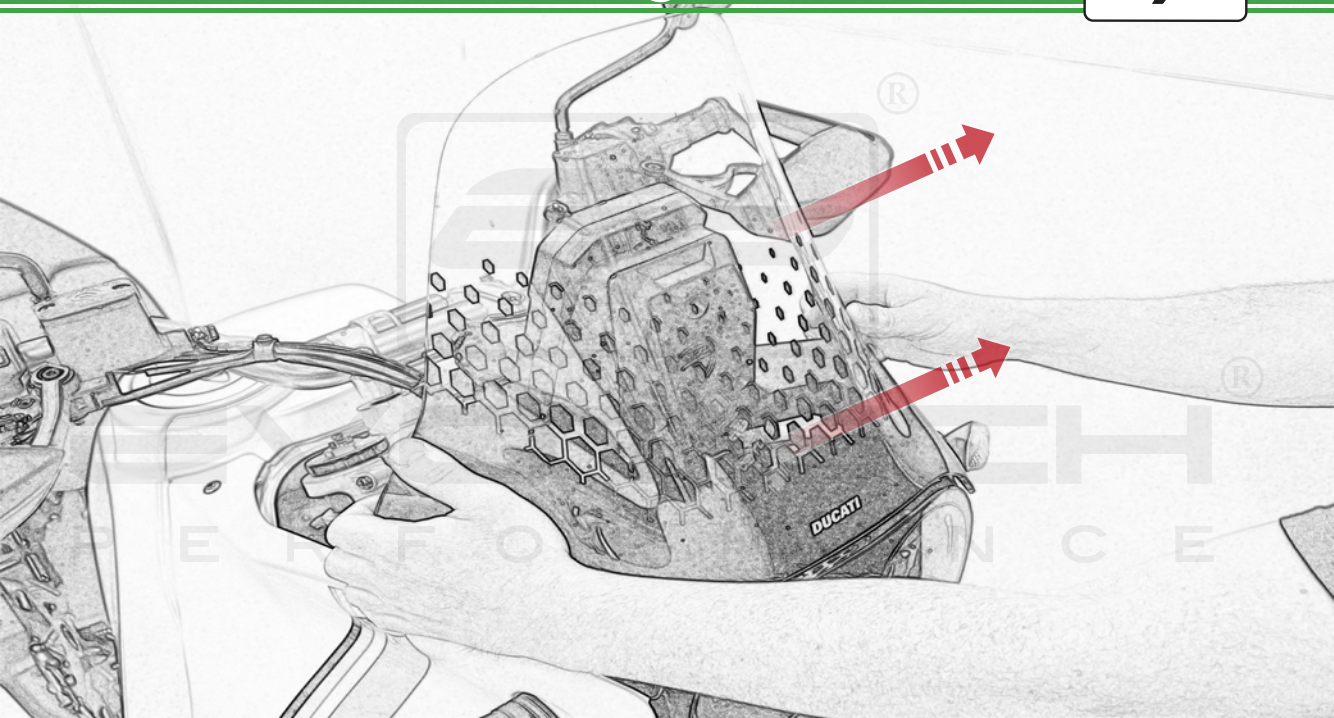

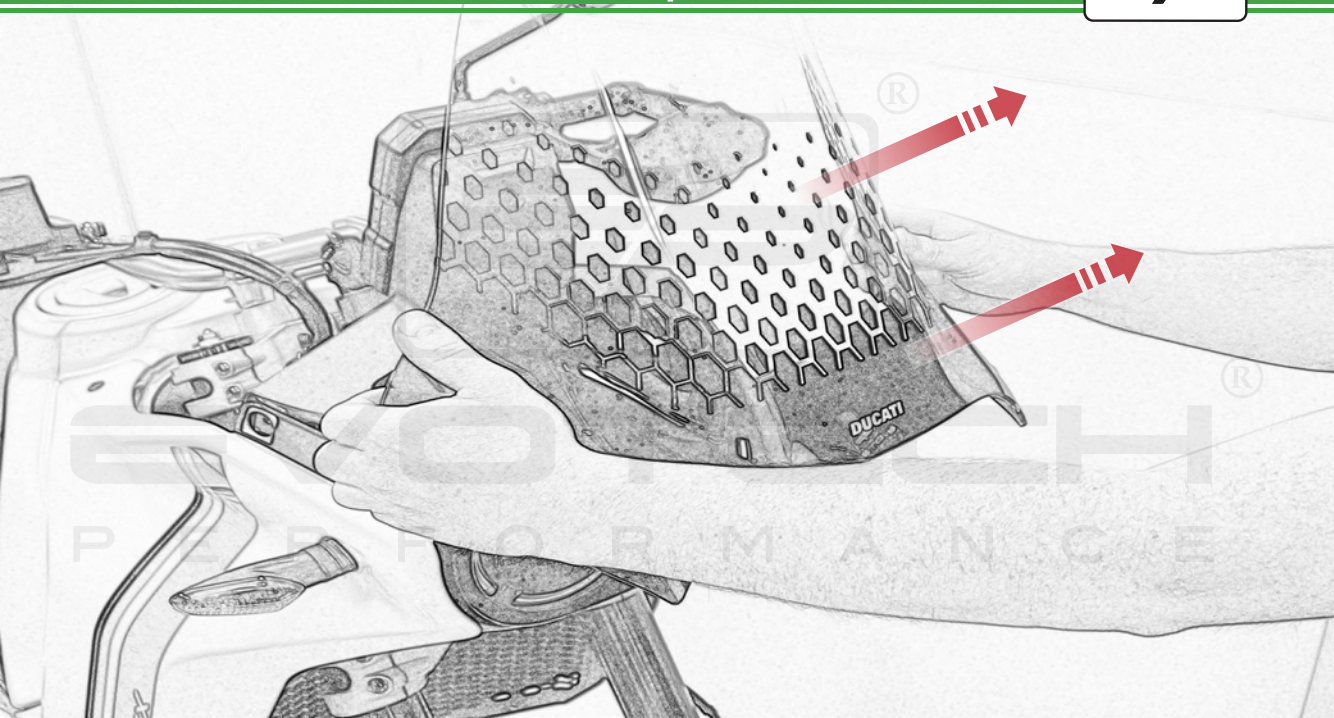

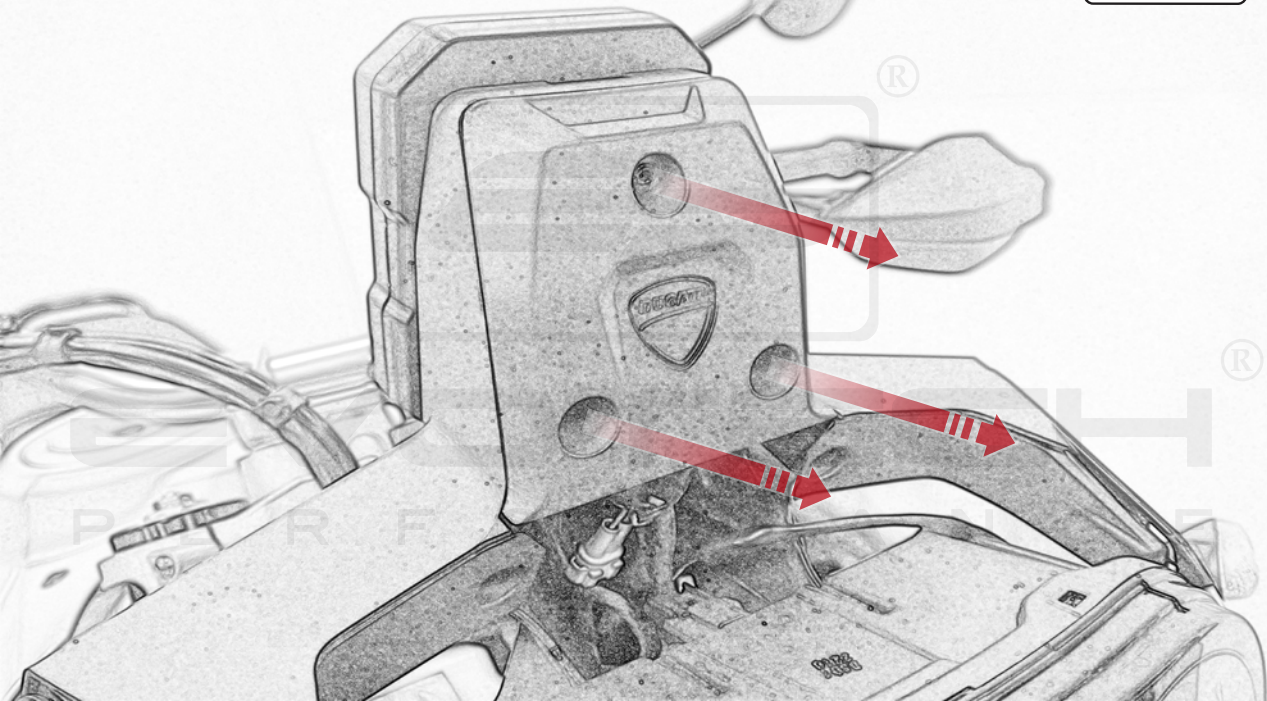



This is optional

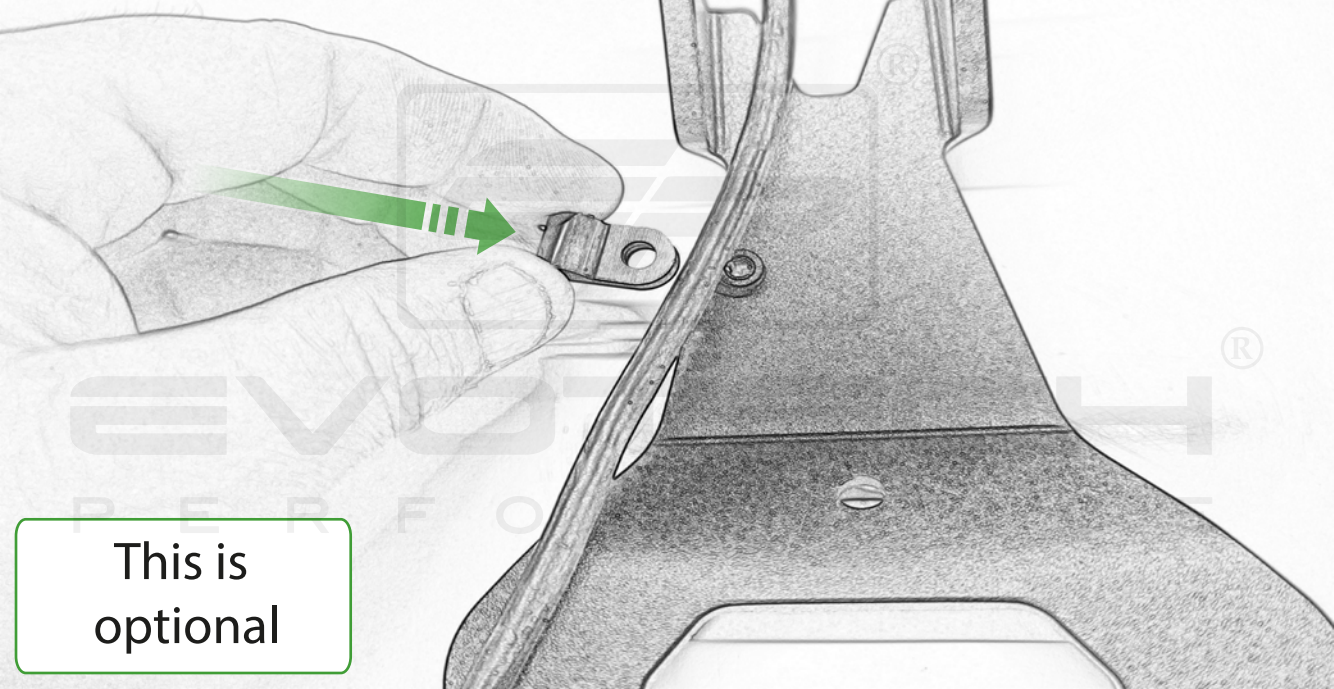

This is optional



M

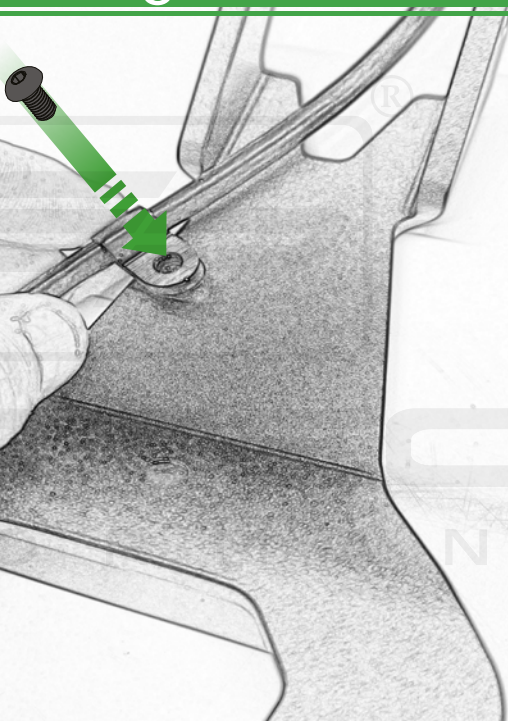

This is optional

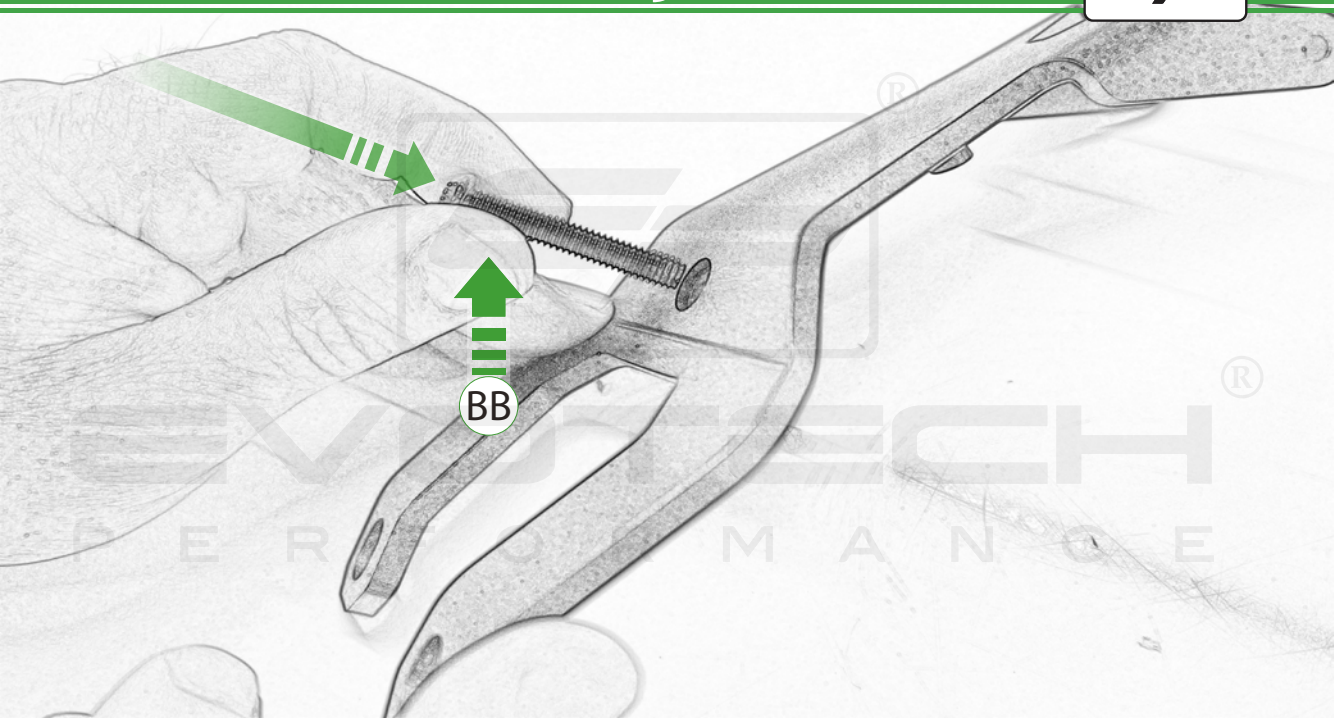

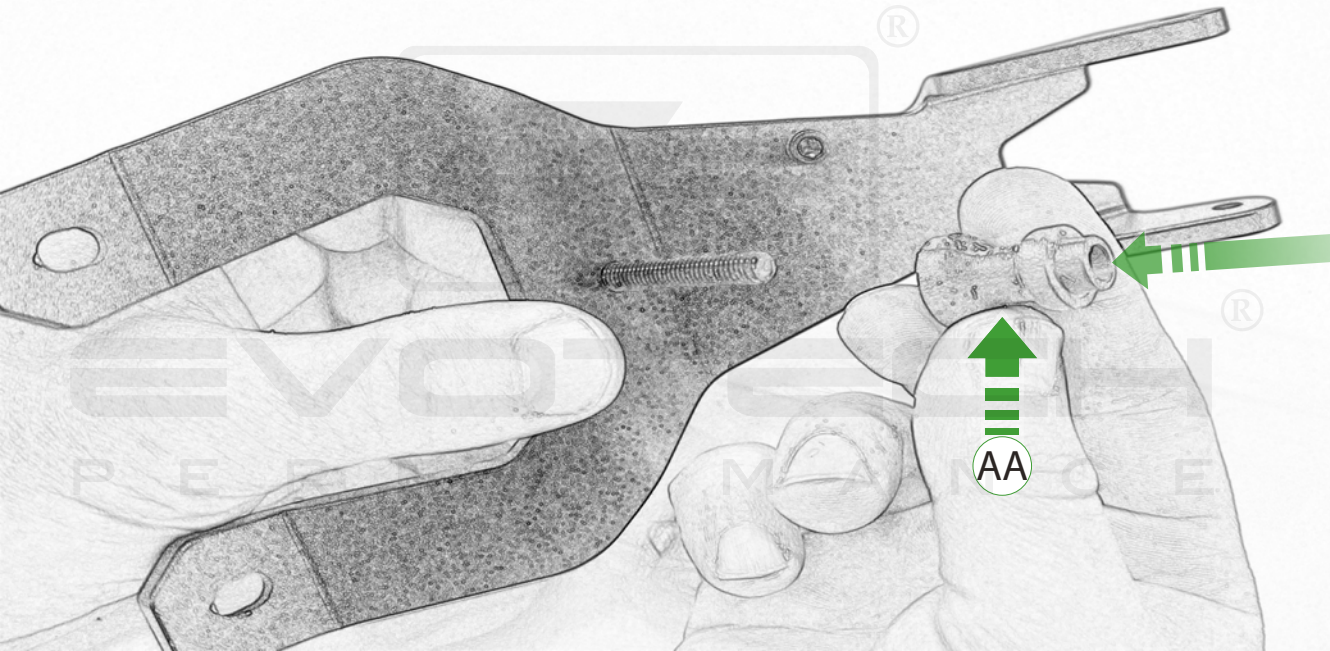

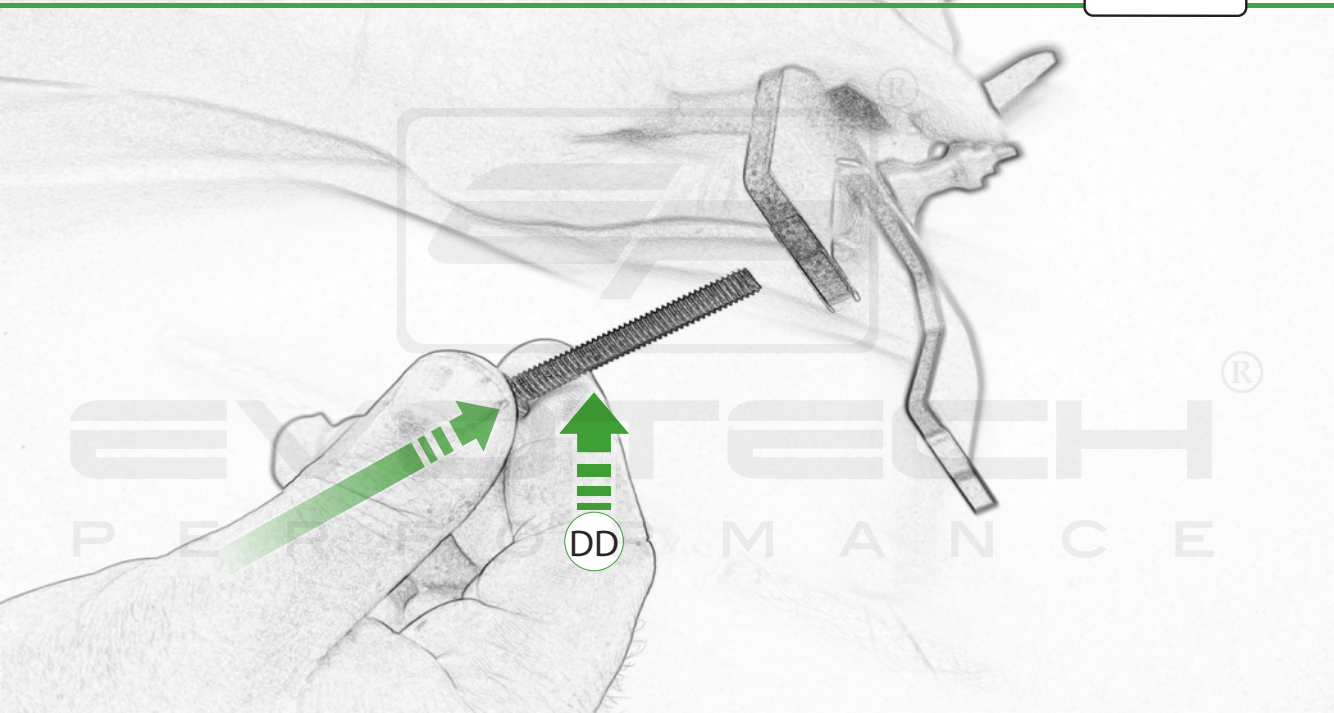

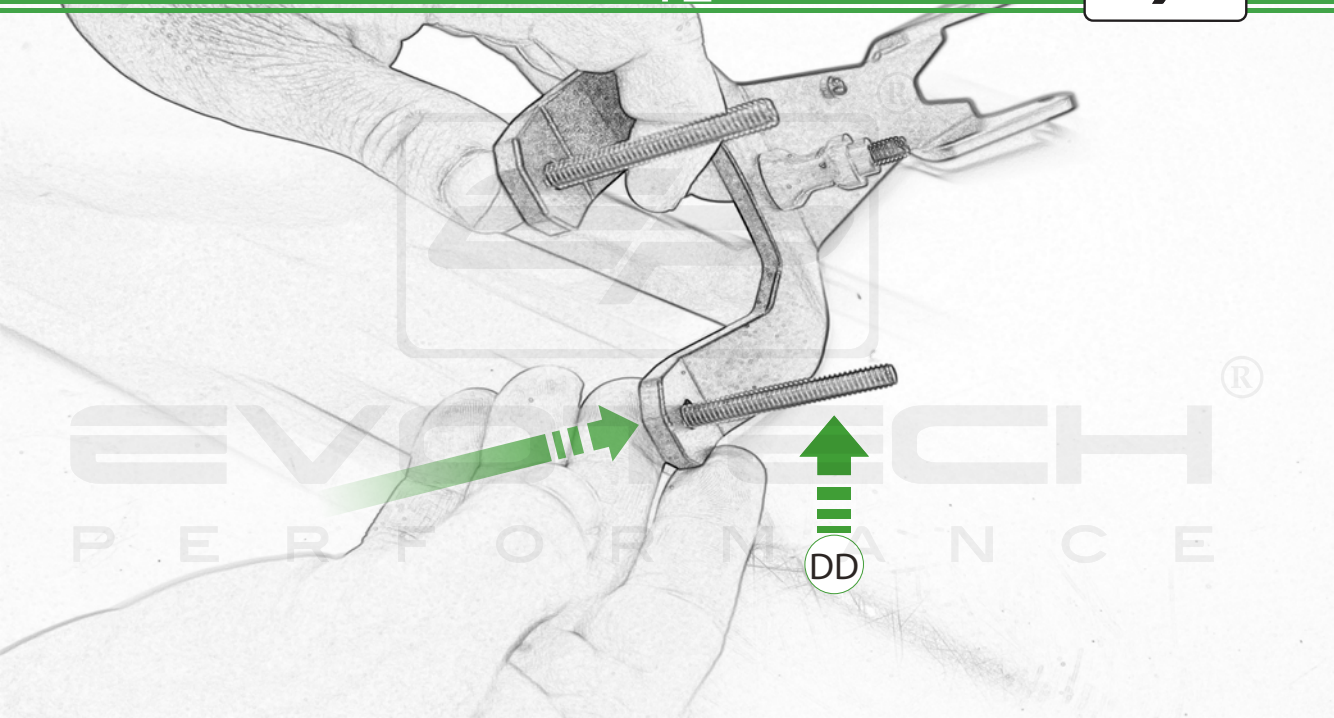

DD

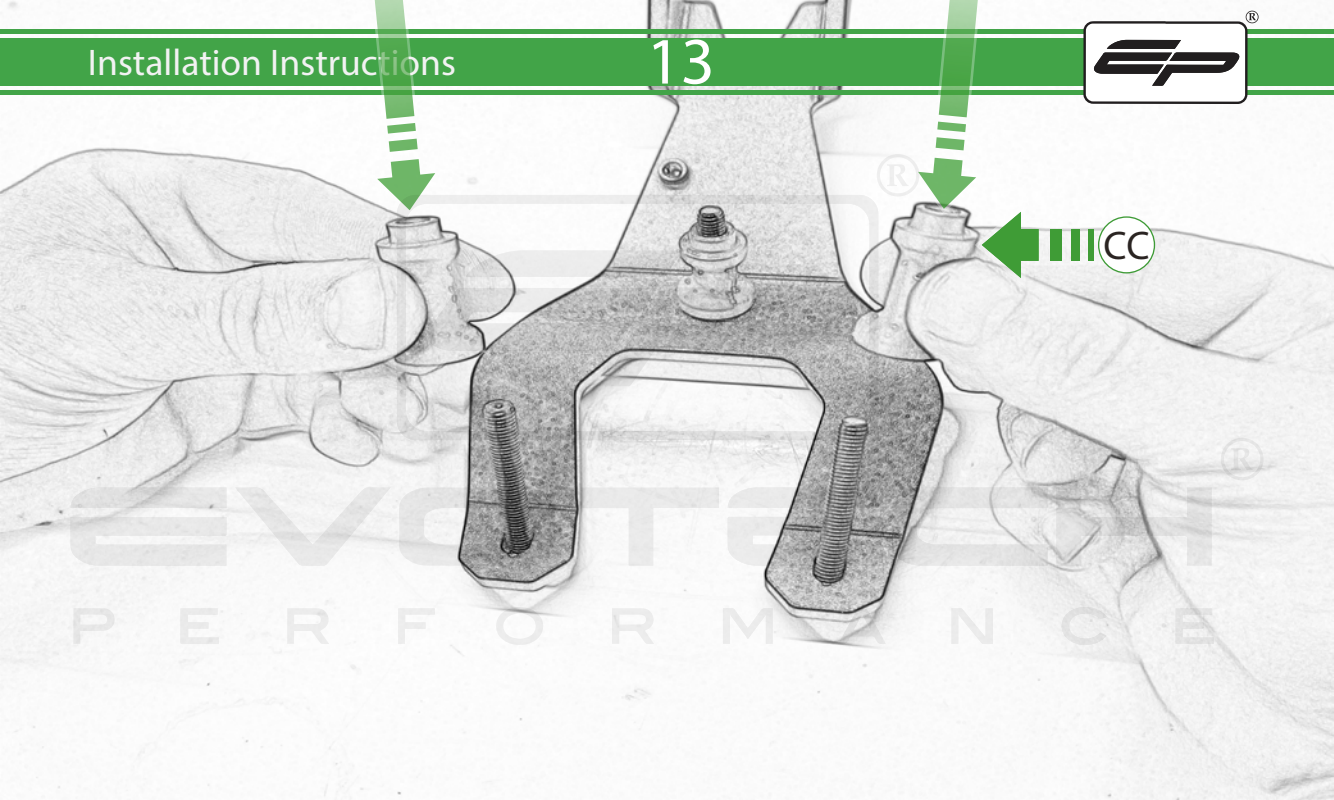

EVEREADY

PERFORMANCE

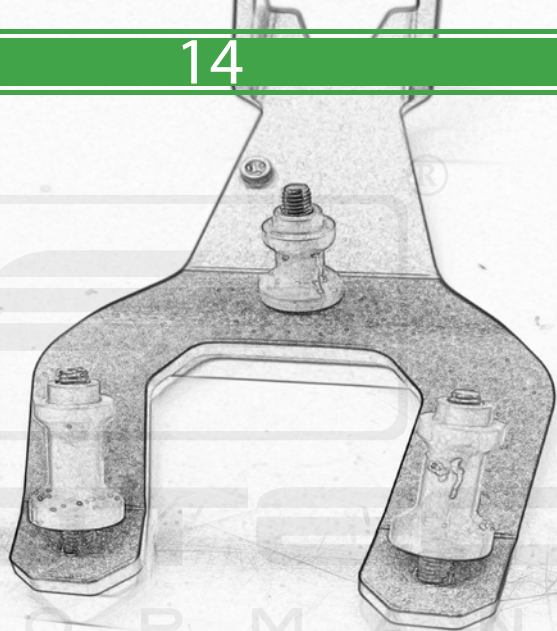

EVEREADY[®]
PERFORMANCE



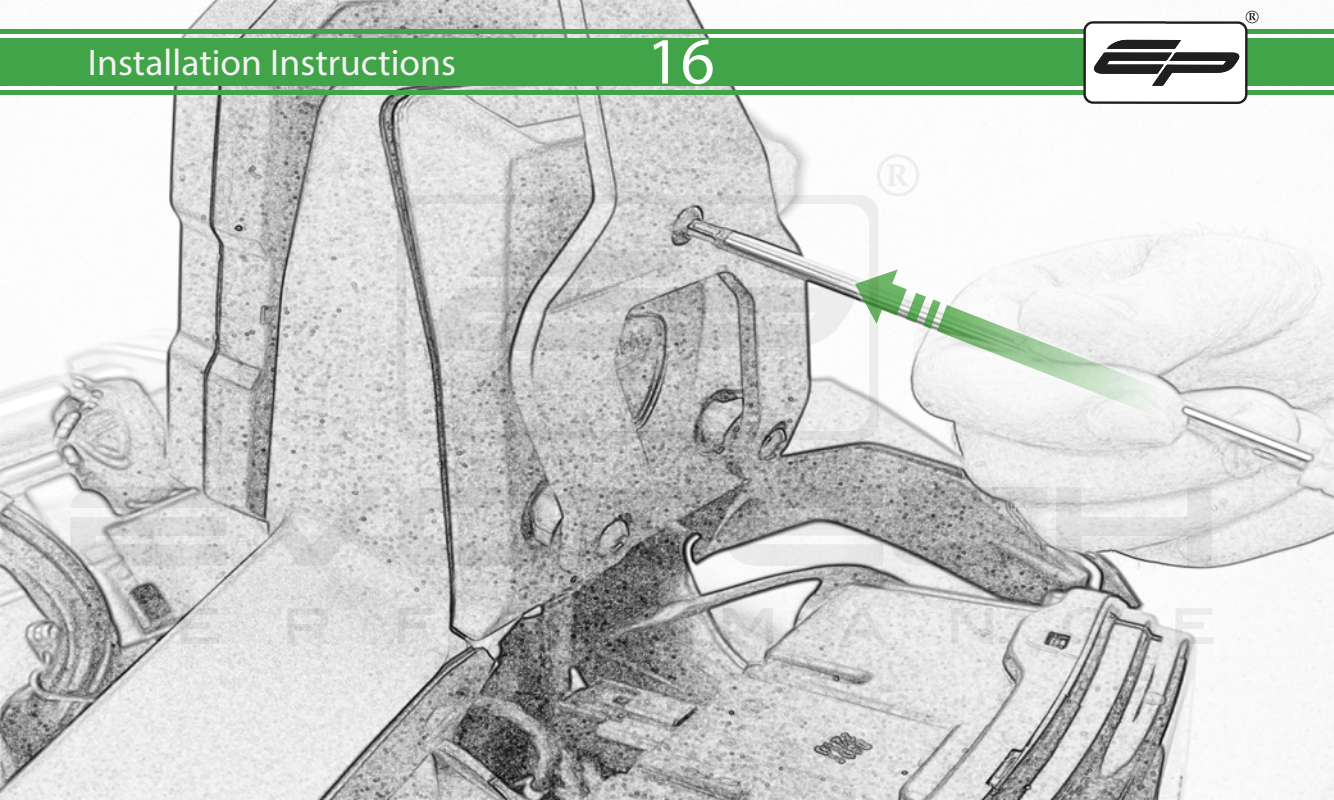

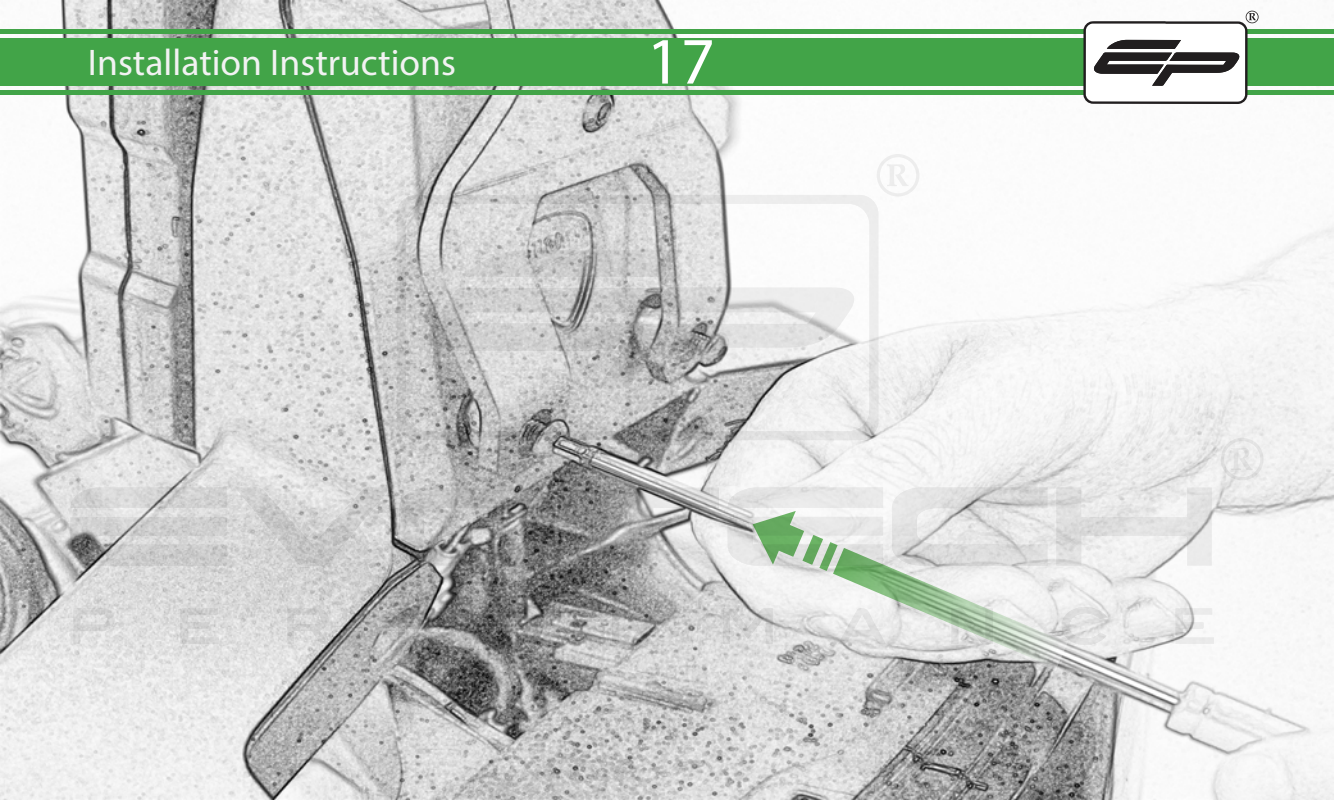

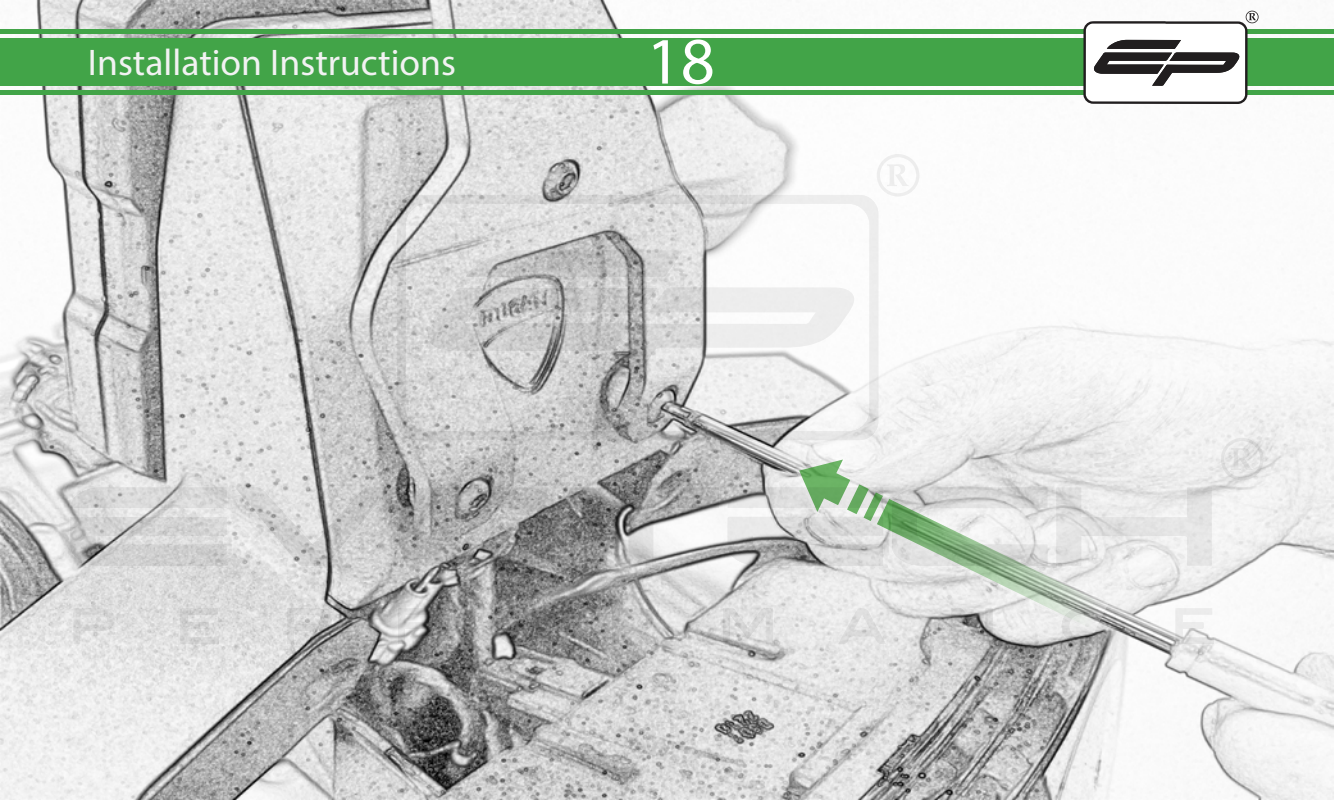

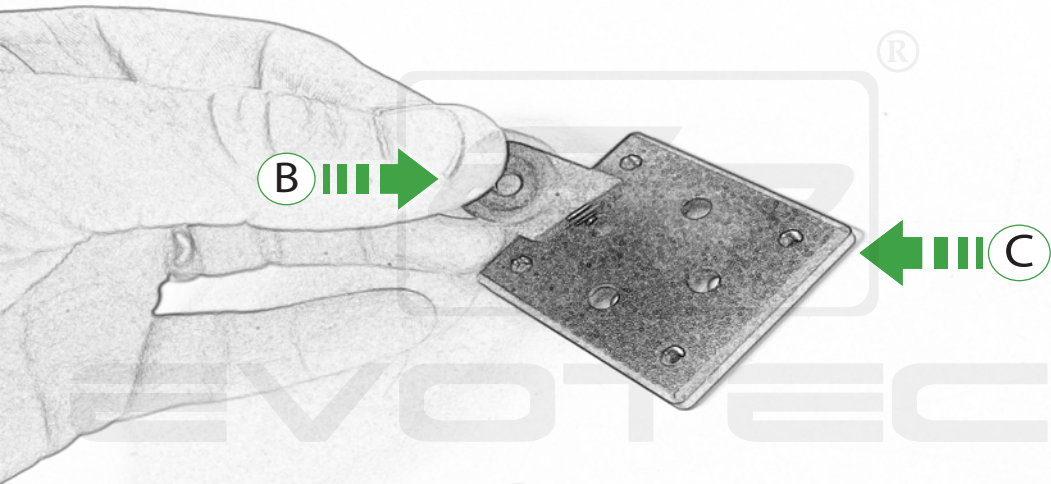

B

C

PERFORMANCE

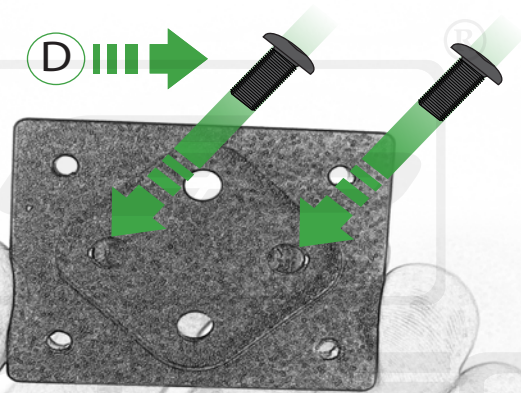

EVOLVING TECHNOLOGY[®]
PERFORMANCE



EVERTECH[®]
P E R F O R M A N C E[®]

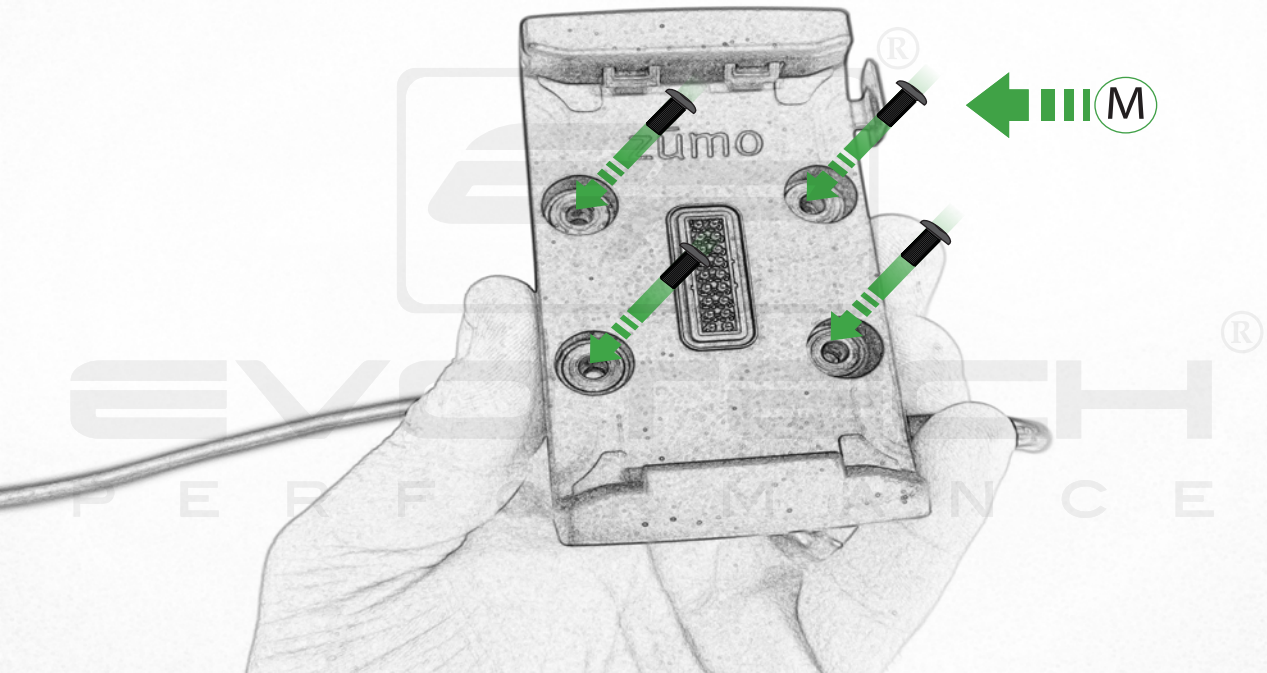





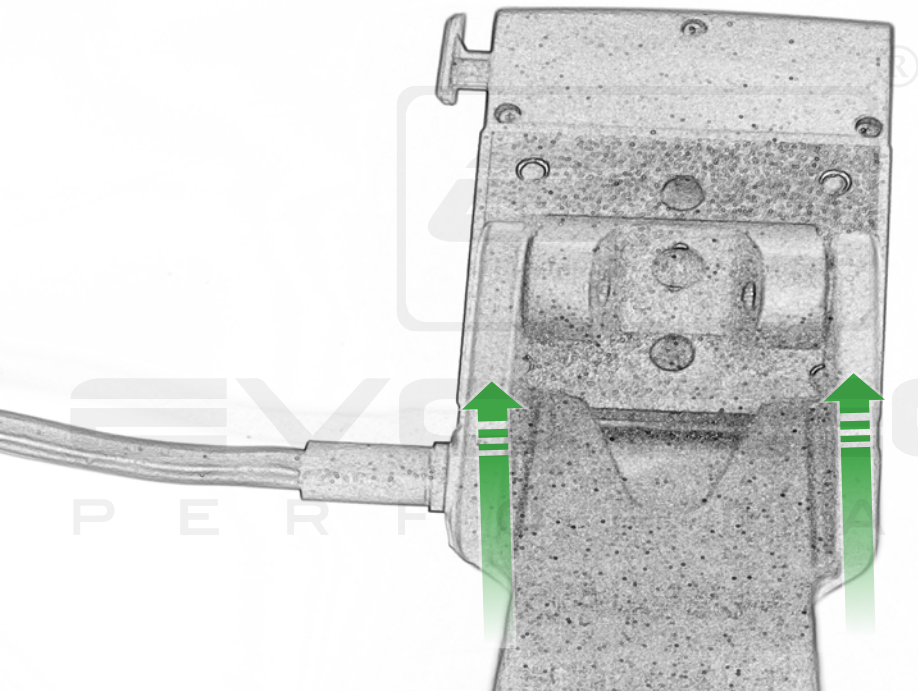

EVOLVING PERFORMANCE

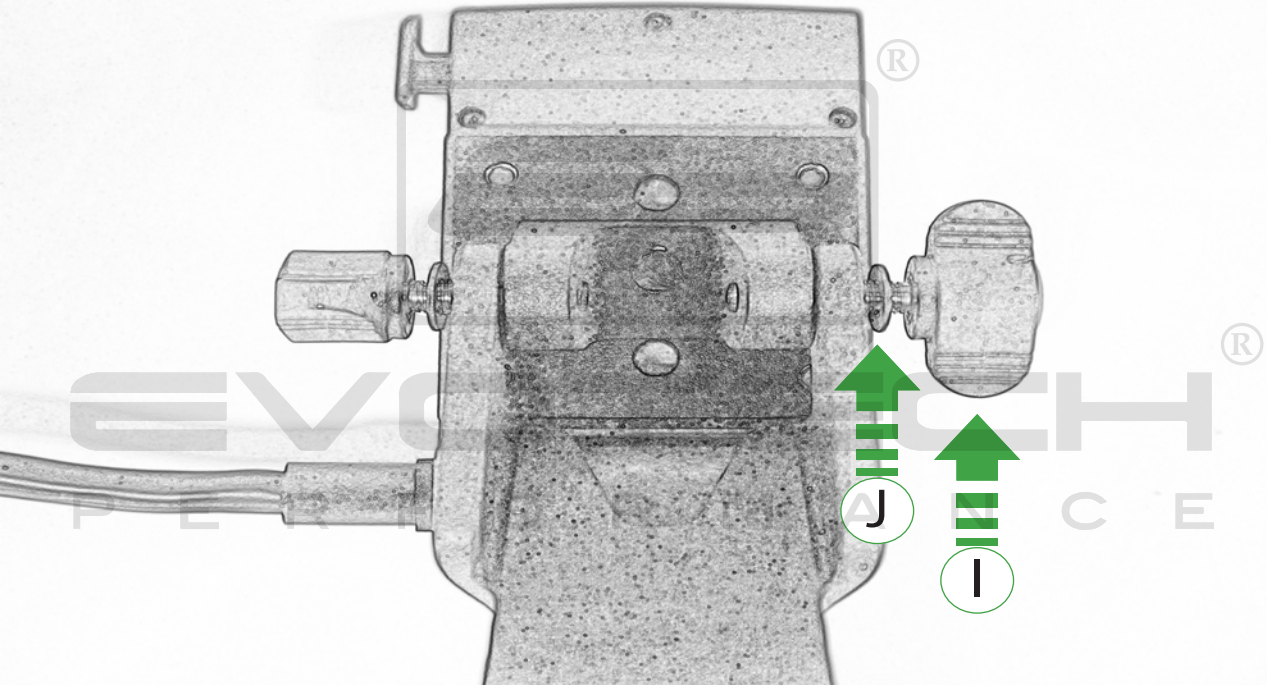



ESSENTIAL CHECKS

It is recommended that periodic inspections are made to ensure that all bolts are tightened to the specified torque settings.

Should the bike be involved in an accident a thorough inspection should be made and any components that have taken an impact, no matter how small, be replaced

P E R F O R M A N C E



EVOTECH®
P E R F O R M A N C E

www.evotech-performance.com