



EVOTECH®
P E R F O R M A N C E

www.evotech-performance.com

Ducati Streetfighter V4 / Panigale V4
Tail Tidy Instructions



Kit Contents PRN014957

- Ⓐ 1 x Reflector Kit
- Ⓑ 1 x Support Arm
- Ⓒ 1 x Connector Type 10
- Ⓓ 1 x EP Number Plate Light
- Ⓔ 1 x M4 x 10 Button Head Bolt
- Ⓕ 1 x M5 x 8 Button Head Bolt
- Ⓖ 2 x M4 Nuts
- Ⓗ 2 x Indicator Adaptors
- Ⓘ 2 x M6 x 12 Button Head Bolt
- Ⓝ 2 x M5 x 16 Button Head Bolt
- Ⓚ 2 x M5 x 70 Button Head Bolts (Double Stem Version)
- Ⓛ 2 x M5 x 40 Button Head Bolts (Single Stem Version)
- Ⓜ 2 x M5 x 12 Button Head Bolt
- Ⓝ 4 x Indicator Stems
- Ⓞ 4 x Indicator Clamps

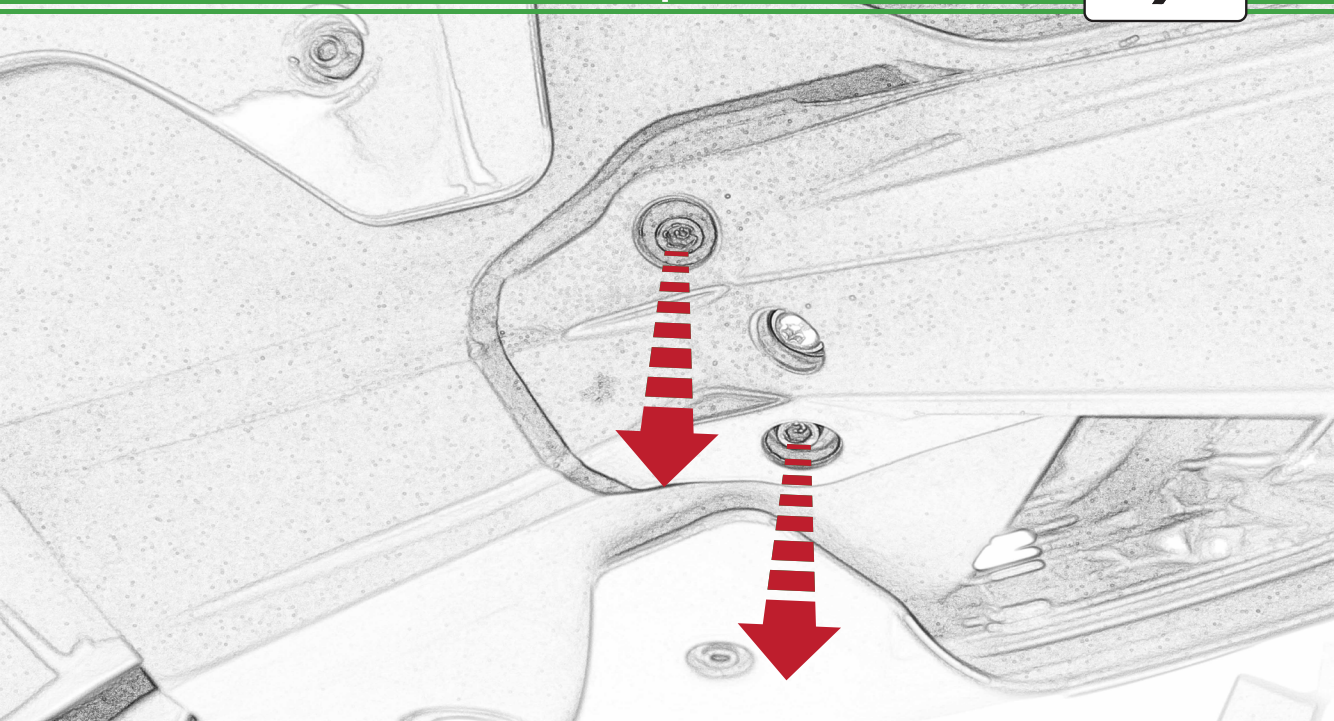

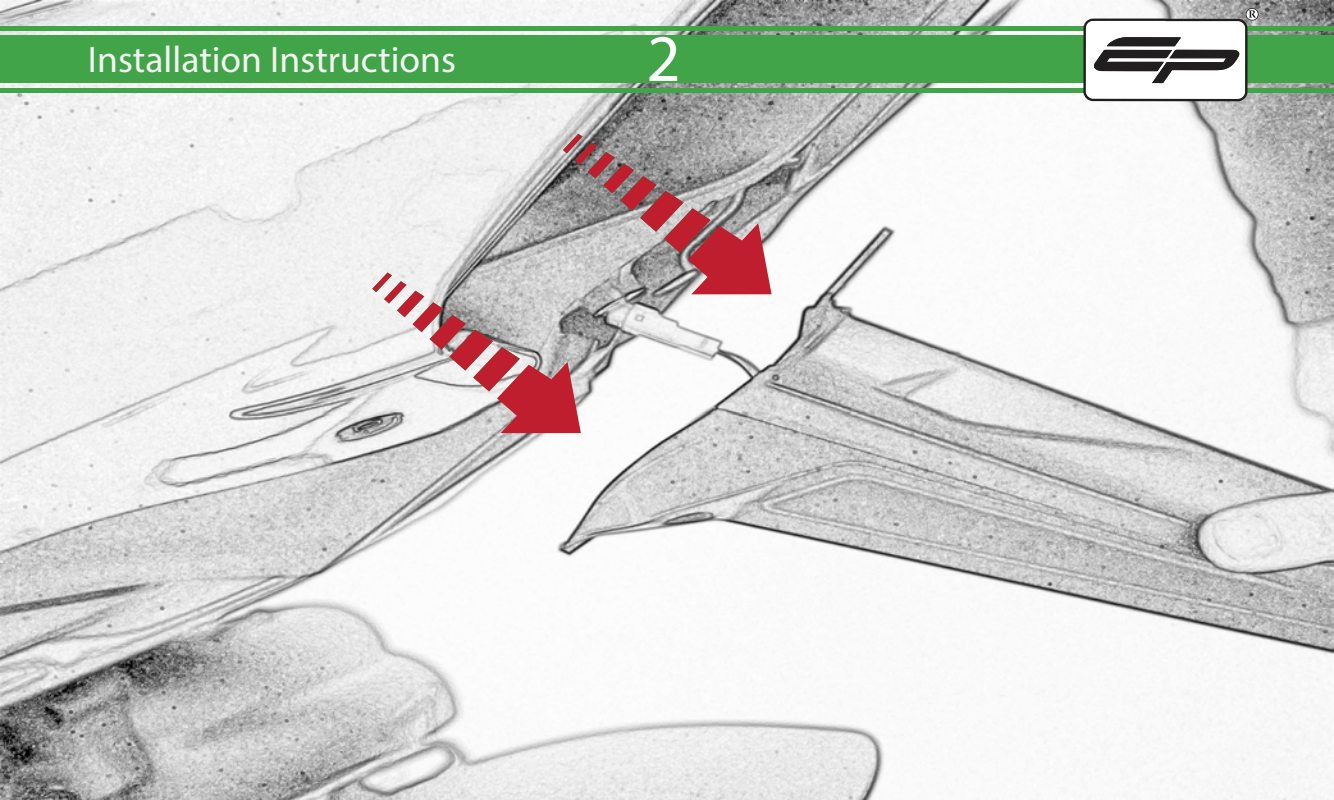

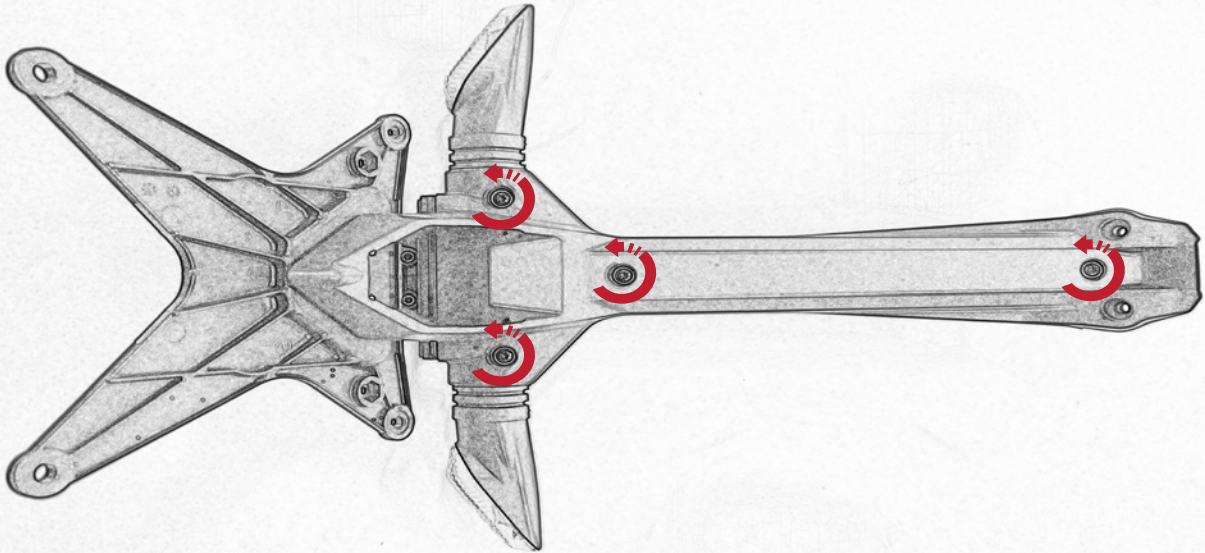

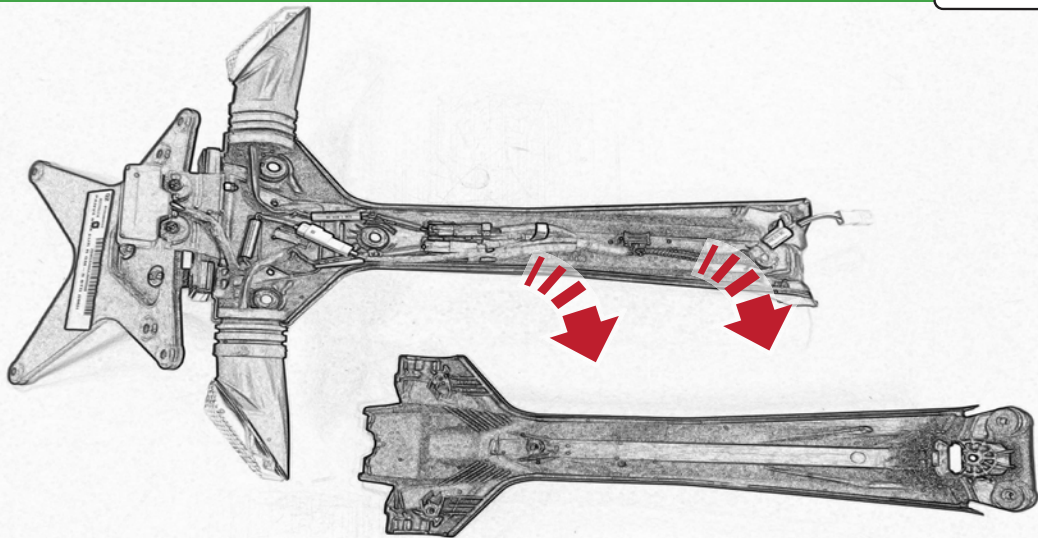

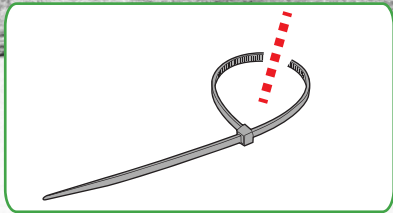
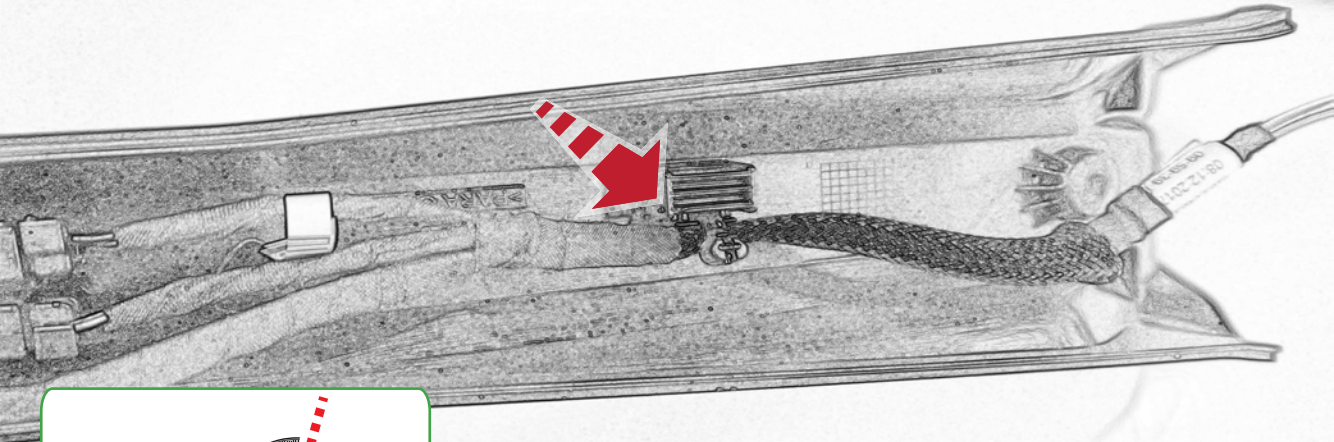

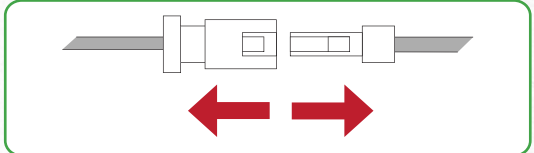
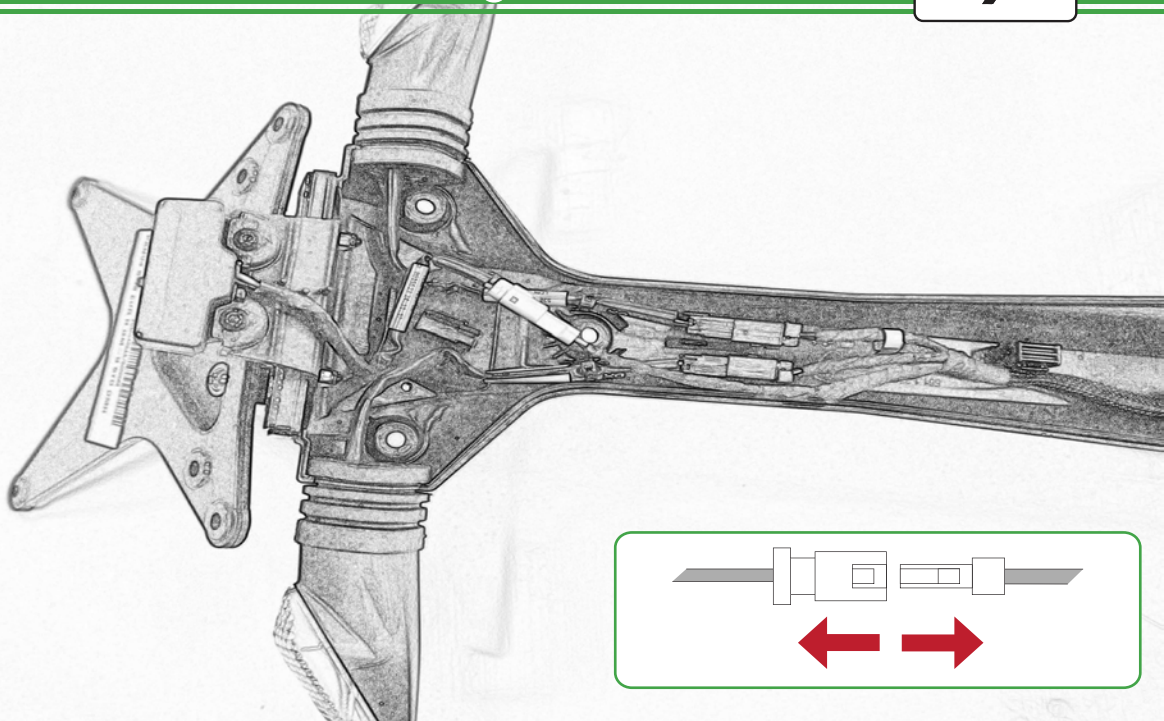

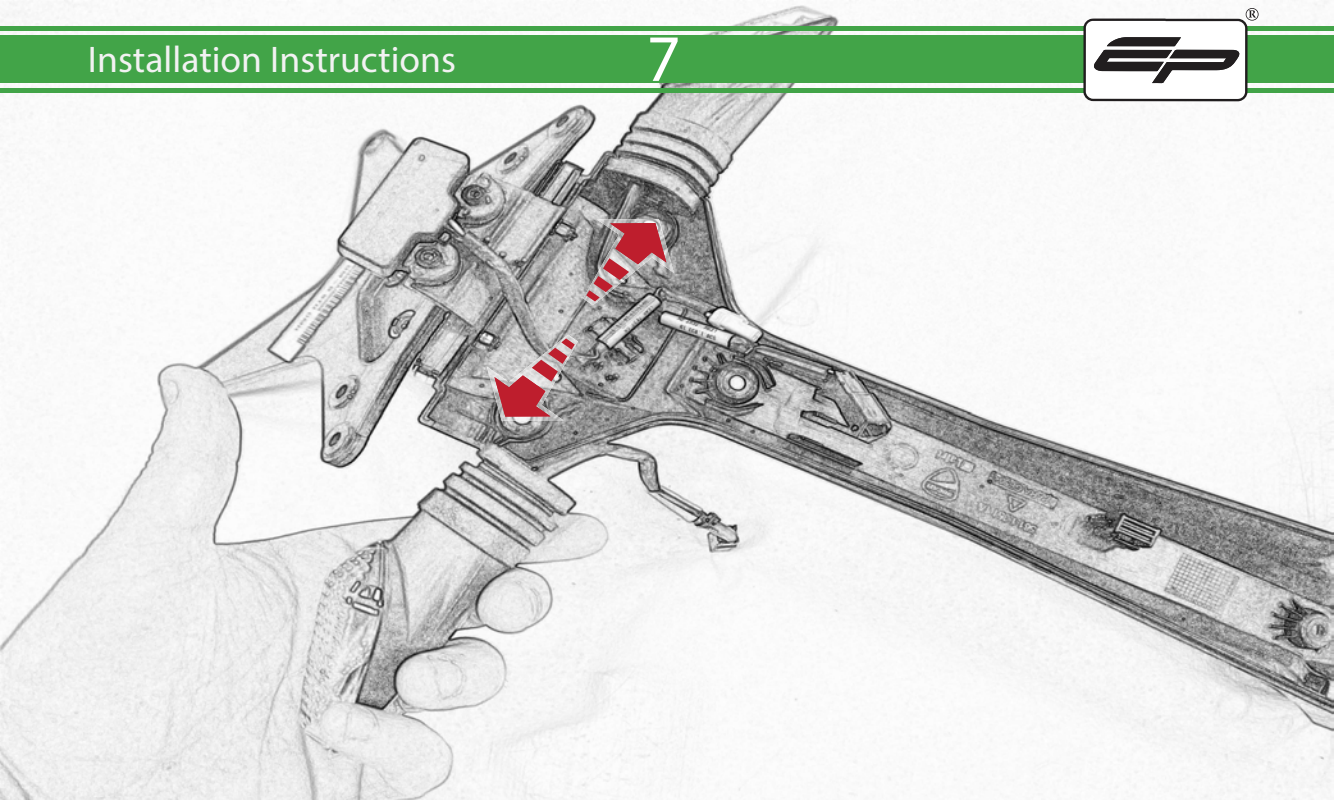

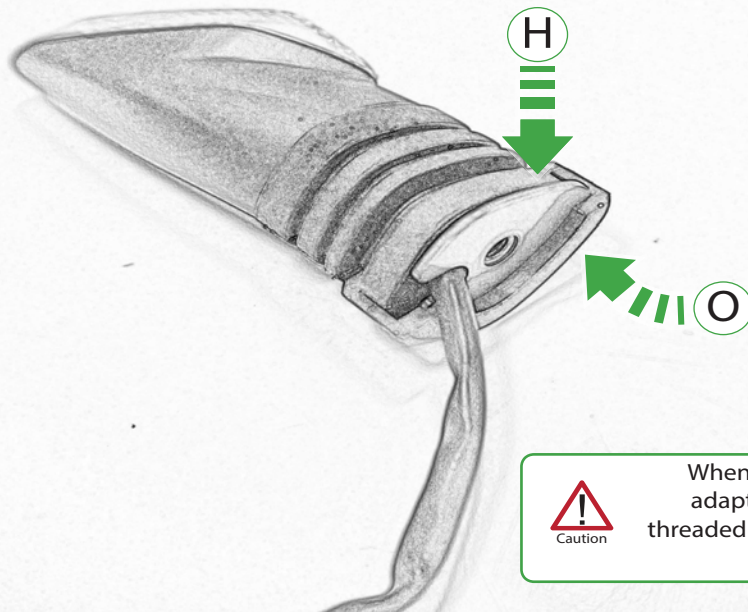

Repeat
Both Sides



When fitting the indicator
adaptor plate ensure the
threaded insert is facing towards
the indicator

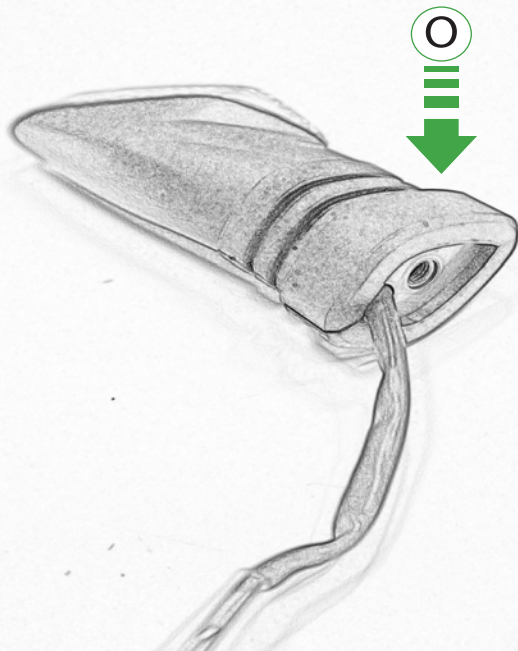

Repeat
Both Sides

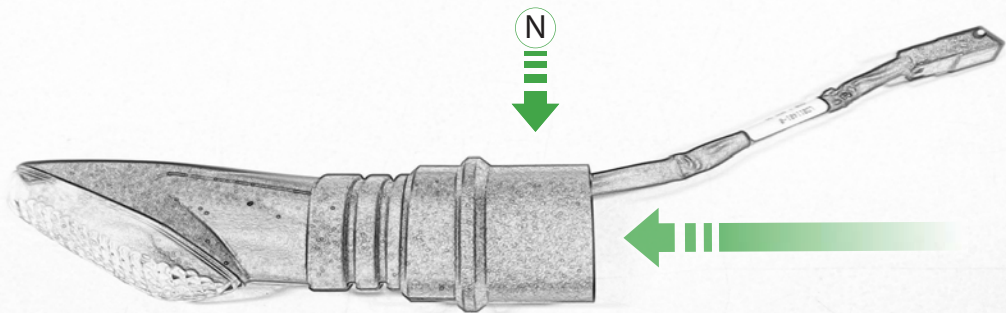

Repeat
Both Sides

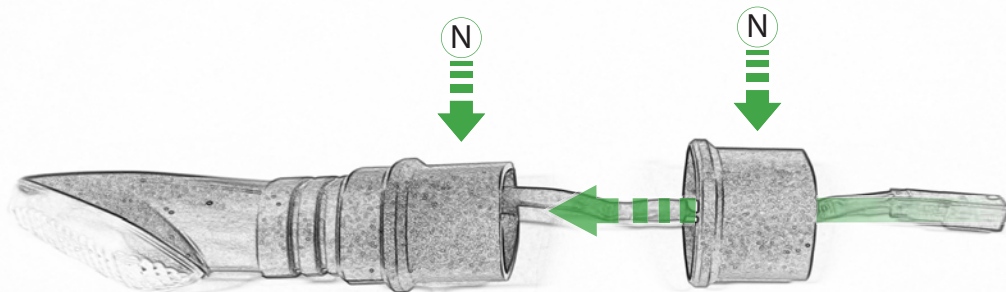

Repeat
Both Sides



Second stem only required
for large numberplates

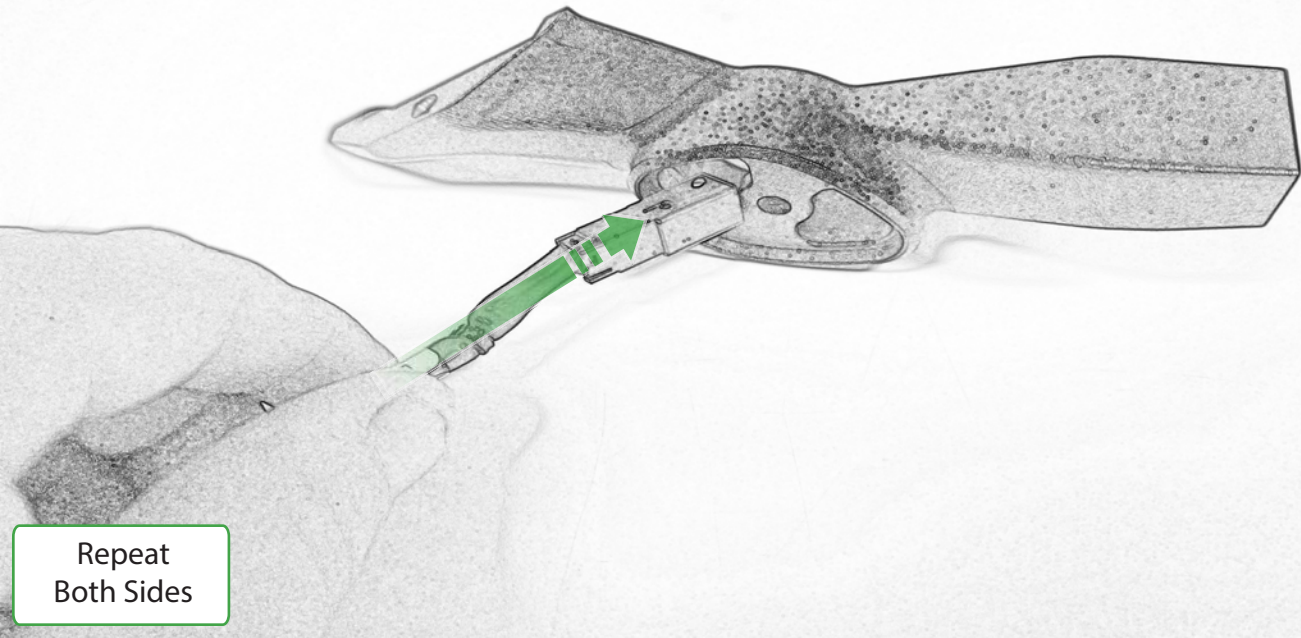

Repeat
Both Sides

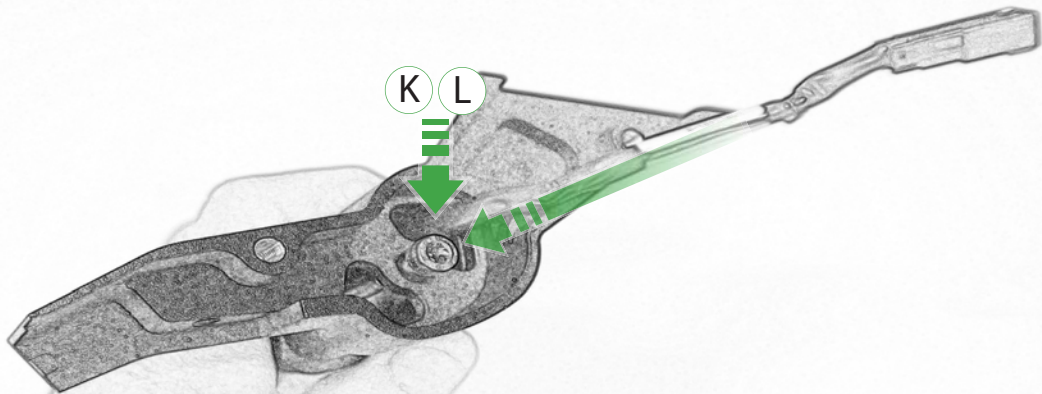

Repeat
Both Sides

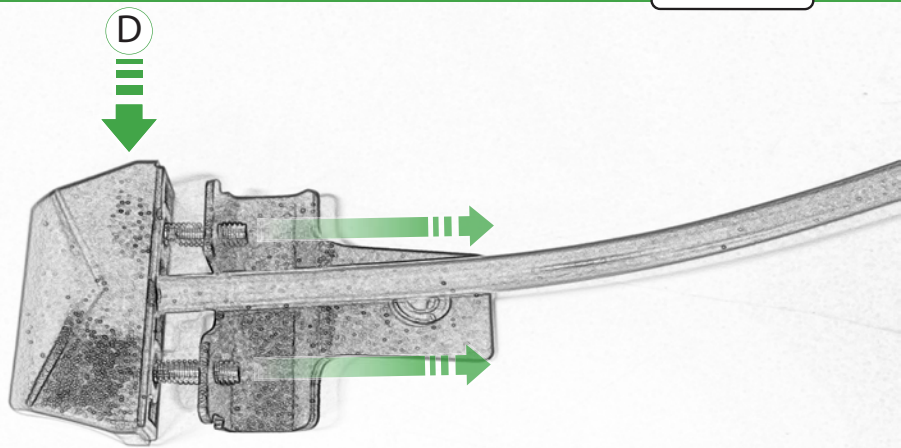

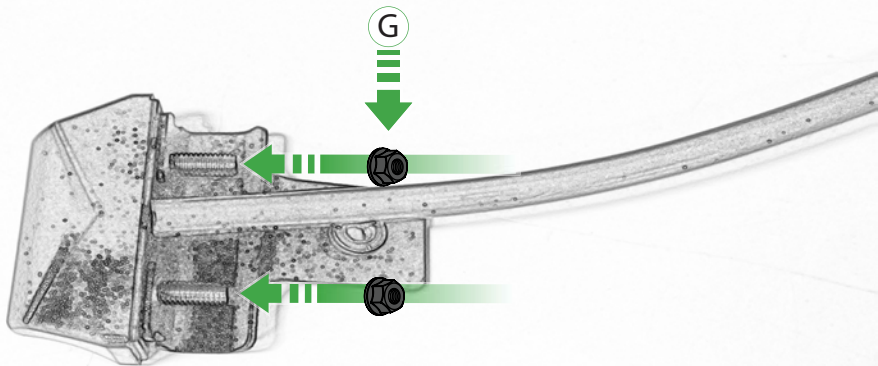

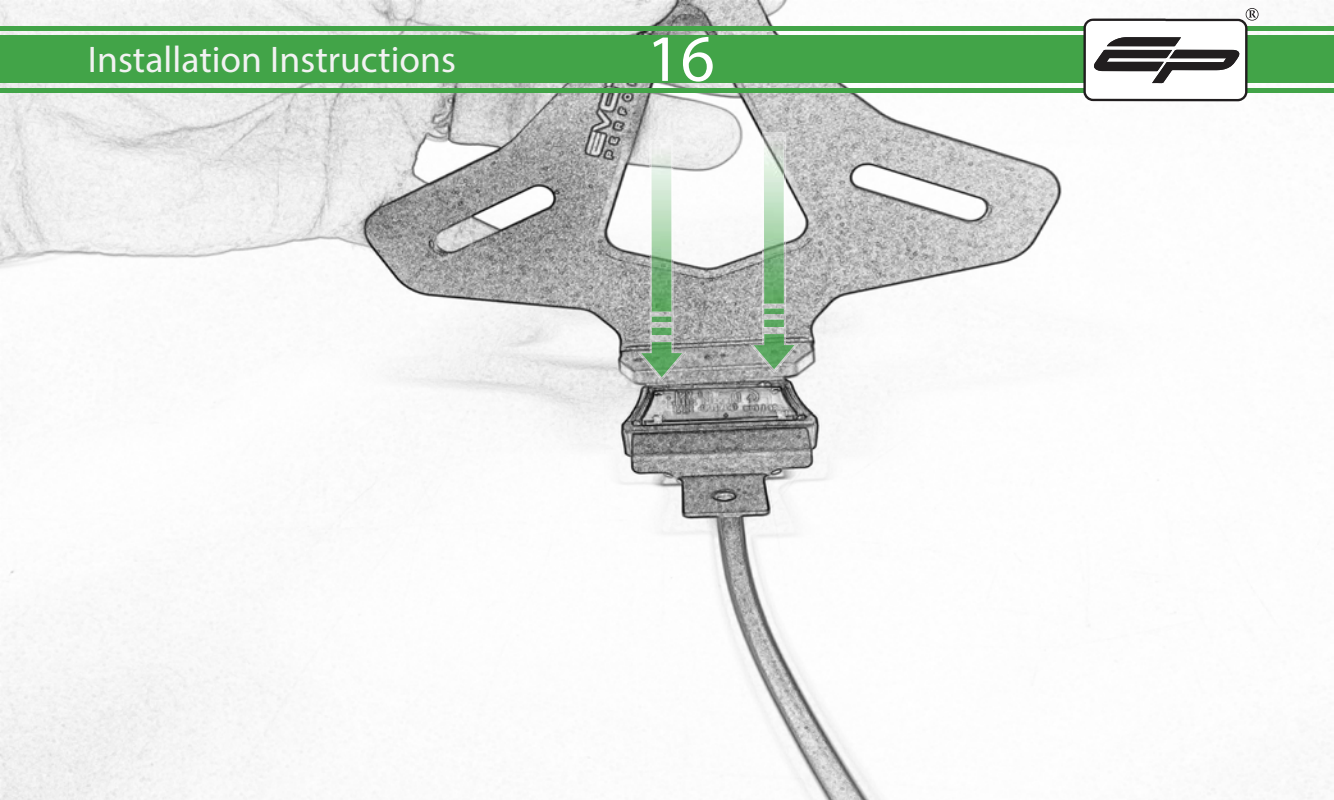

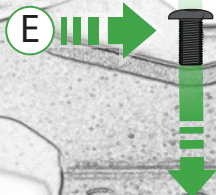

Caution

Do Not Fully Tighten

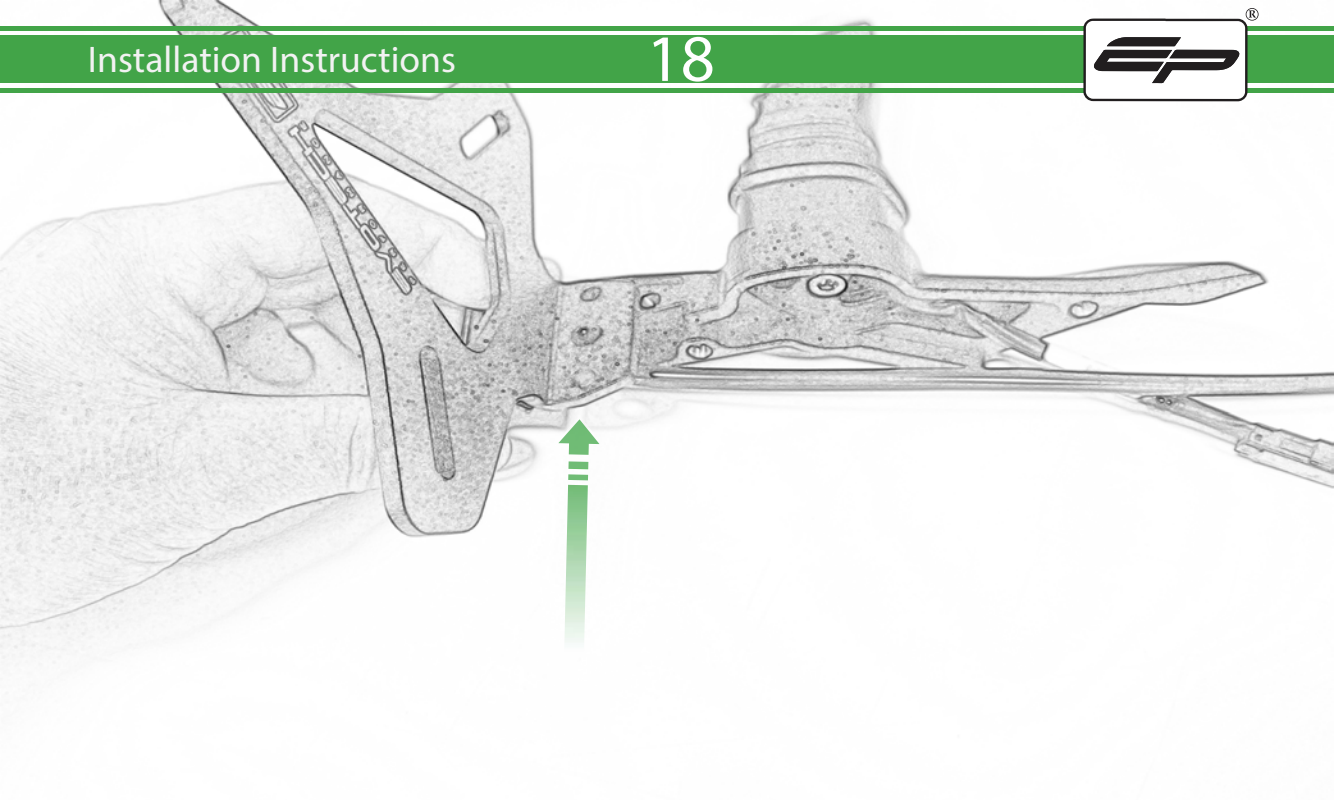

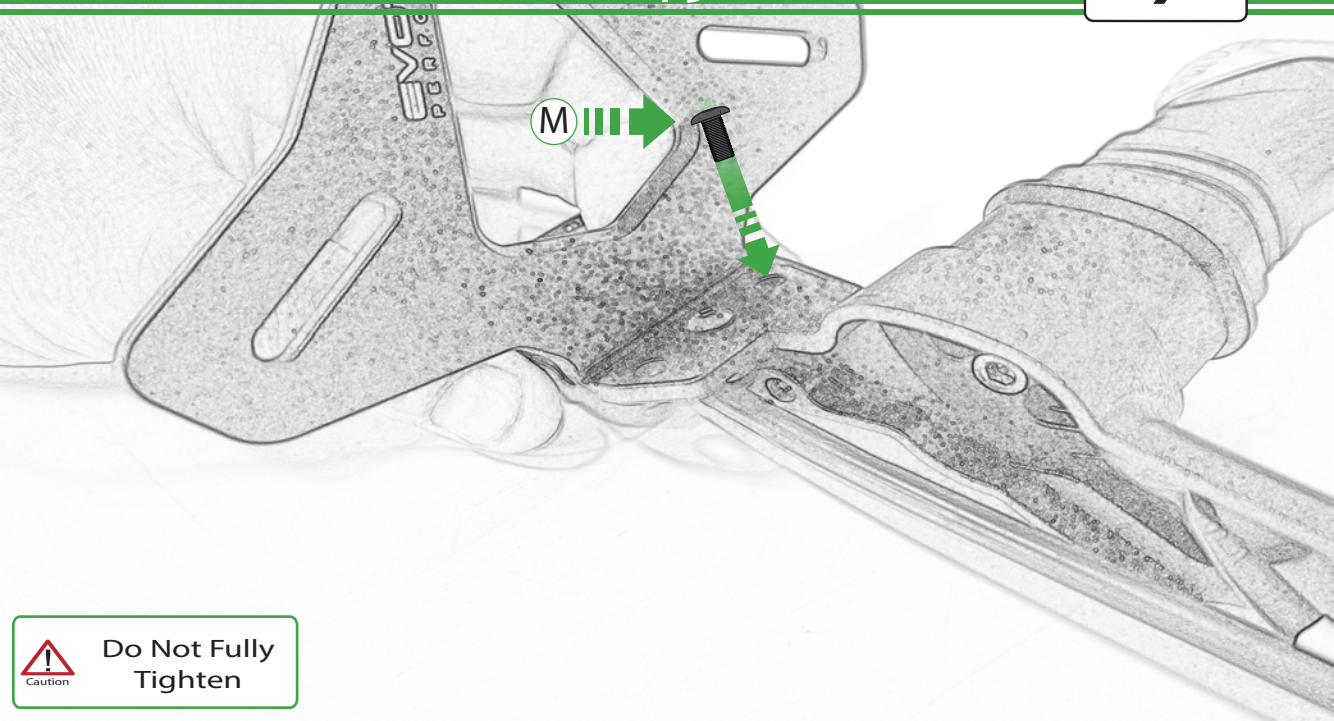

Caution

Do Not Fully
Tighten

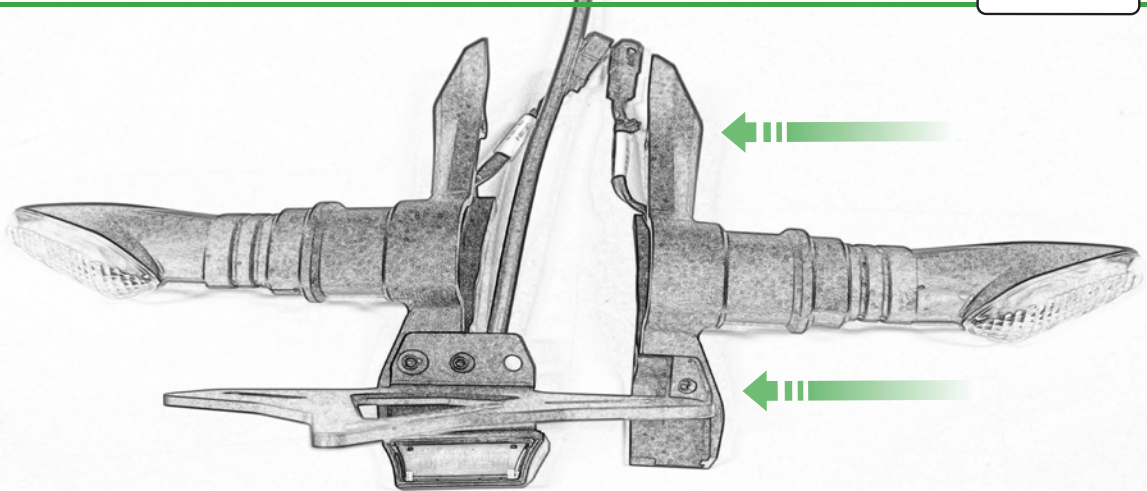

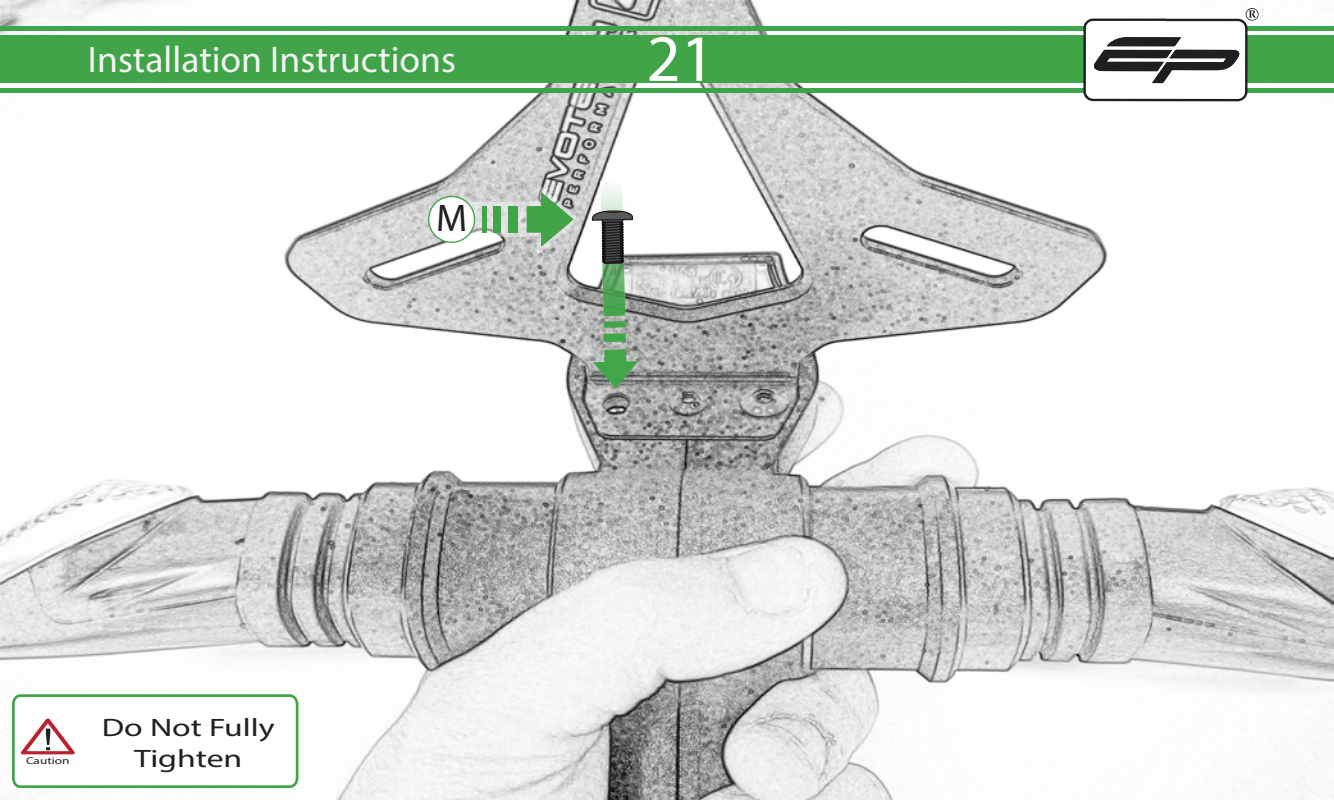

Caution

Do Not Fully Tighten

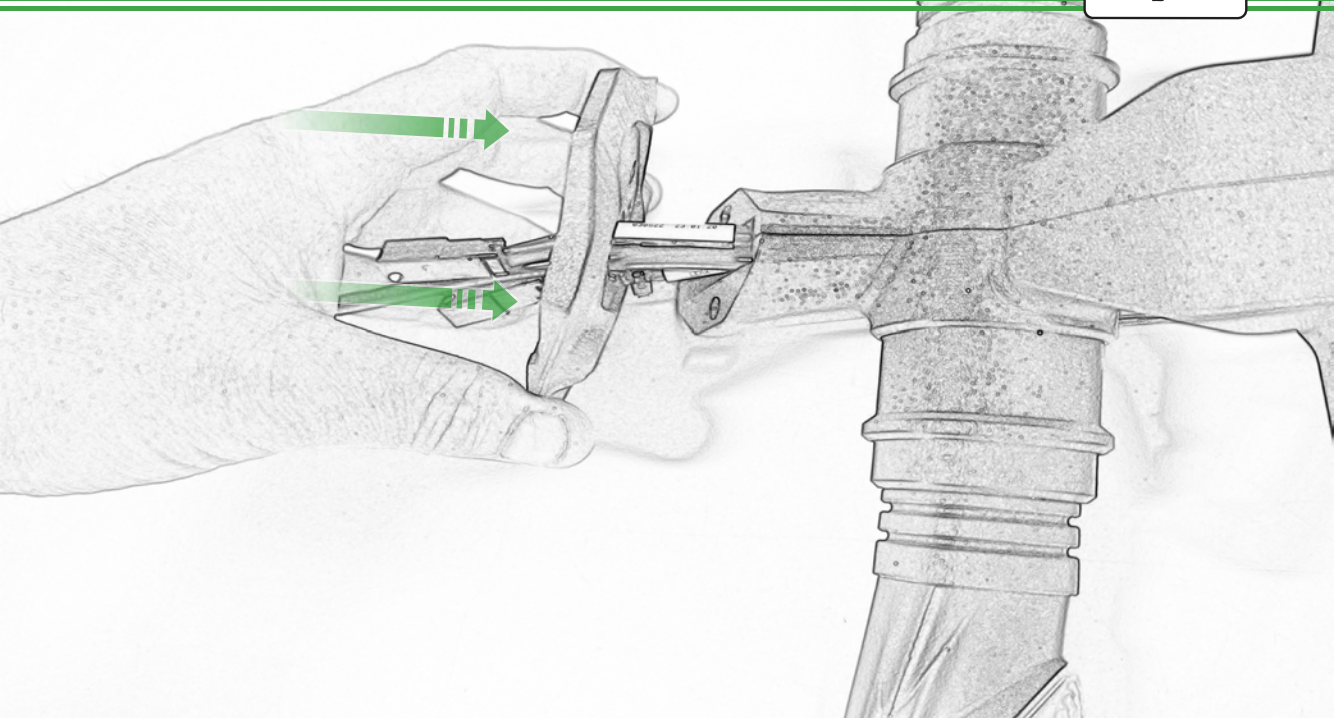

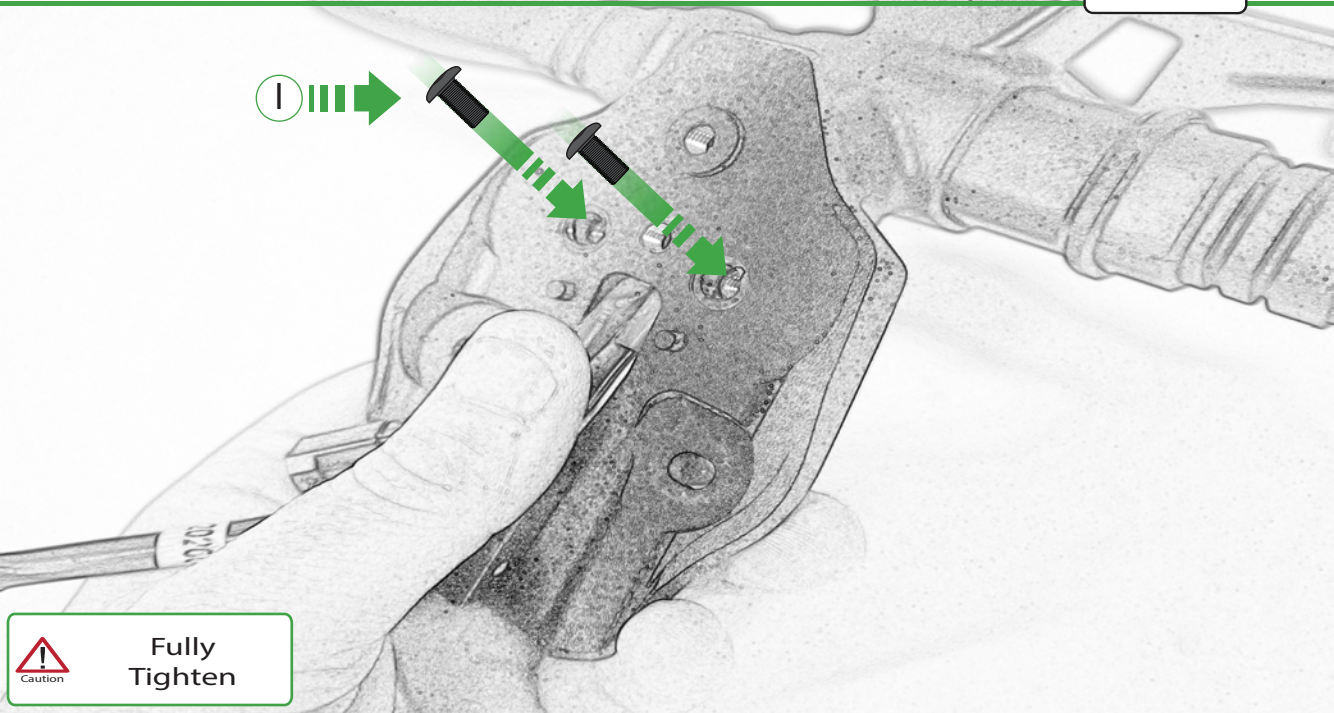
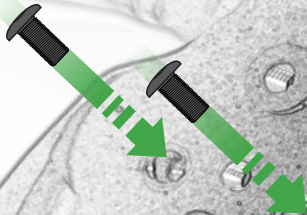

Caution

Fully
Tighten

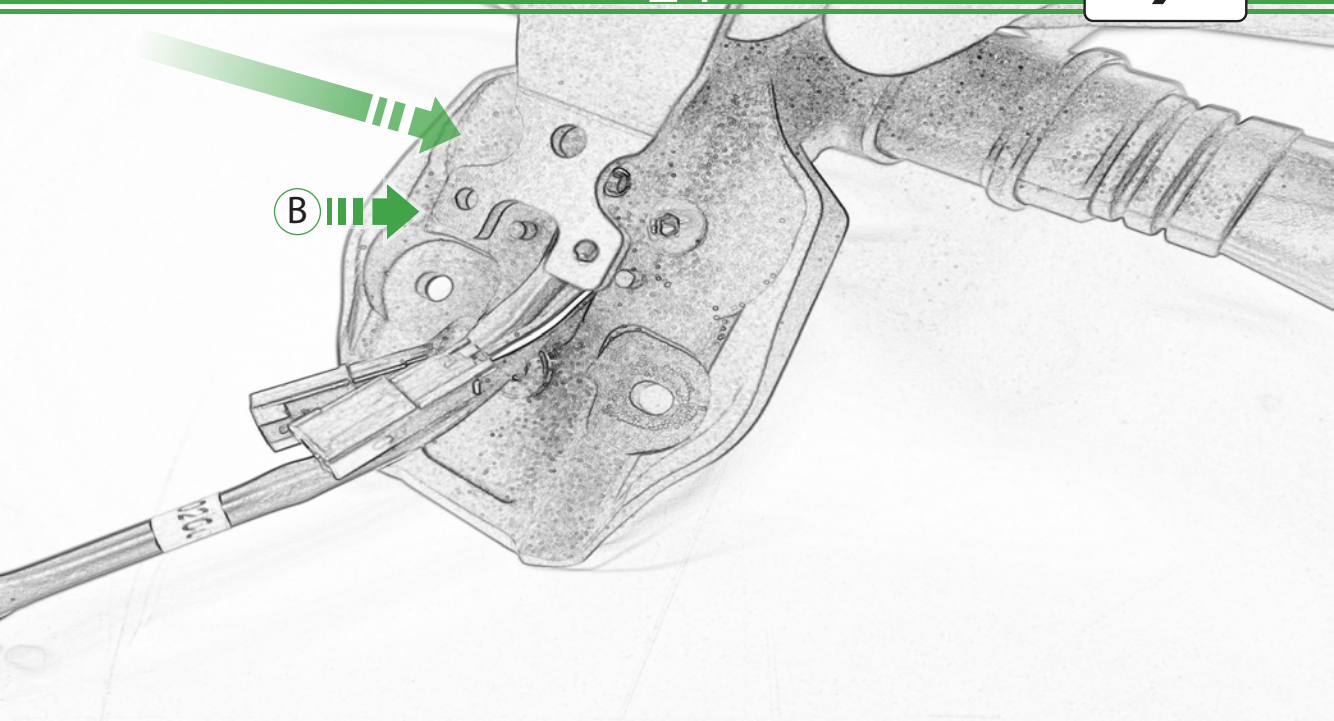

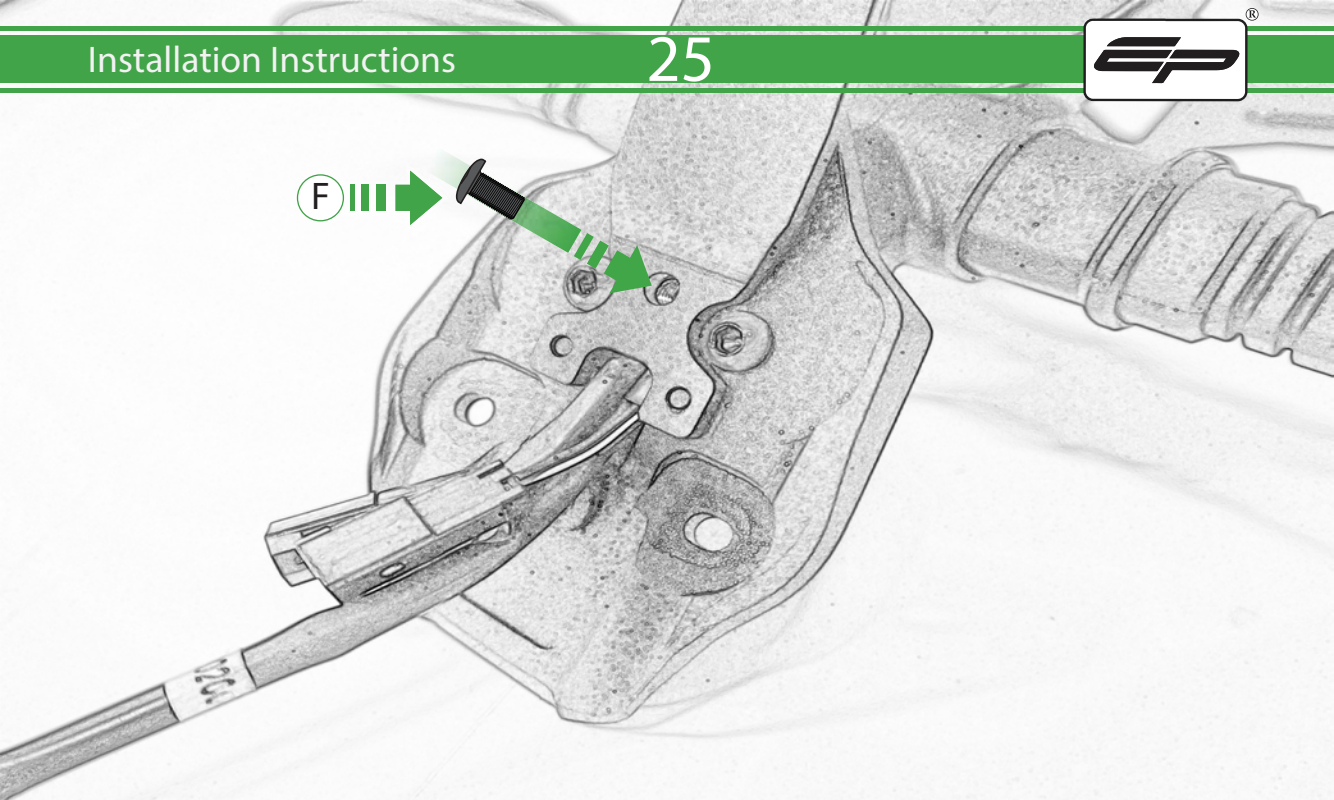

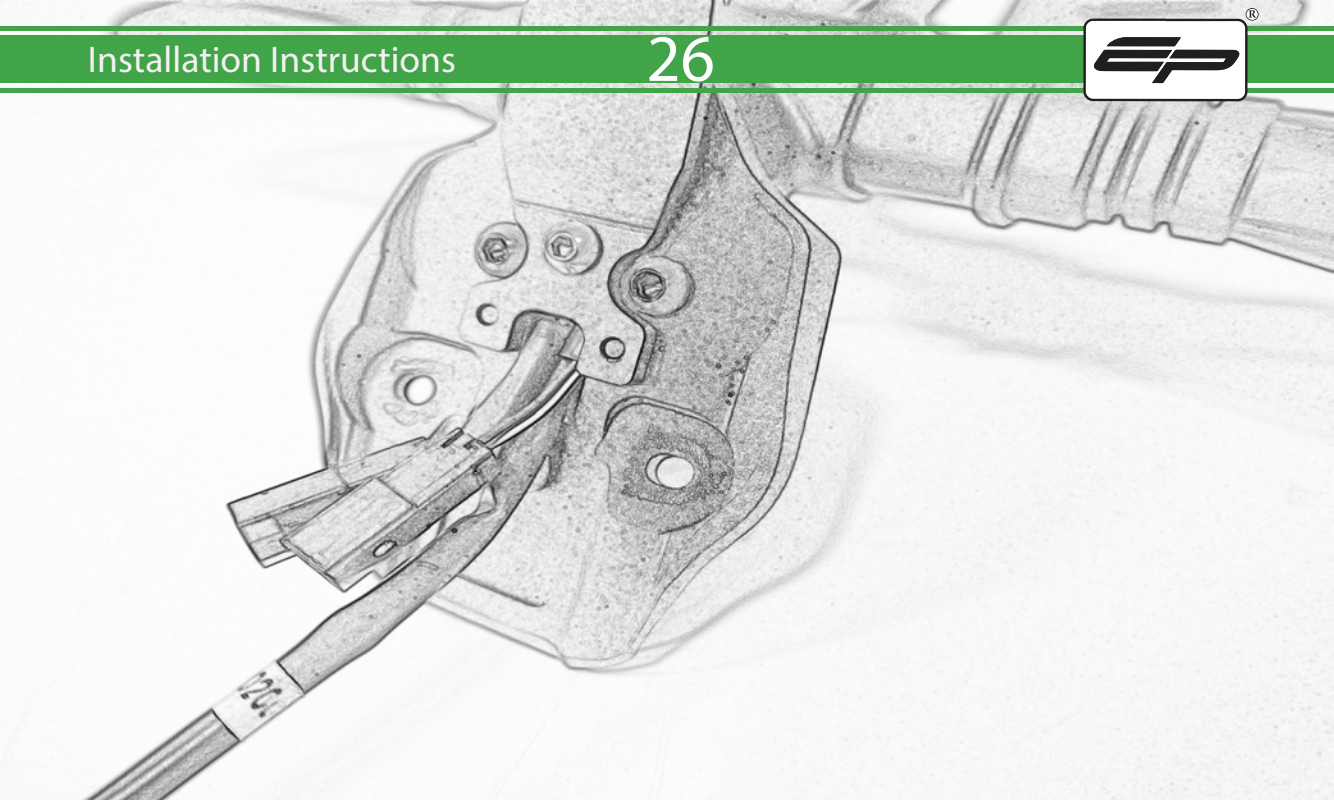

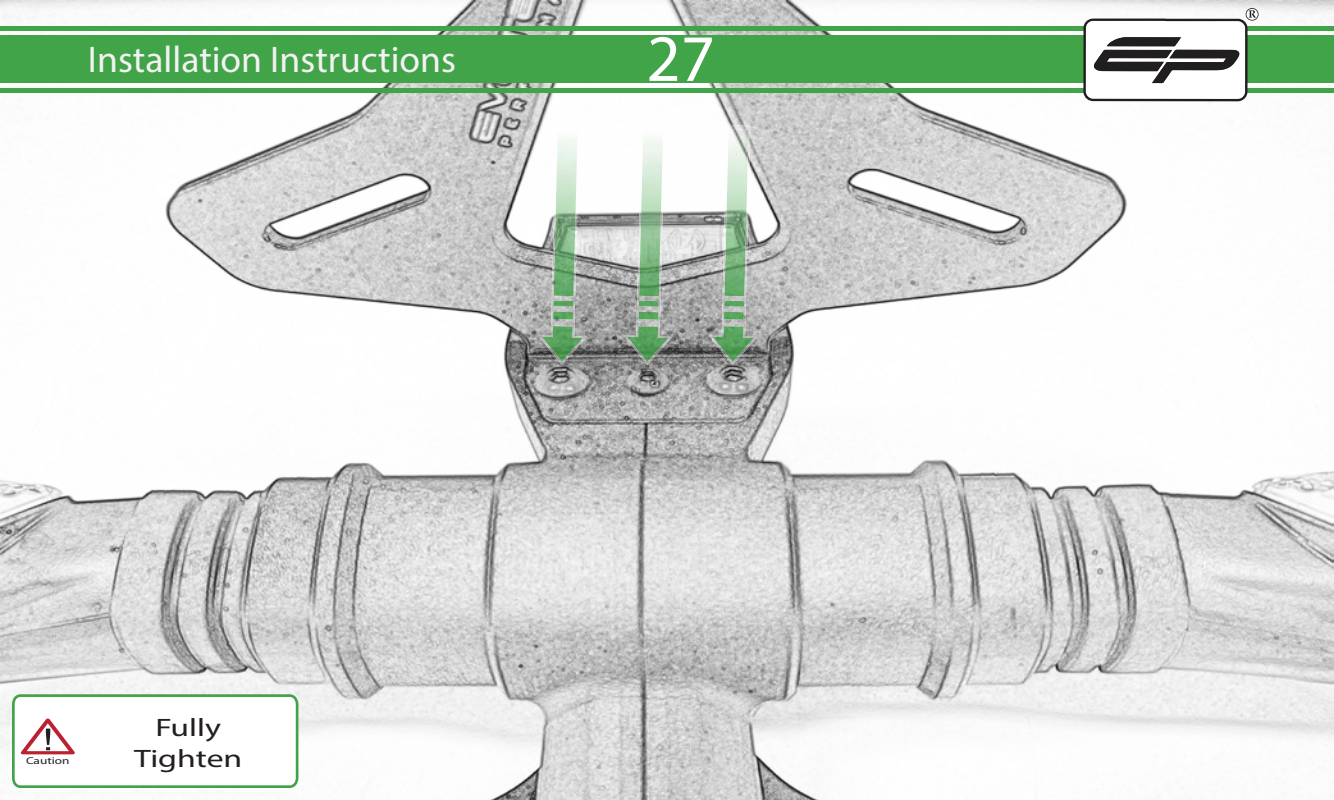

Caution

Fully
Tighten

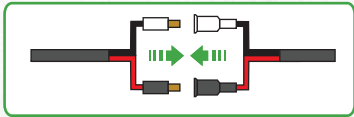
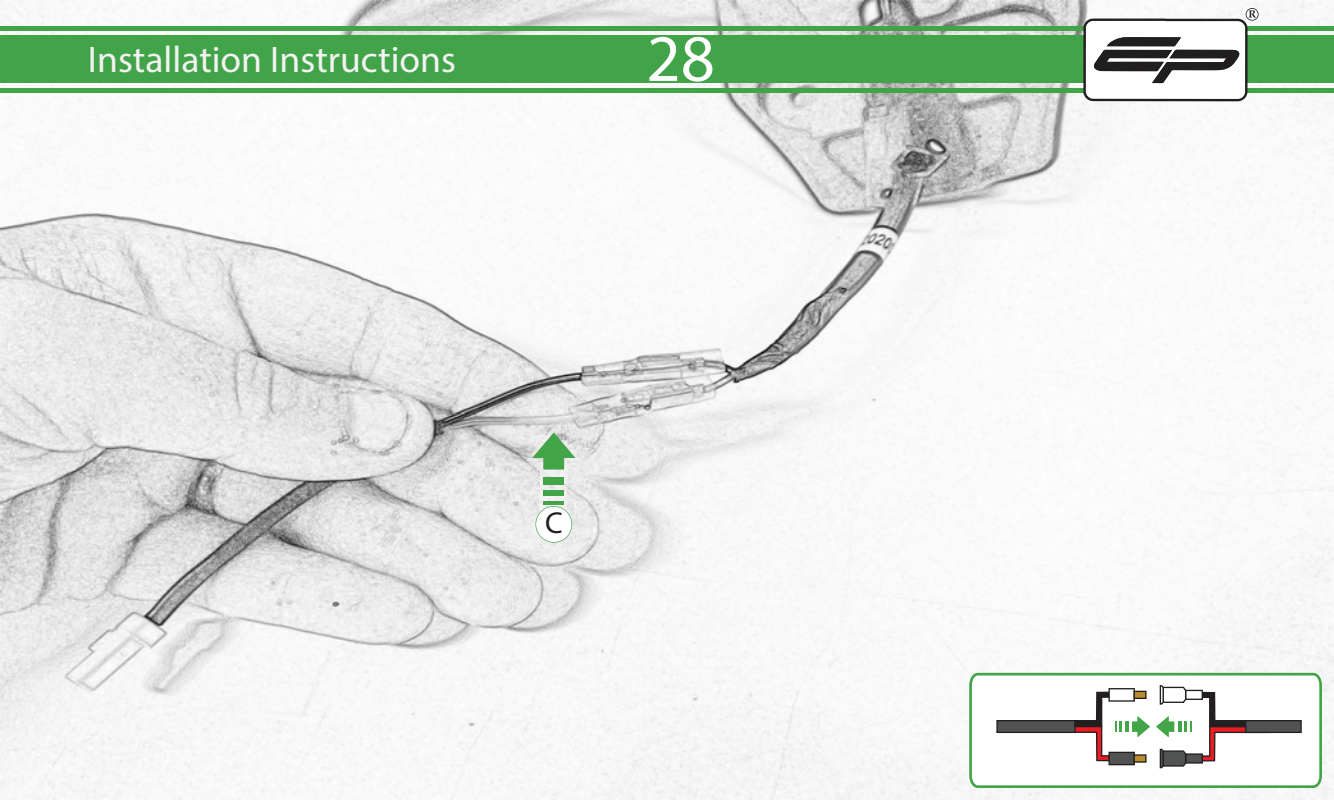

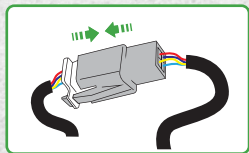
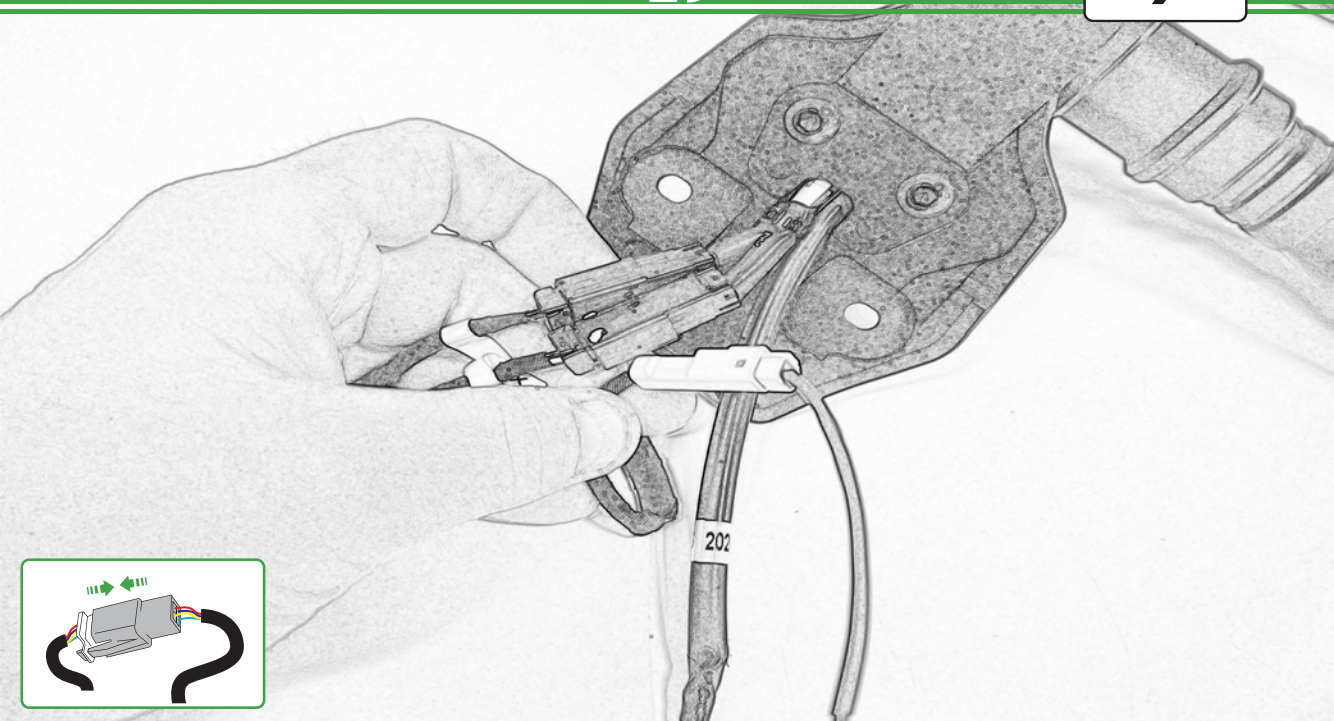

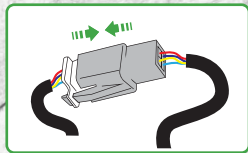
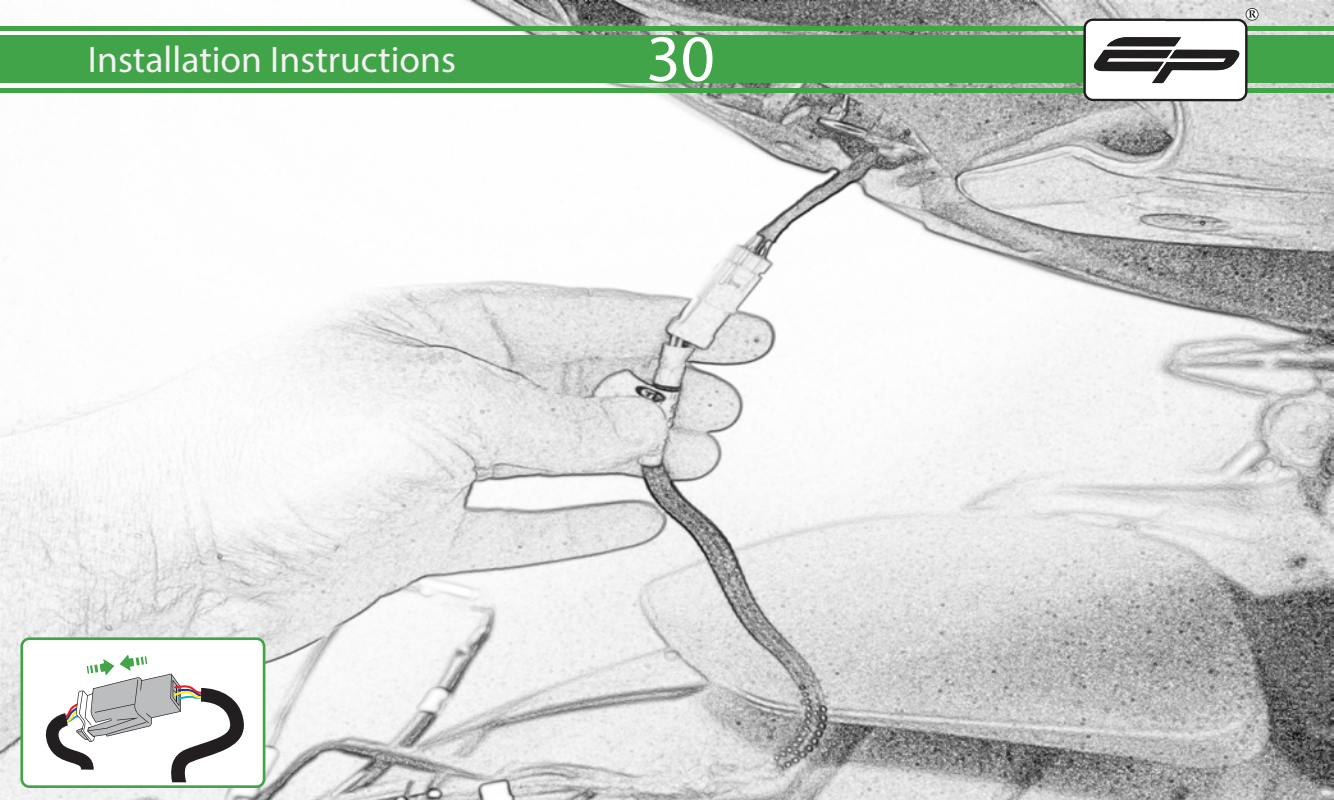

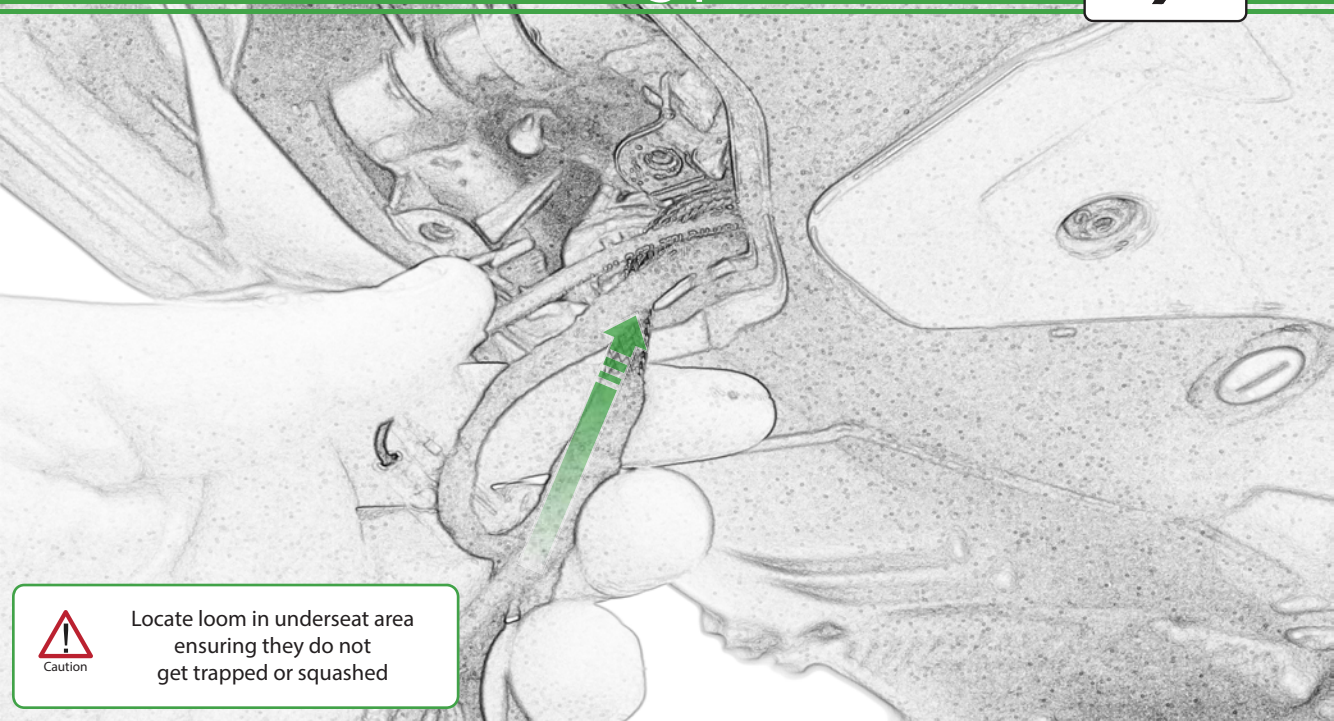

Caution

Locate loom in underseat area ensuring they do not get trapped or squashed



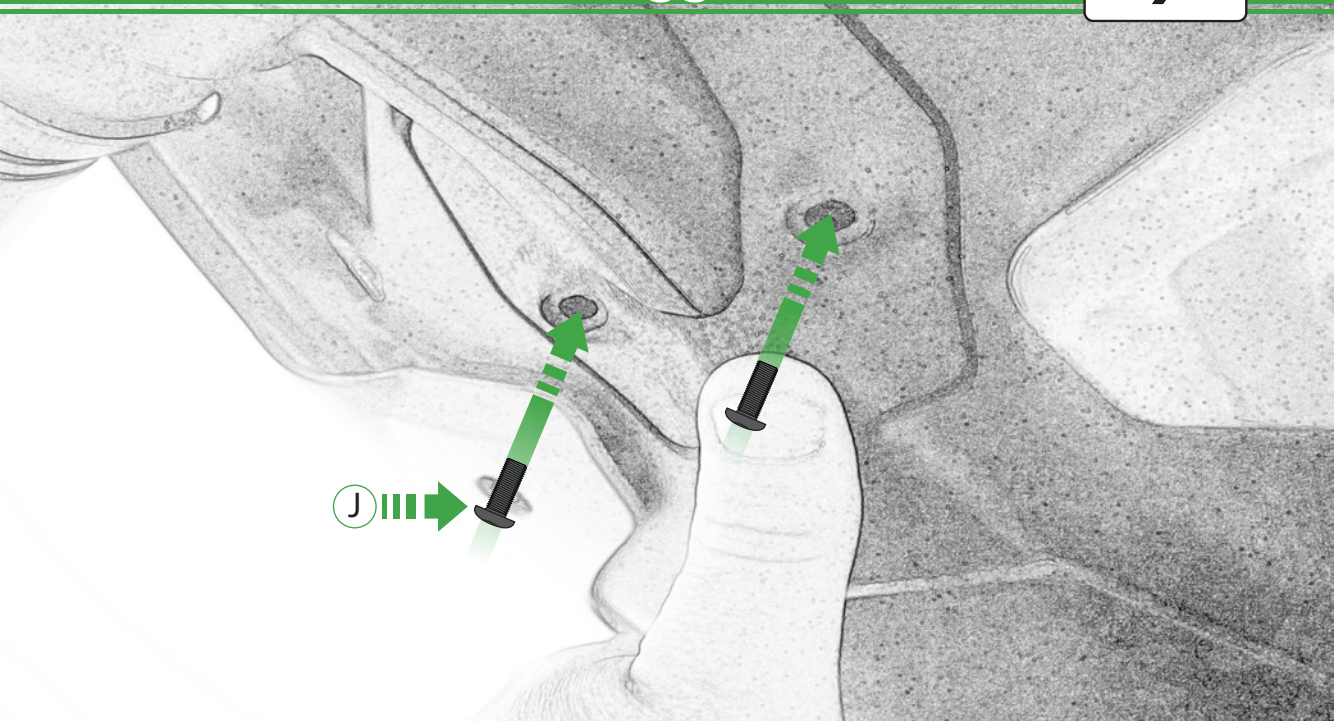

J

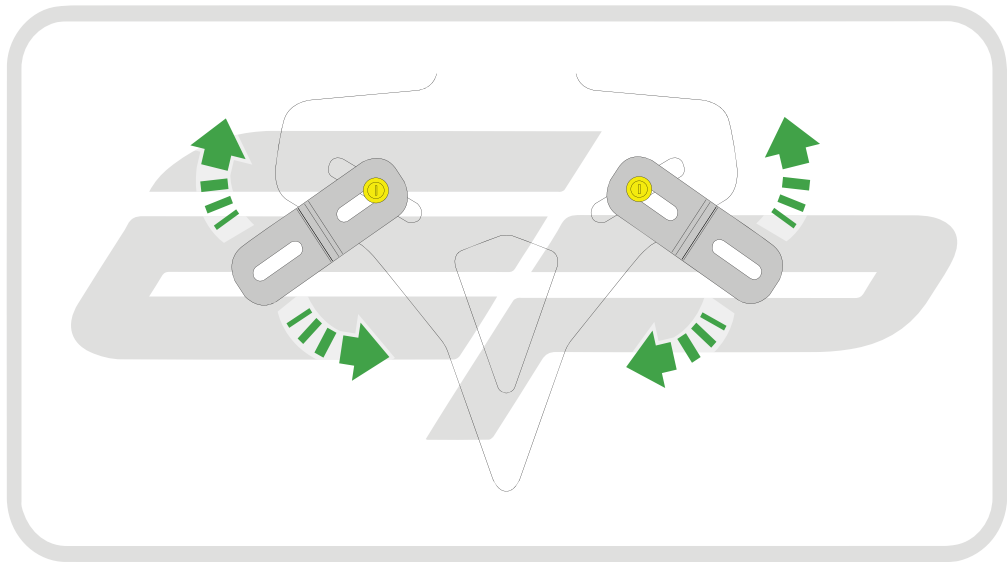

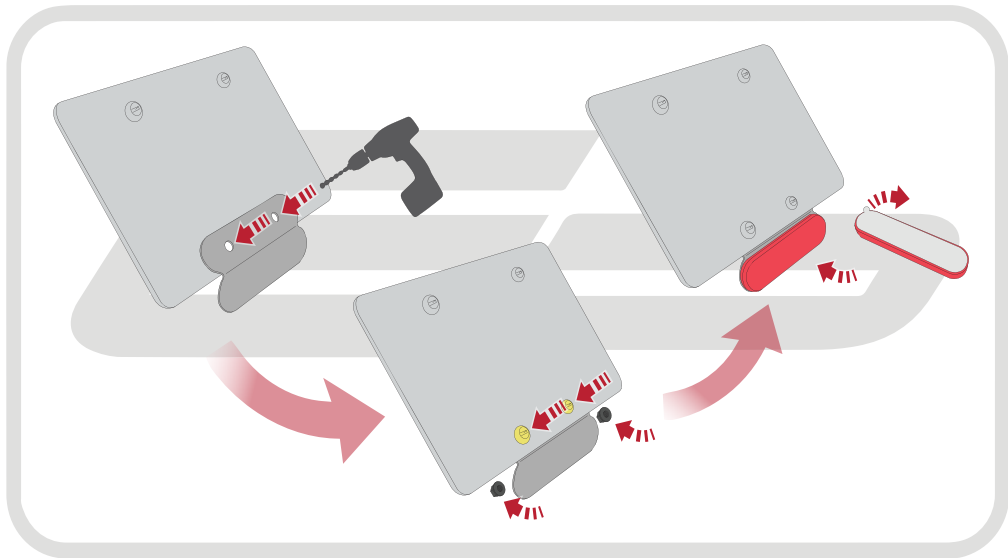



ESSENTIAL CHECKS



After installation of your tail tidy ensure that the licence plate does not contact the rear tyre when suspension is fully compressed.

Ensure all electrics including indicators, tail light, brake light and licence plate light lights are working correctly before riding the motorcycle.

It is recommended that periodic inspections are made to ensure that all fixings are fully tightend.



EVOTECH®
P E R F O R M A N C E

www.evotech-performance.com