

EVOTECH®
P E R F O R M A N C E

www.evotech-performance.com

Triumph Trident Tail Tidy
Installation Instructions



Kit Contents PRN015396

- (A) 1 x BMW Light
- (B) 1 x Connector Type 25
- (C) 1 x Connector Type 23
- (D) 1 x M8 x 20mm Button Head Bolts
- (E) 1 x M5 x 16mm Button Head Bolts
- (F) 1 x M5 Washer
- (G) 1 x Back Spacer
- (H) 1 x Front Spacer
- (I) 1 x Support Bracket
- (J) 1 x Number Plate Bracket
- (K) 1 x Main Right Body
- (L) 1 x Main Left Body
- (M) 4 x M6 Flange Nut
- (N) 6 x M6 x 16 Button Head Bolts

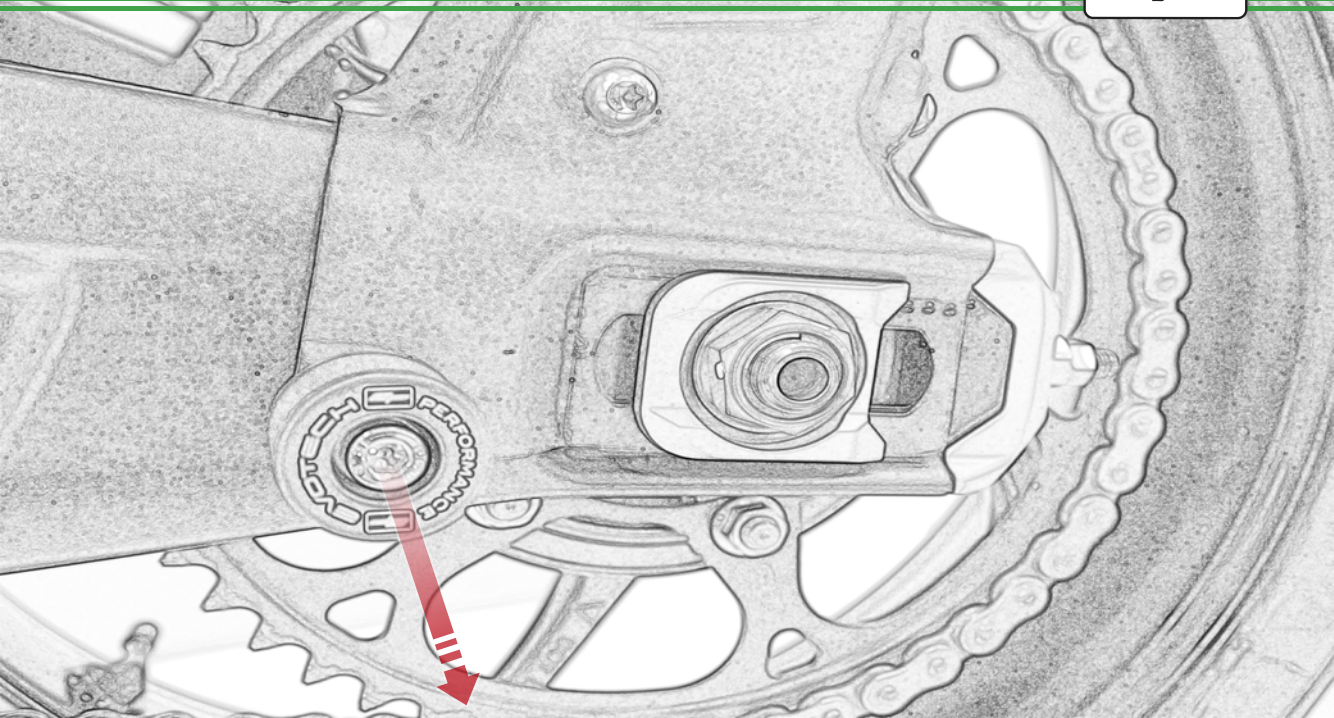

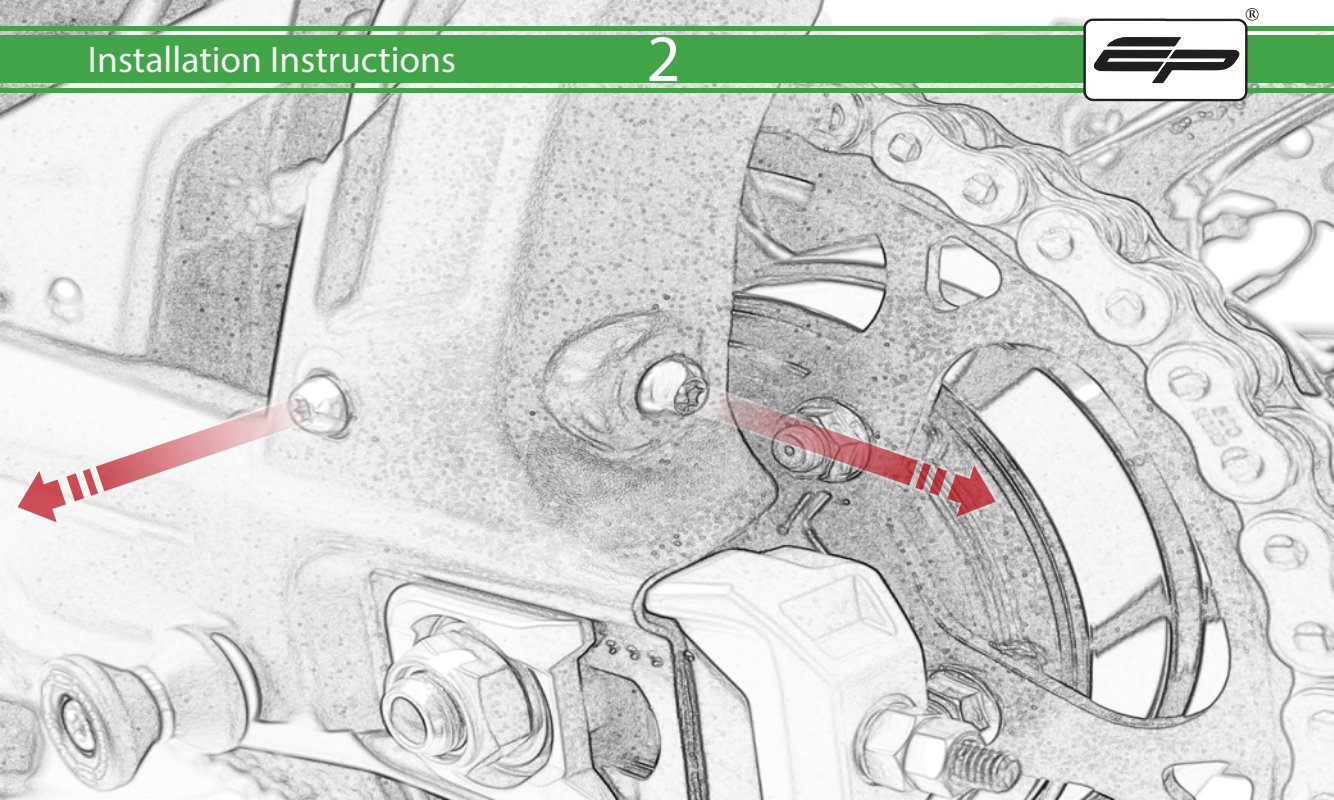



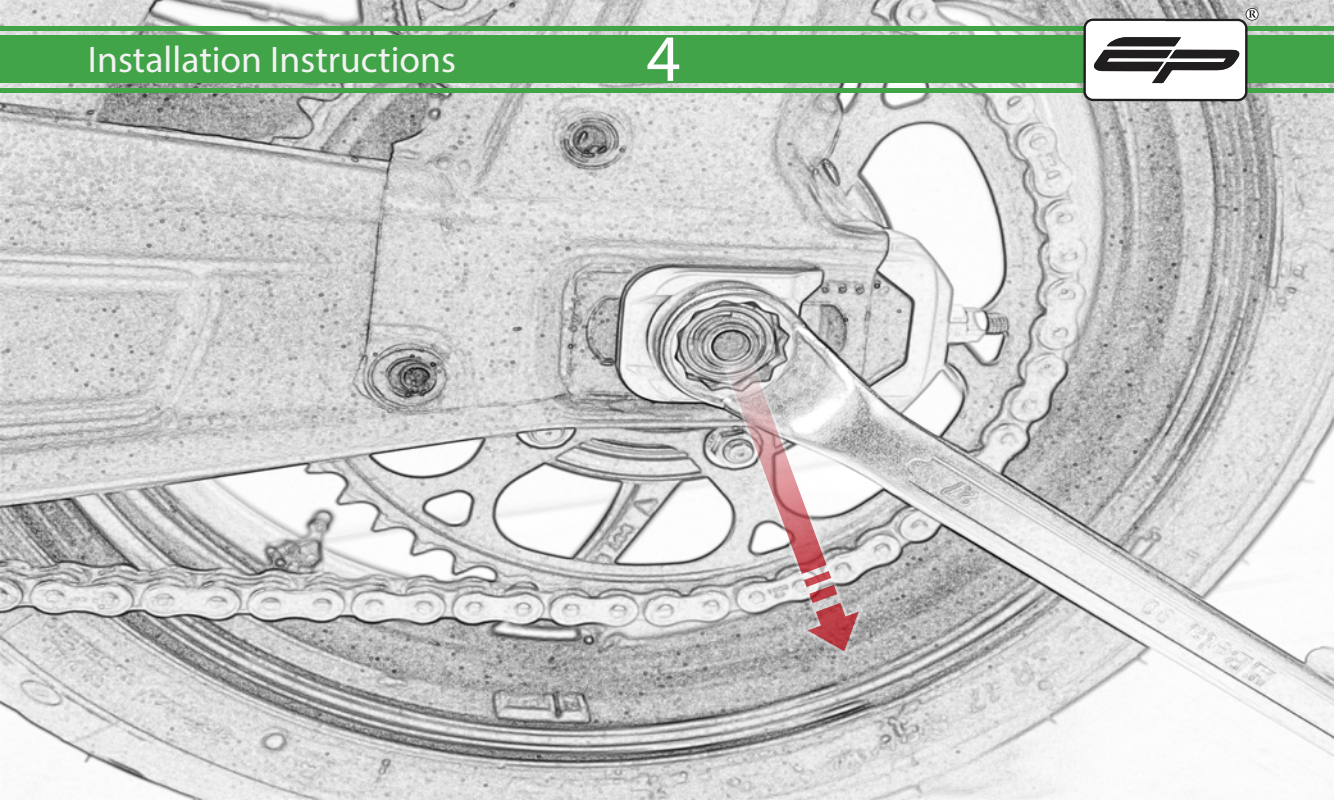

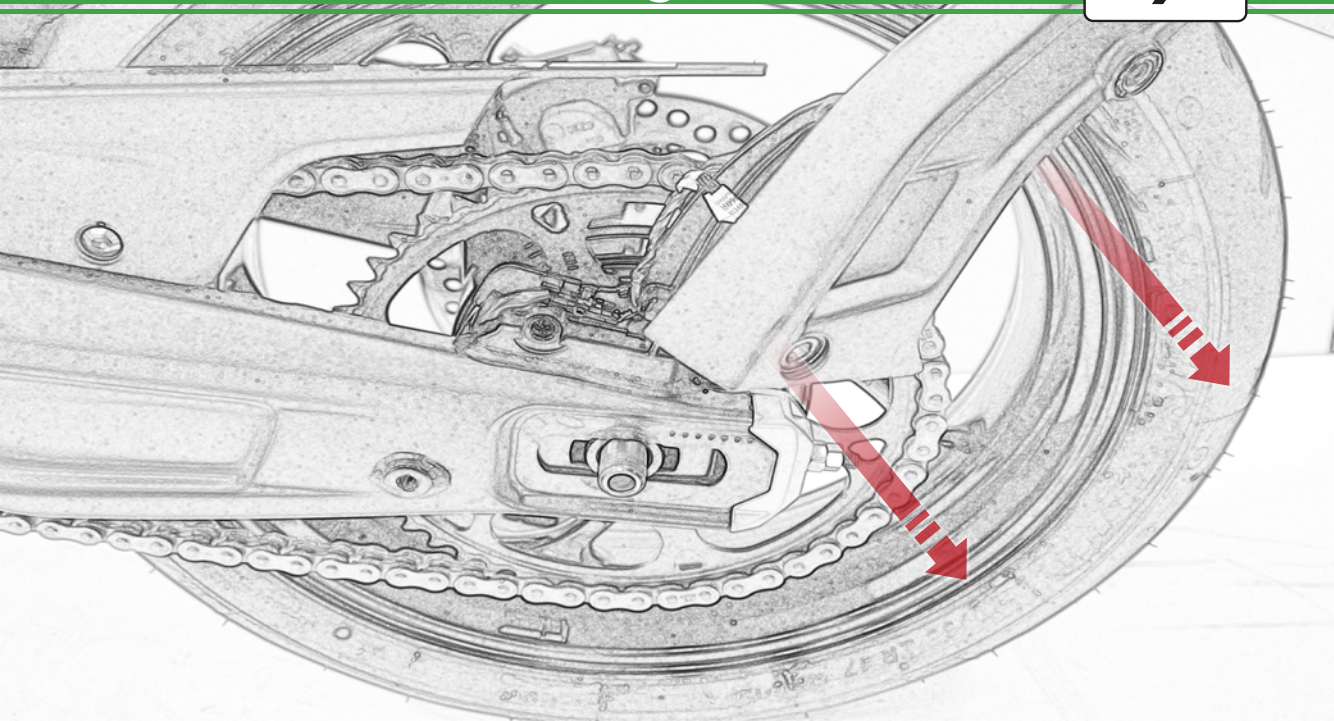

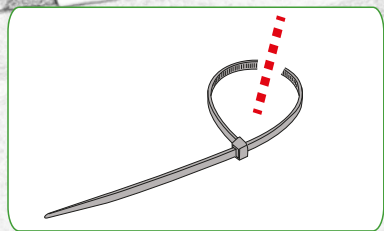
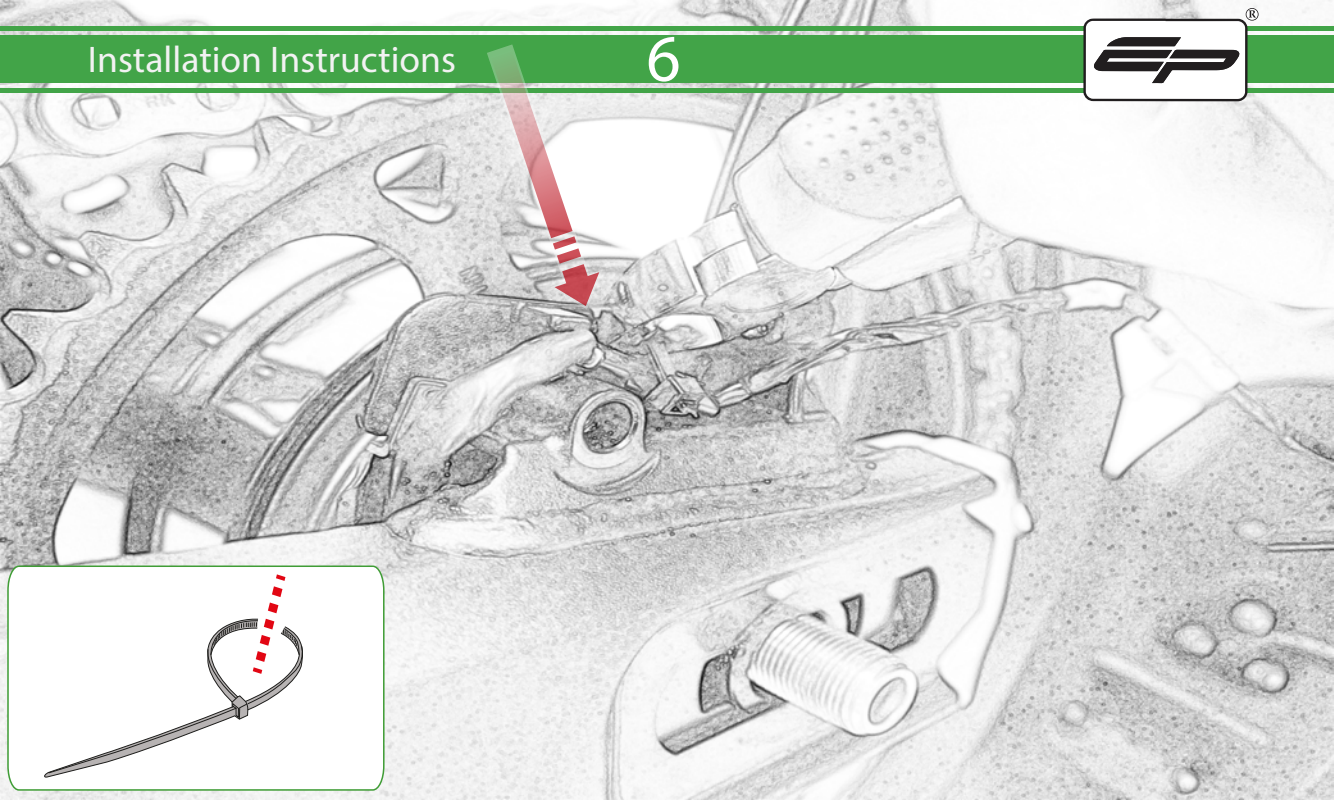

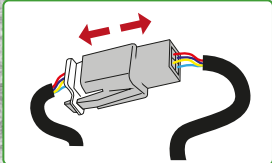
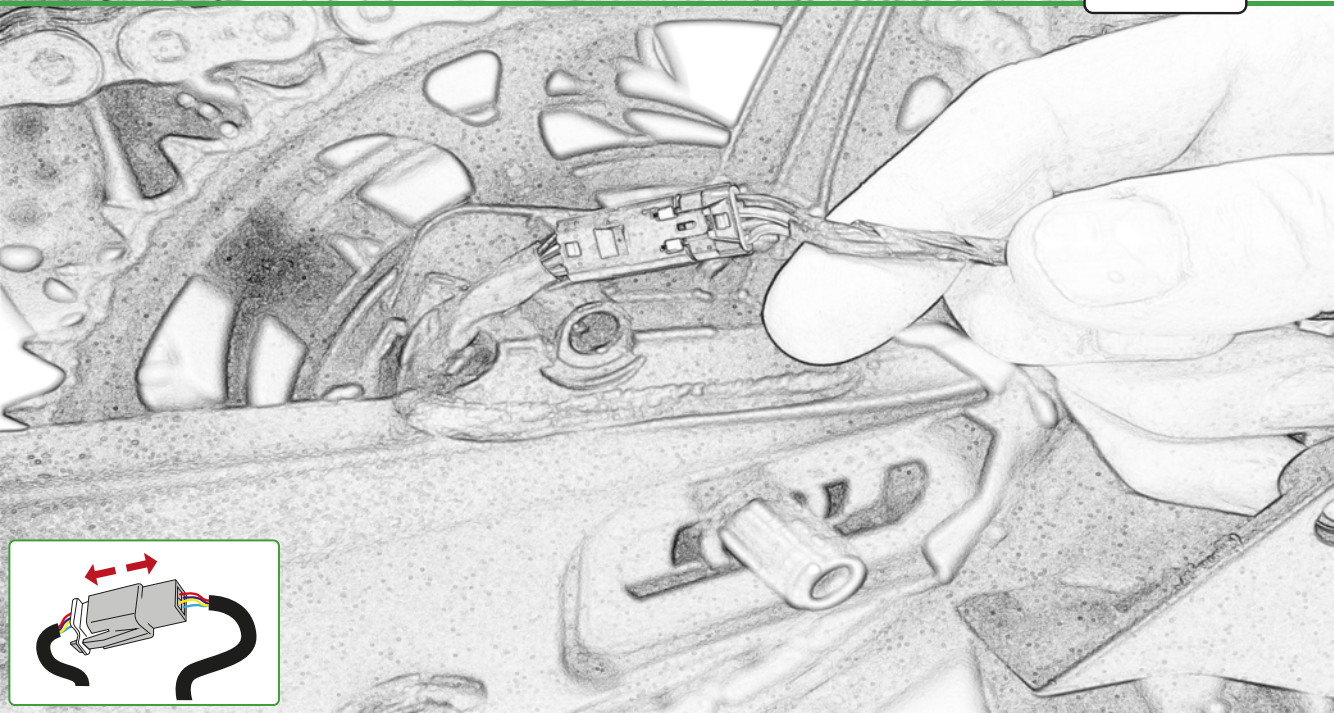

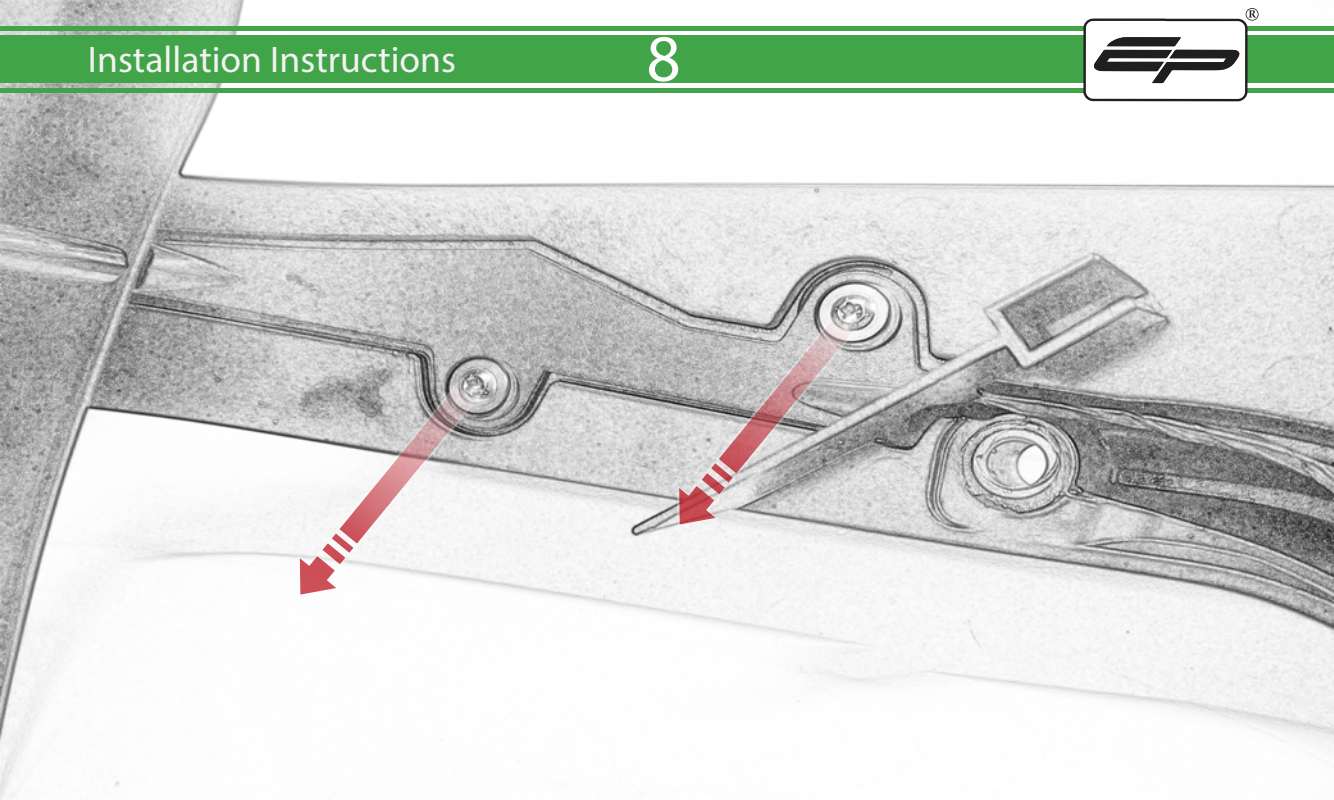

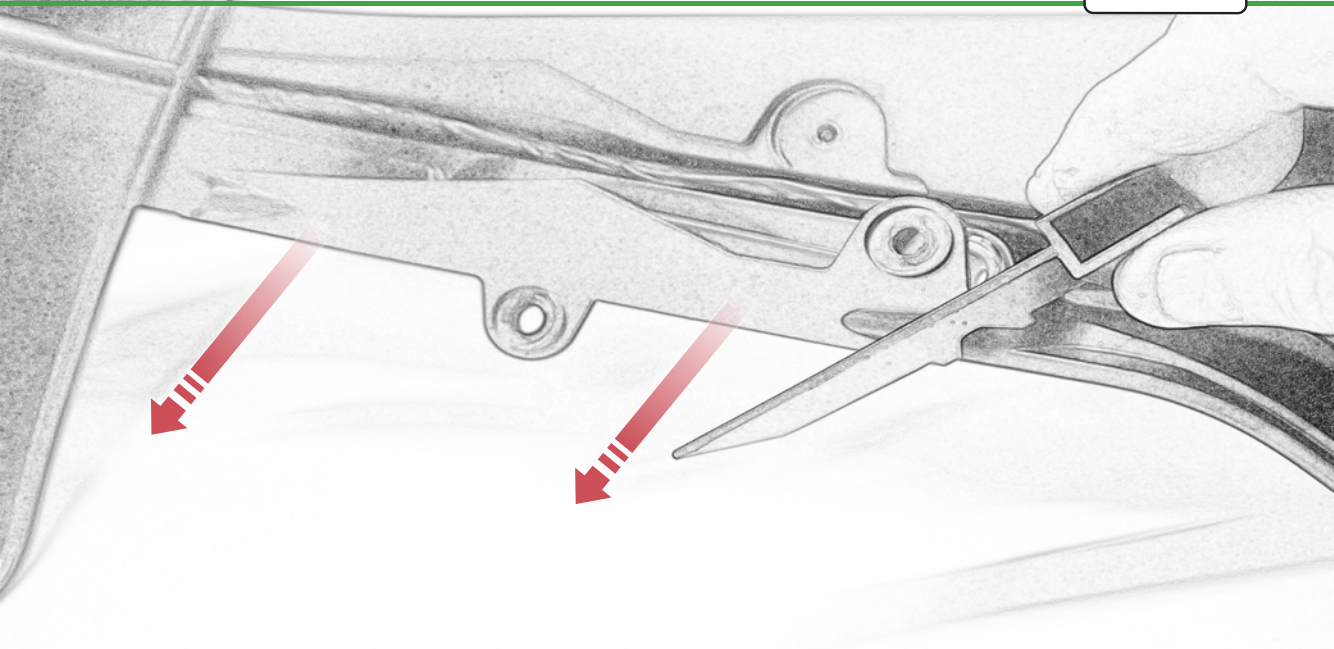

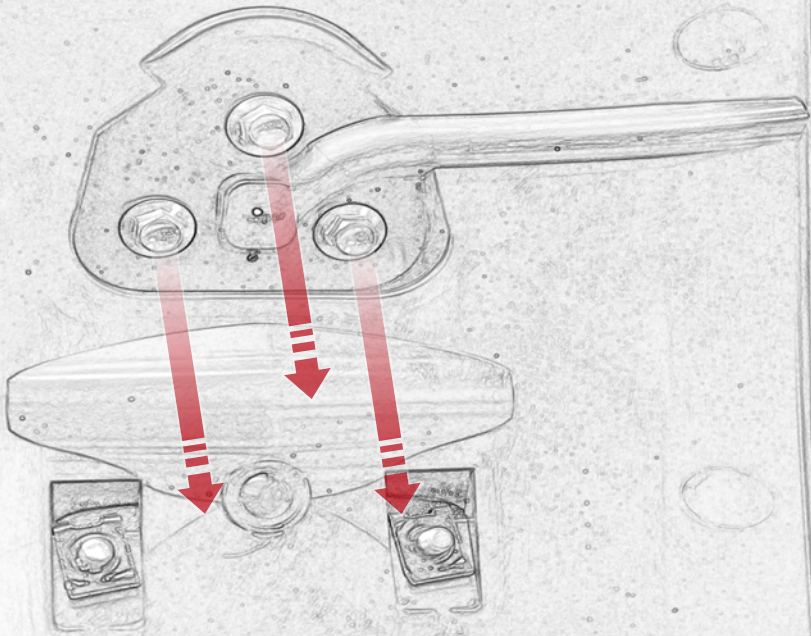

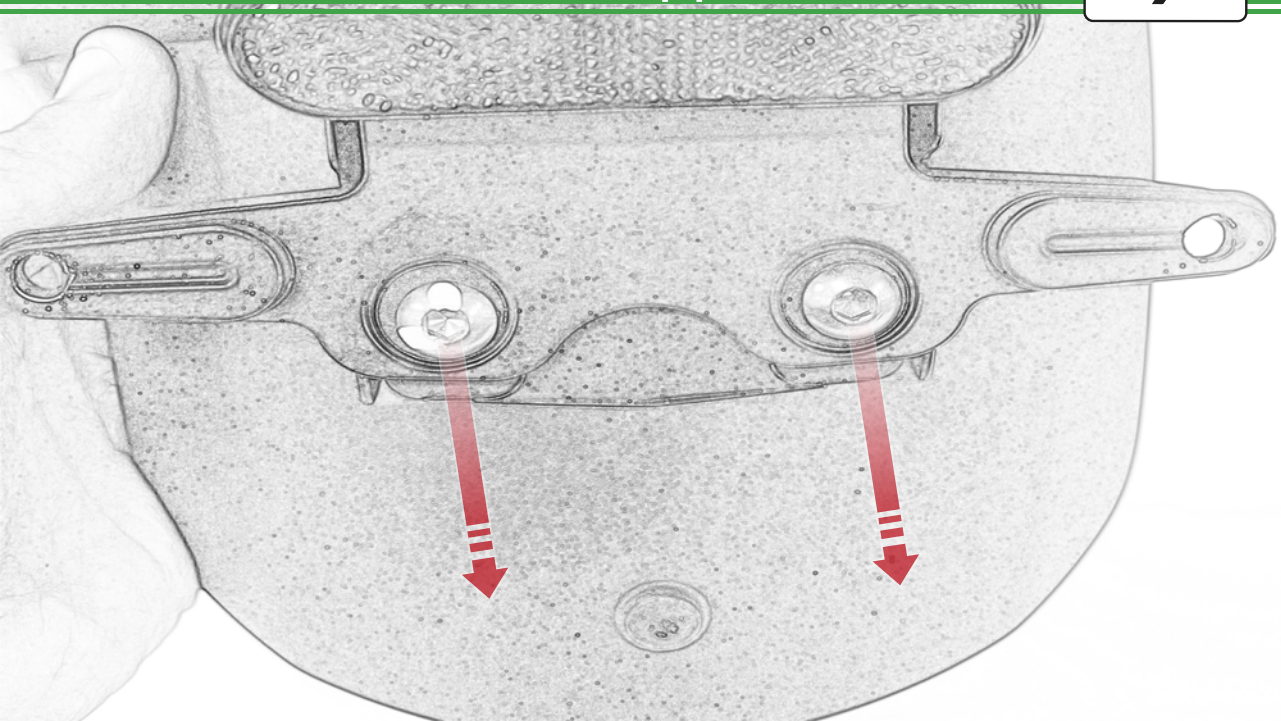

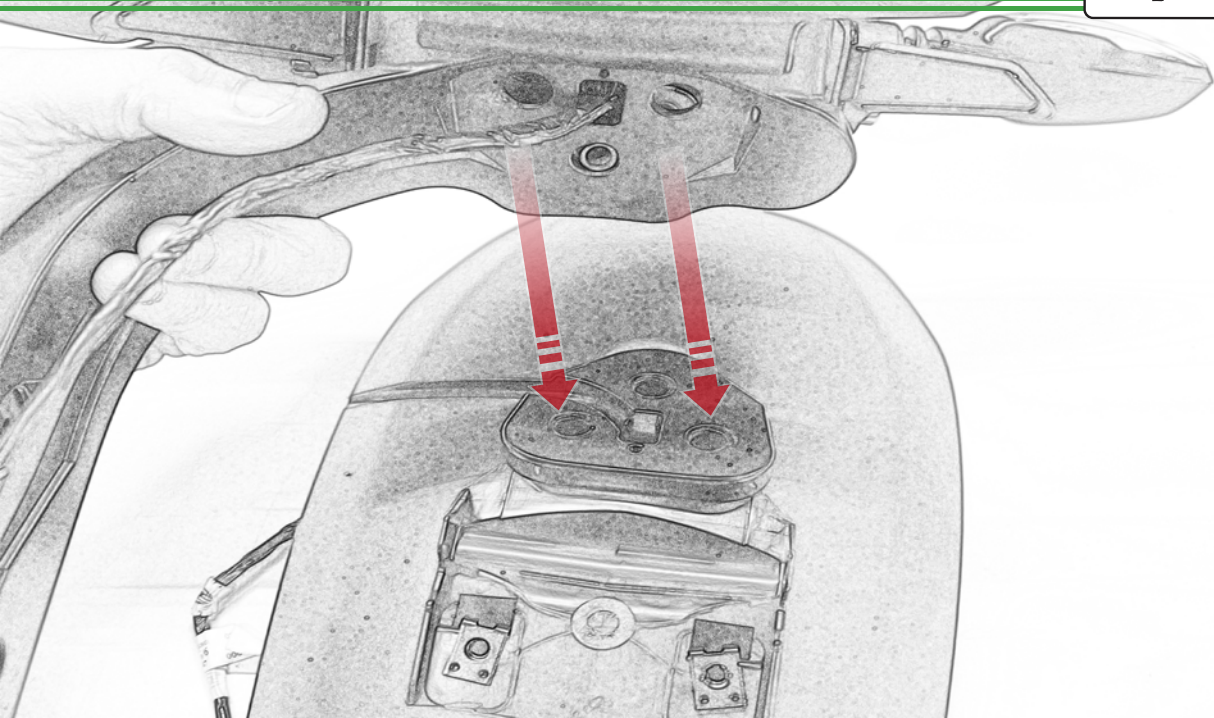

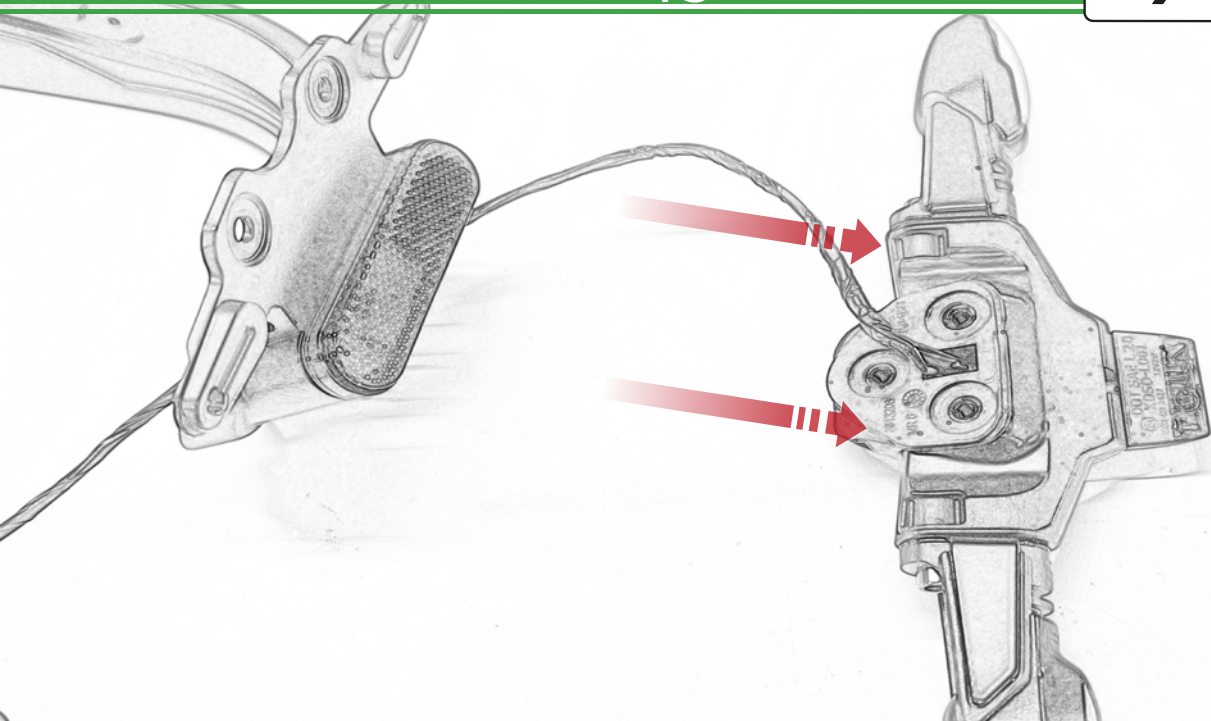

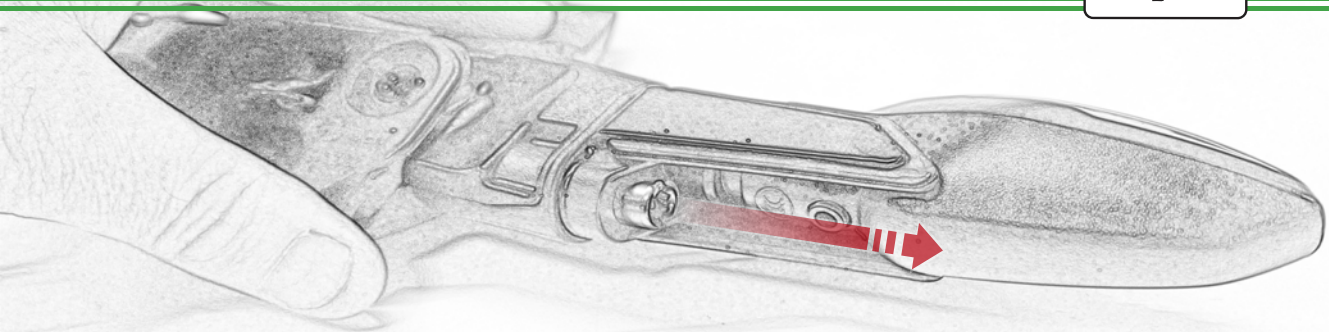

Repeat
Both Sides

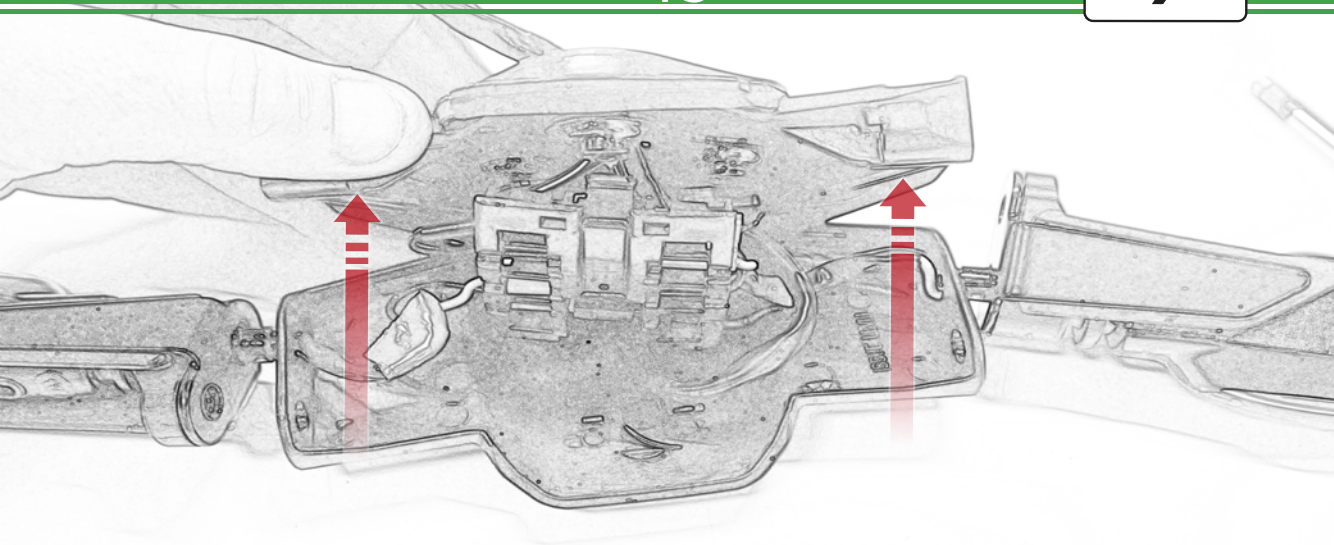

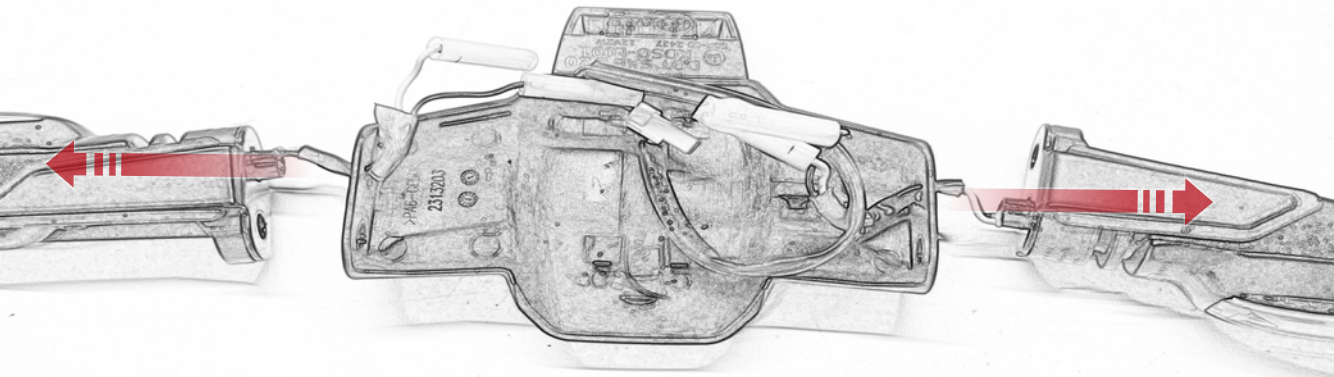

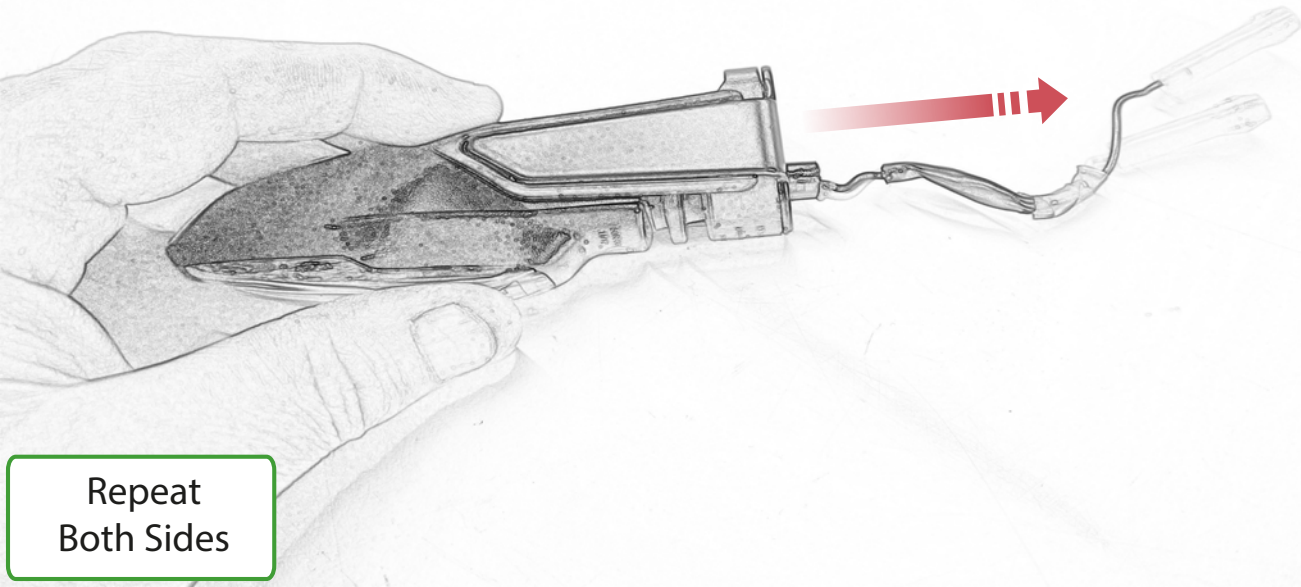

Repeat
Both Sides

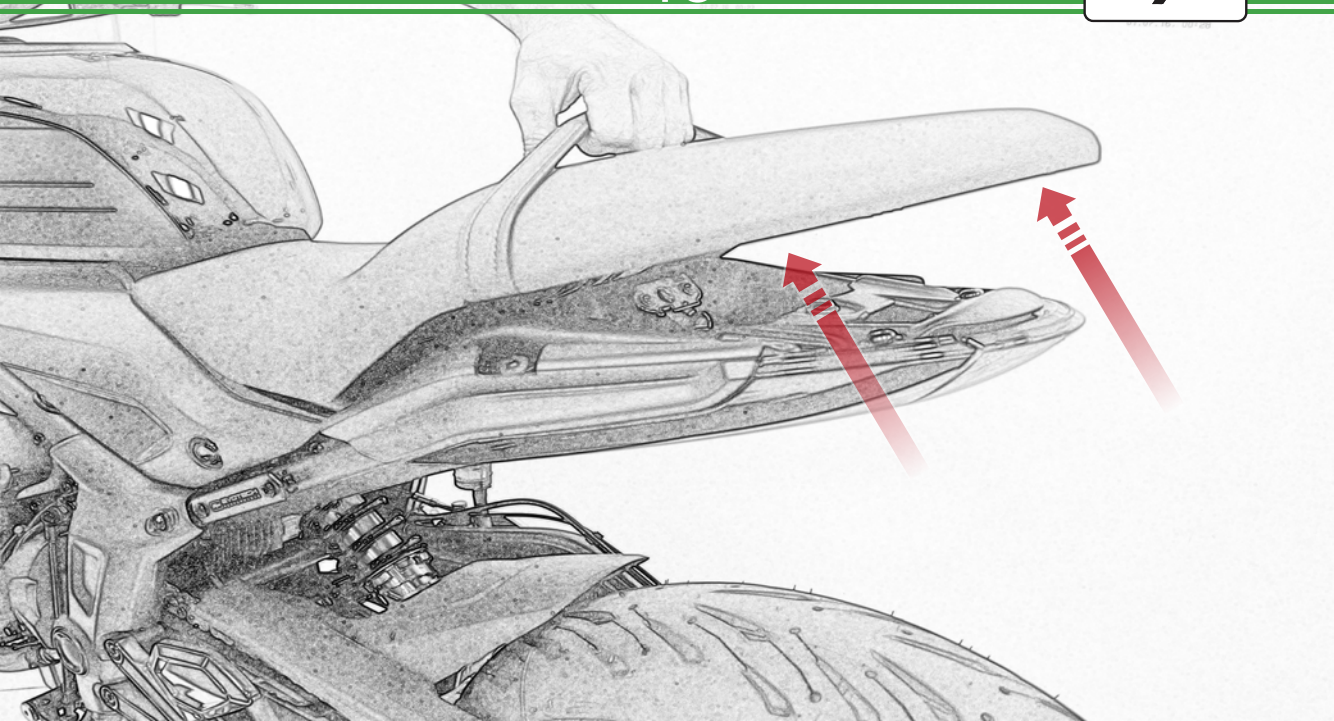

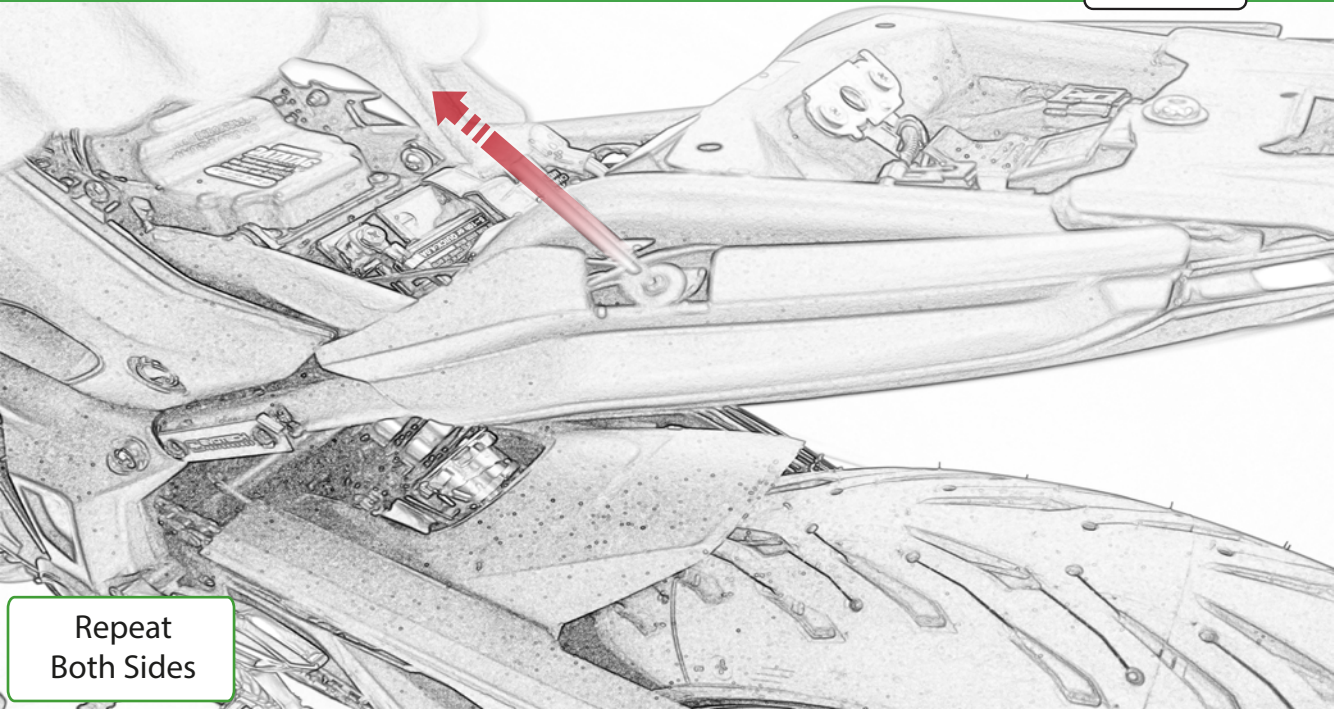

Repeat
Both Sides

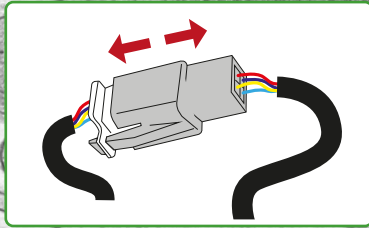
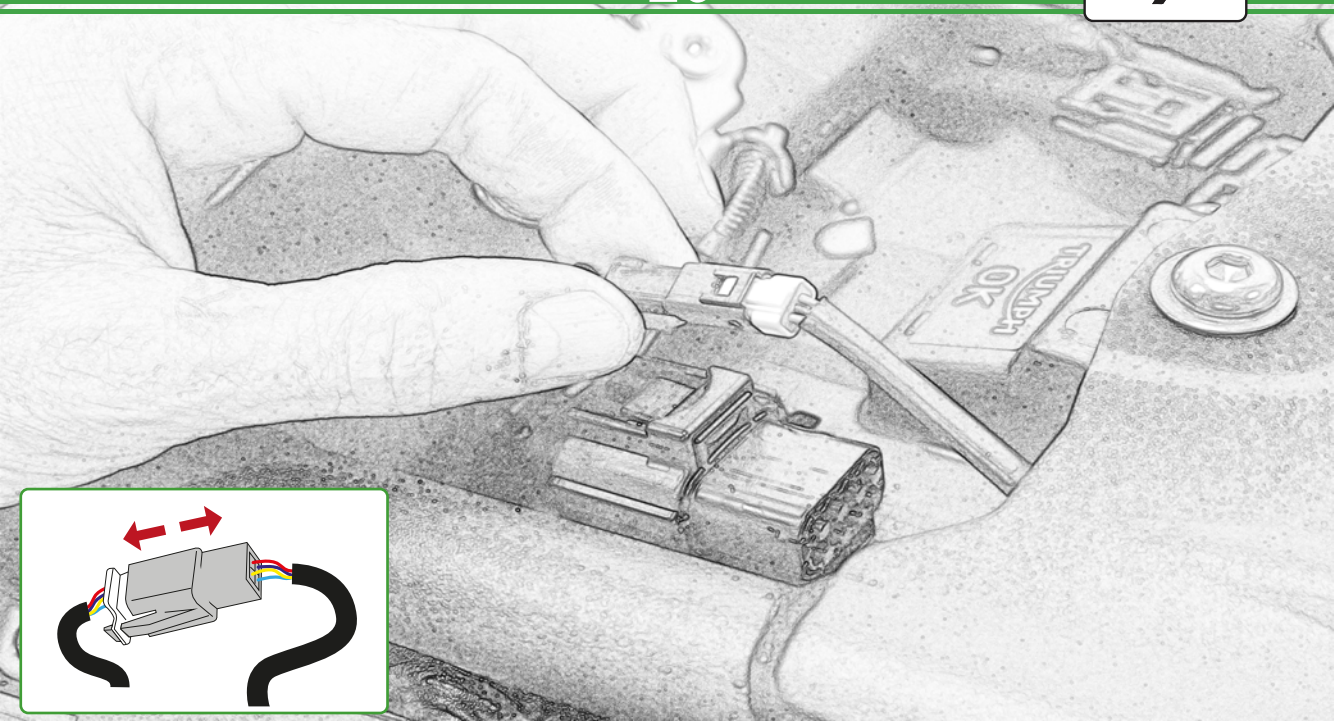

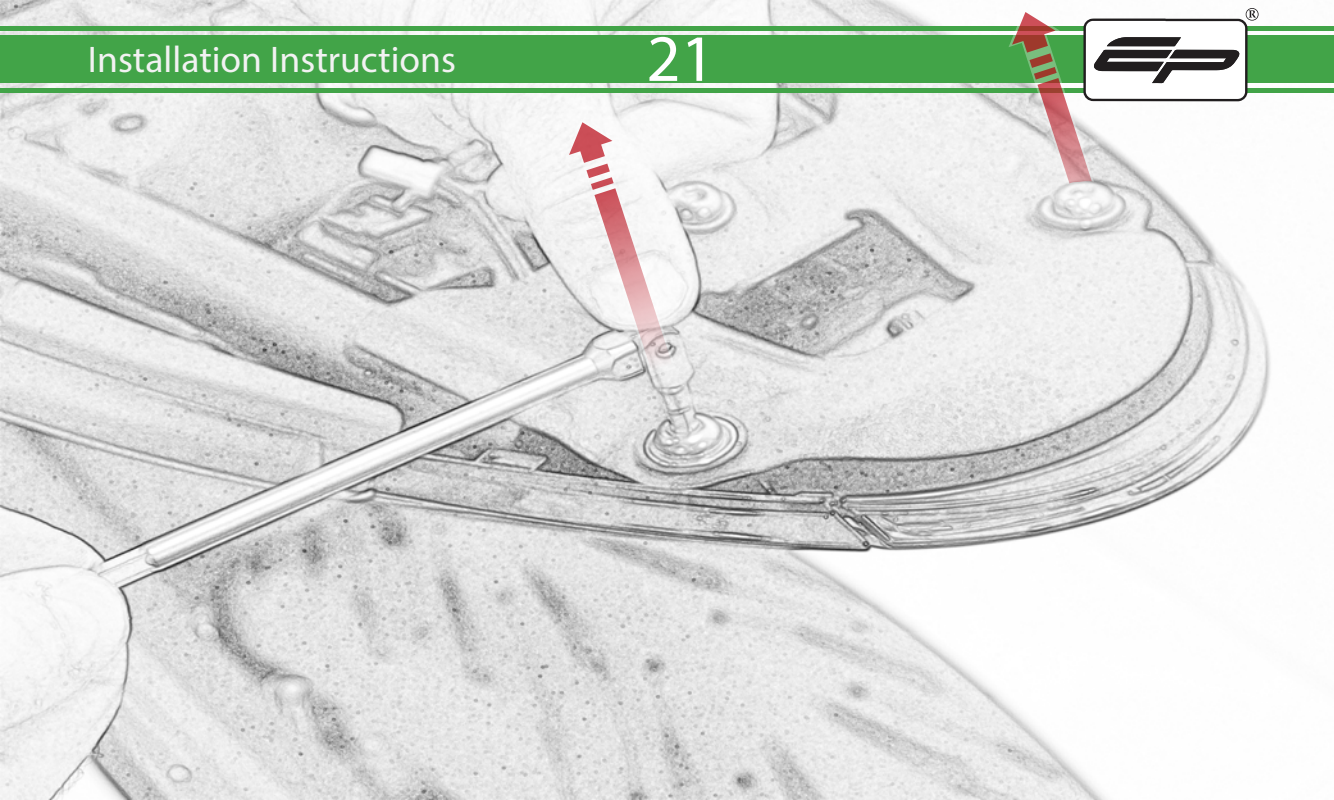

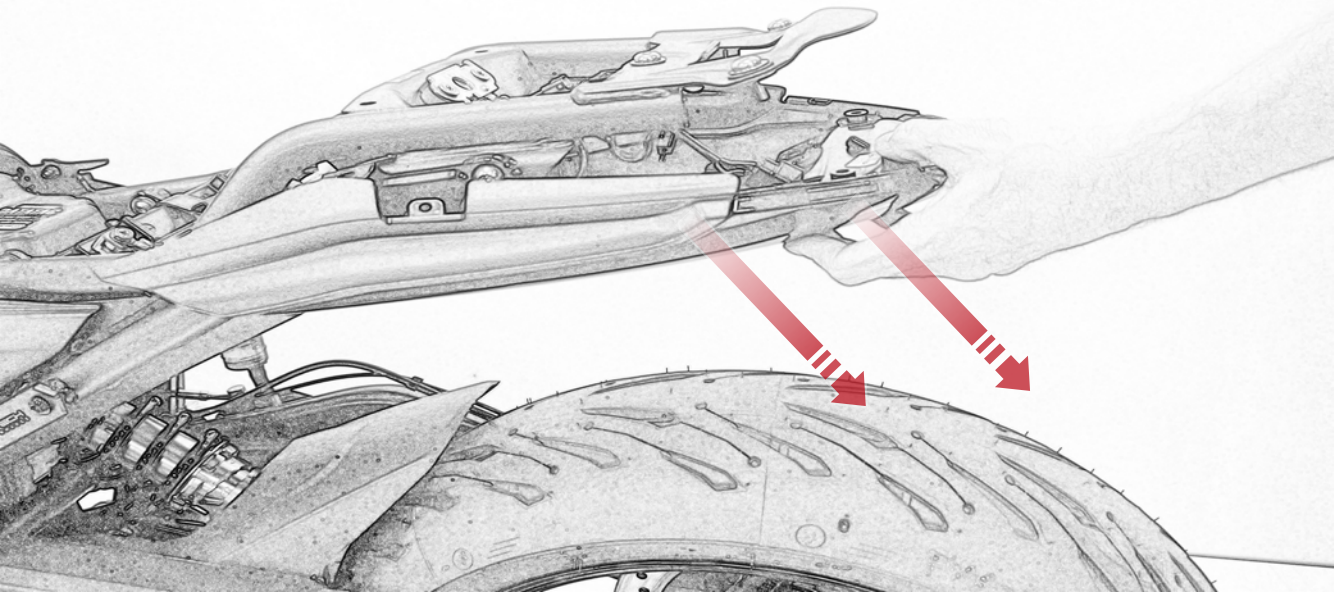

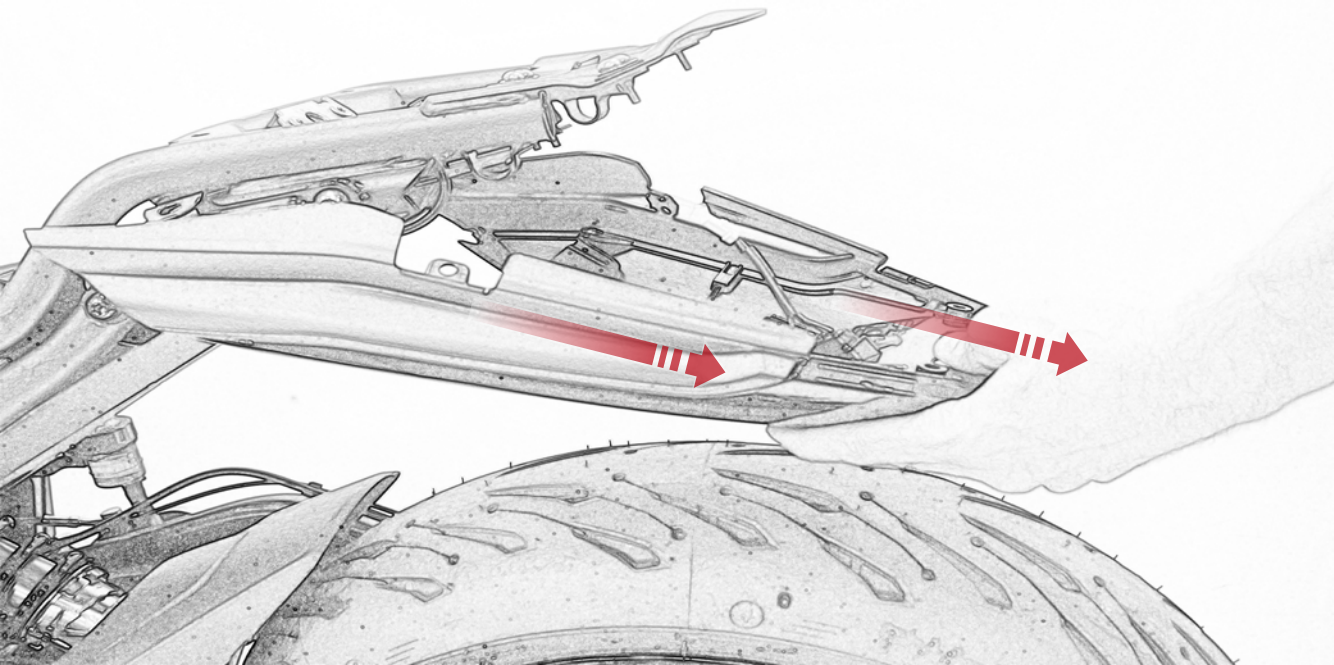



Release
Tab

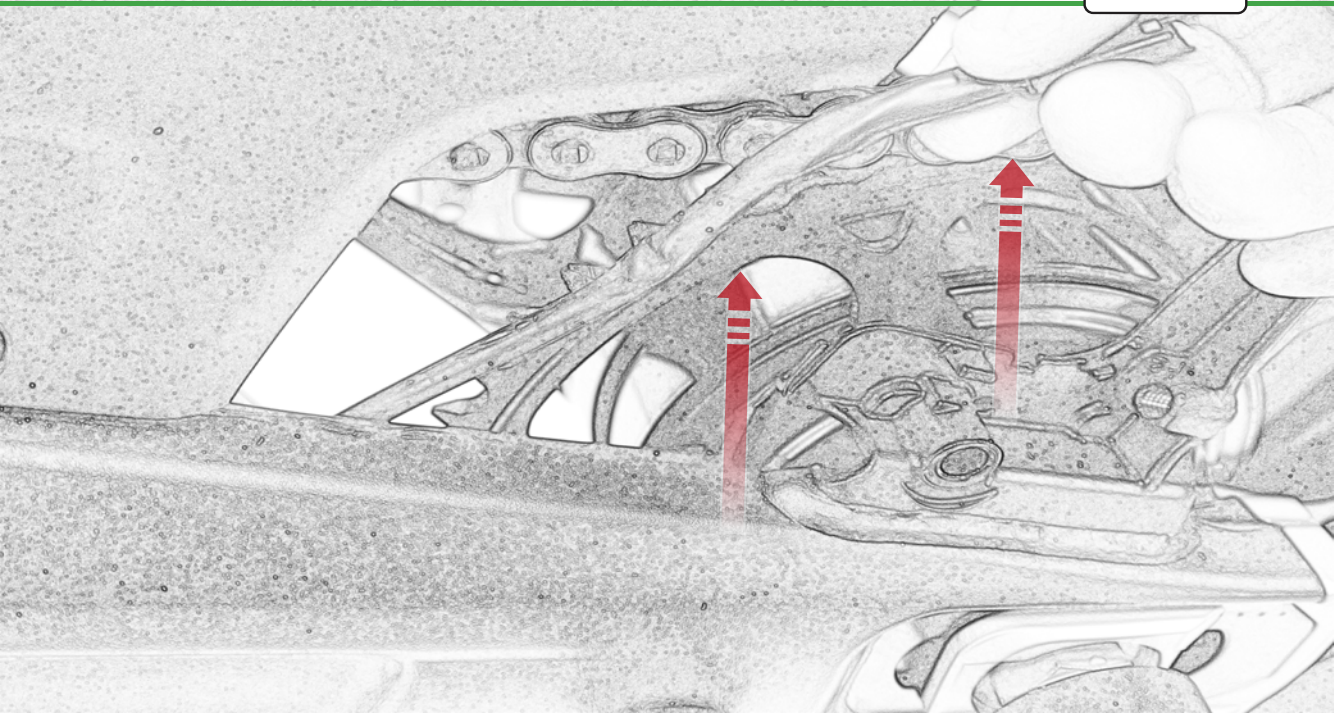

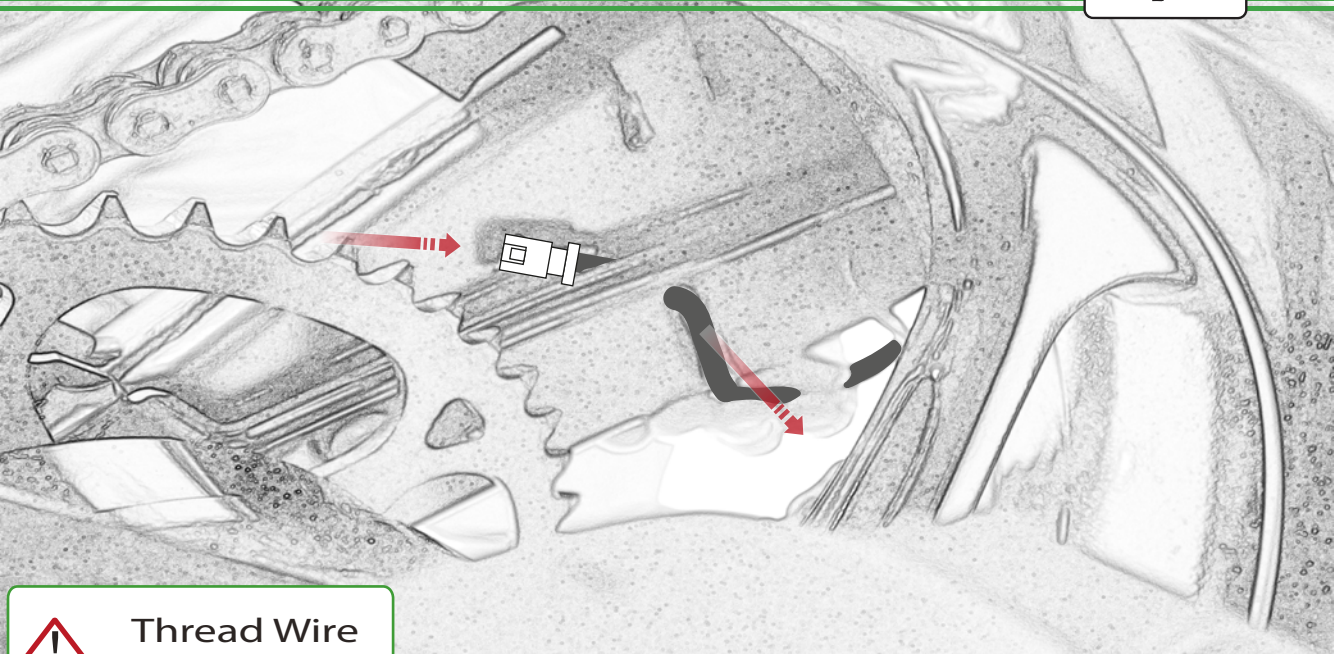

Caution

Thread Wire
Behind Cover

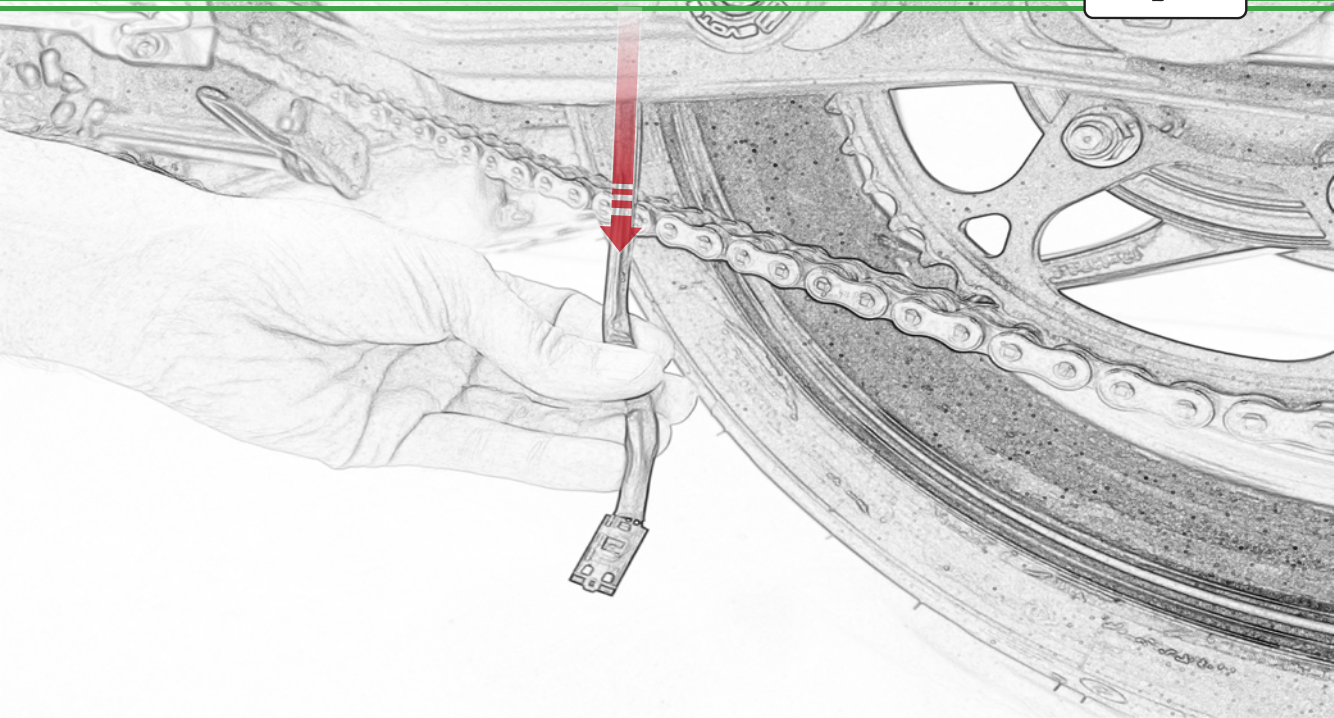

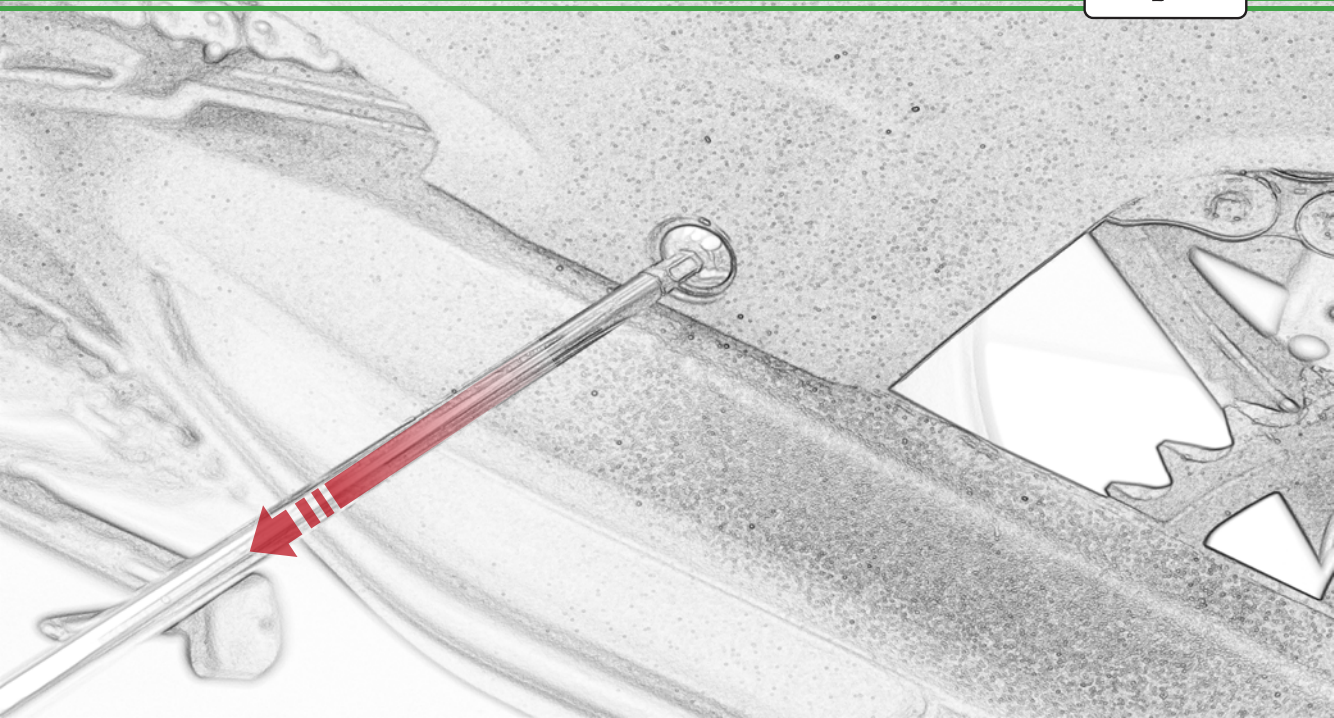

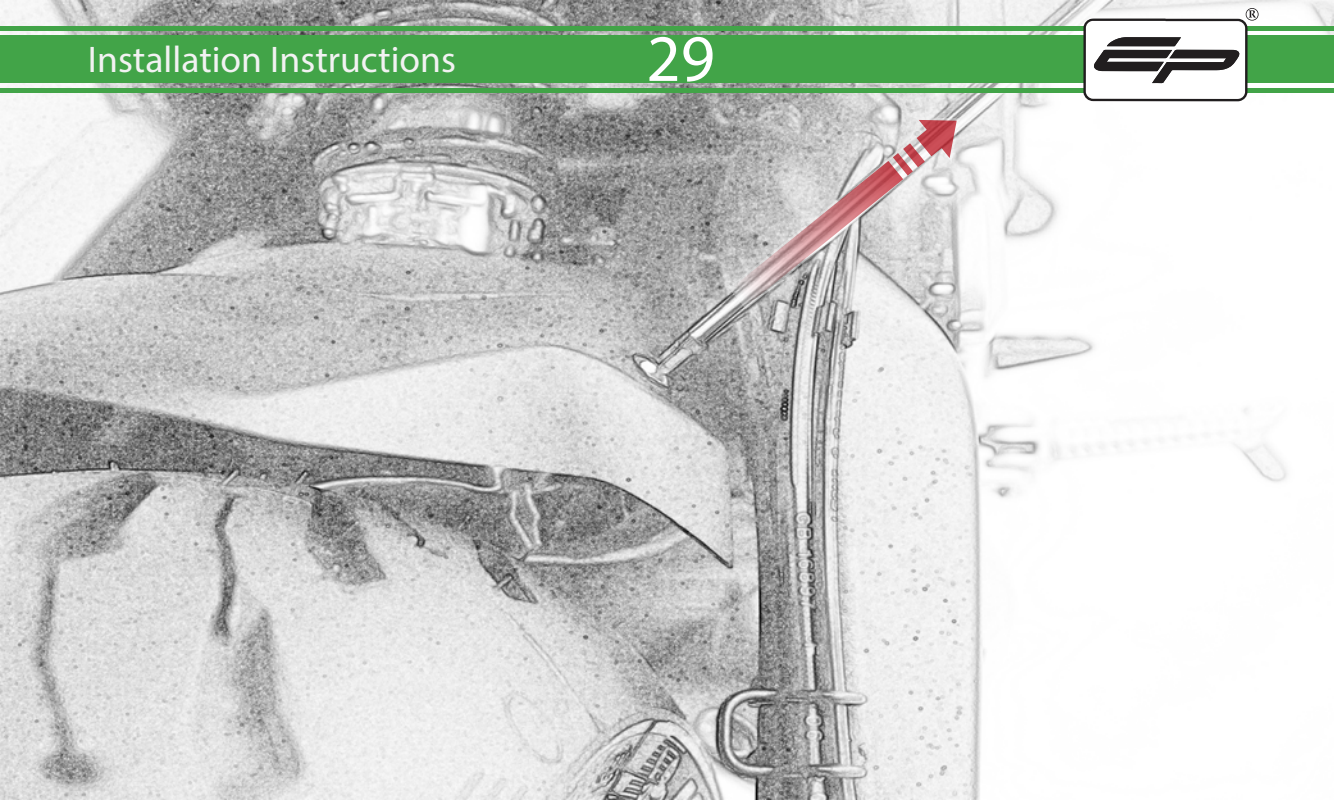

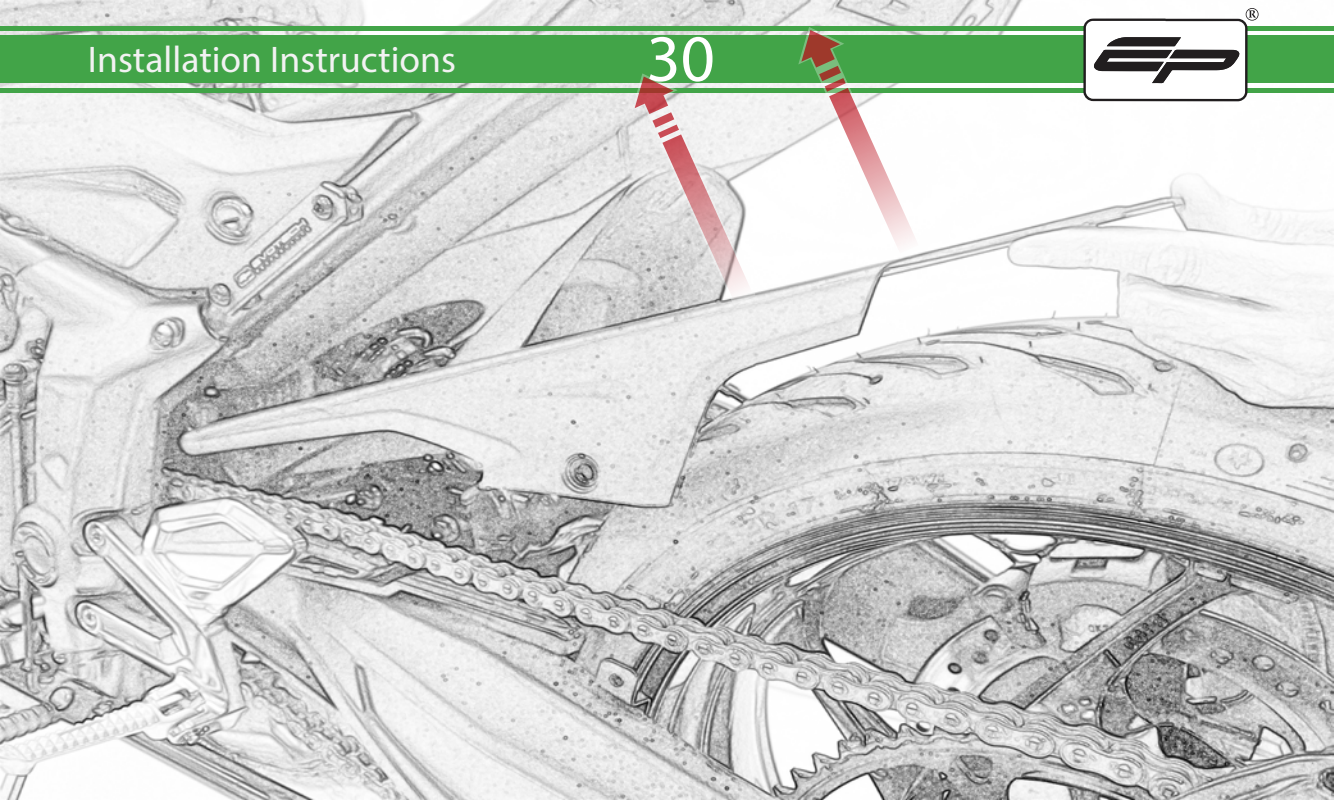

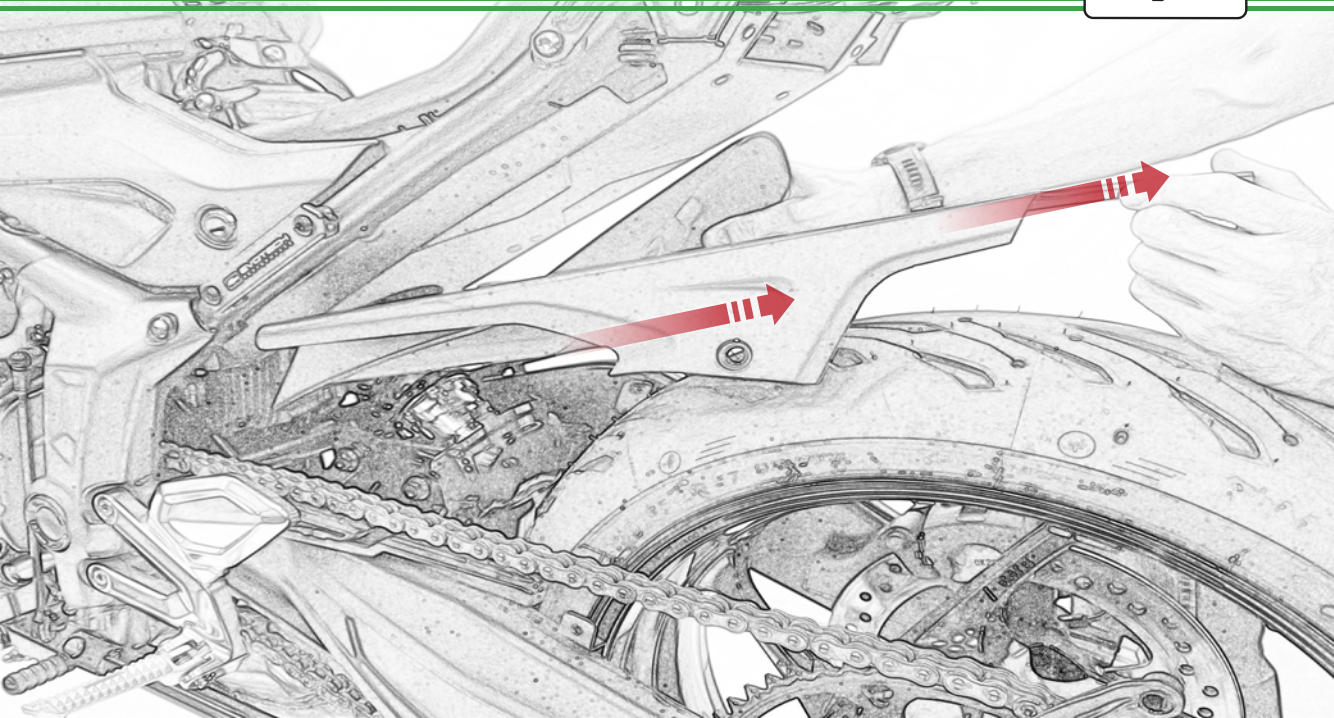

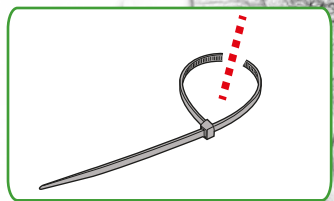
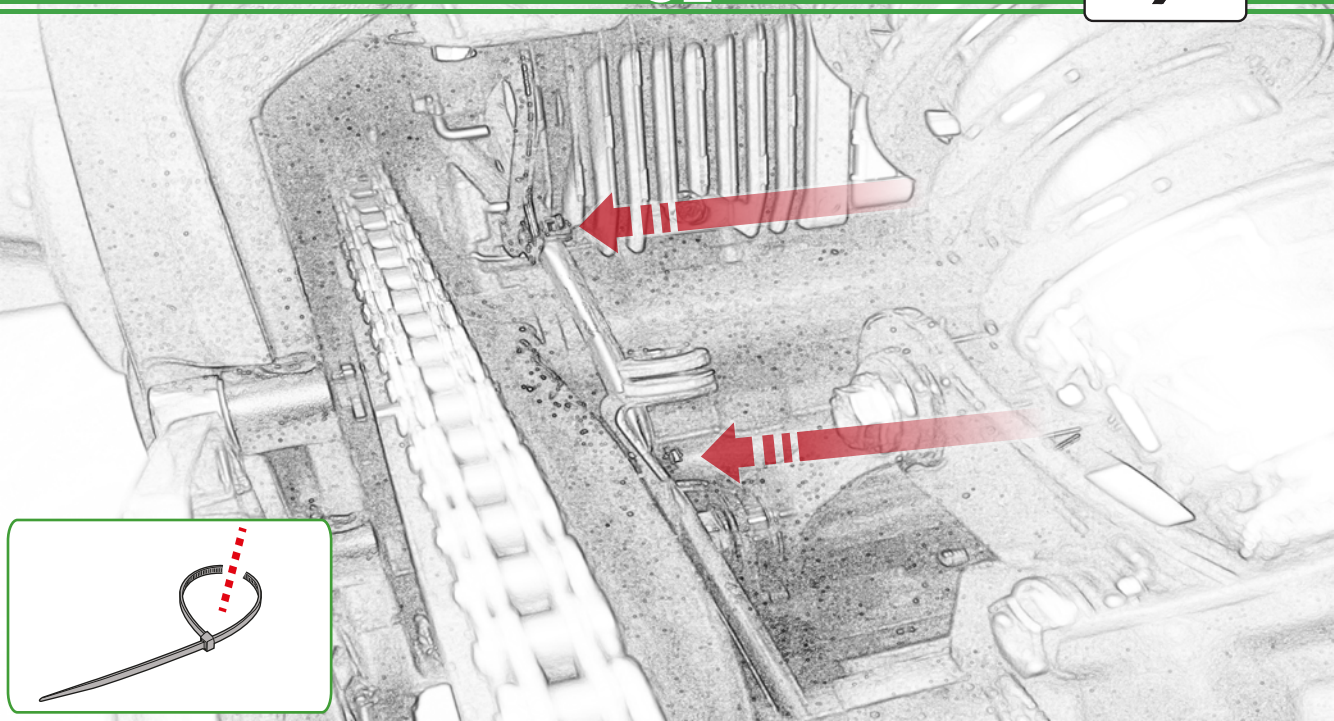

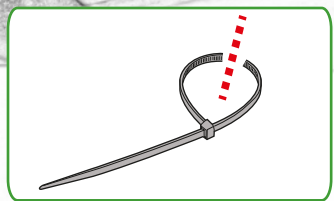
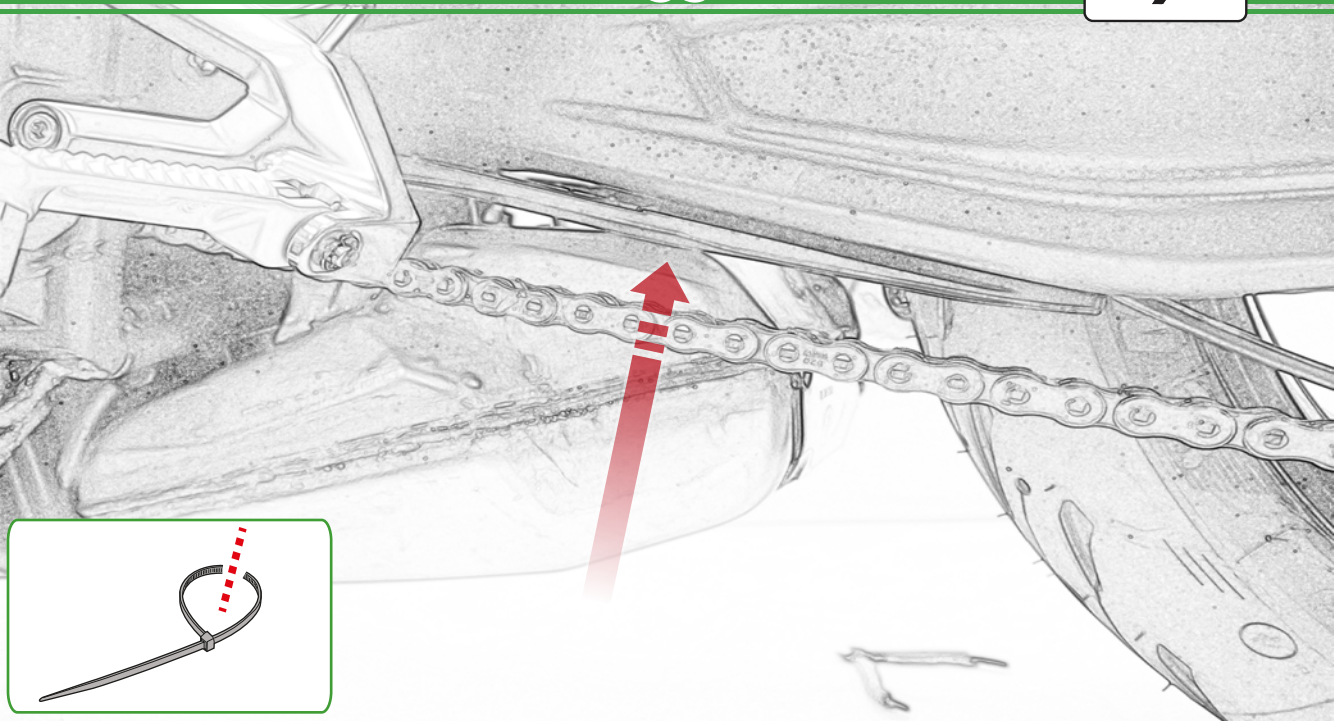

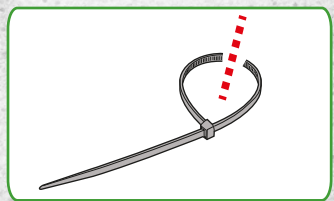
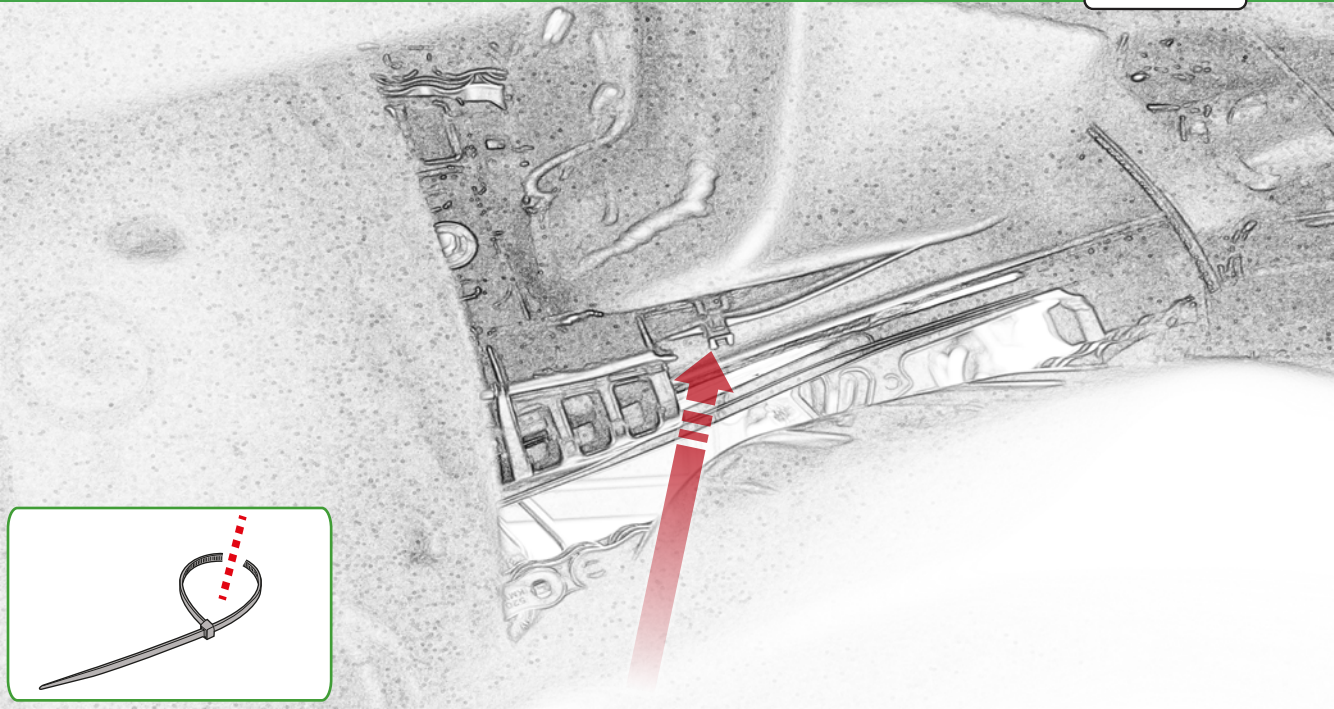

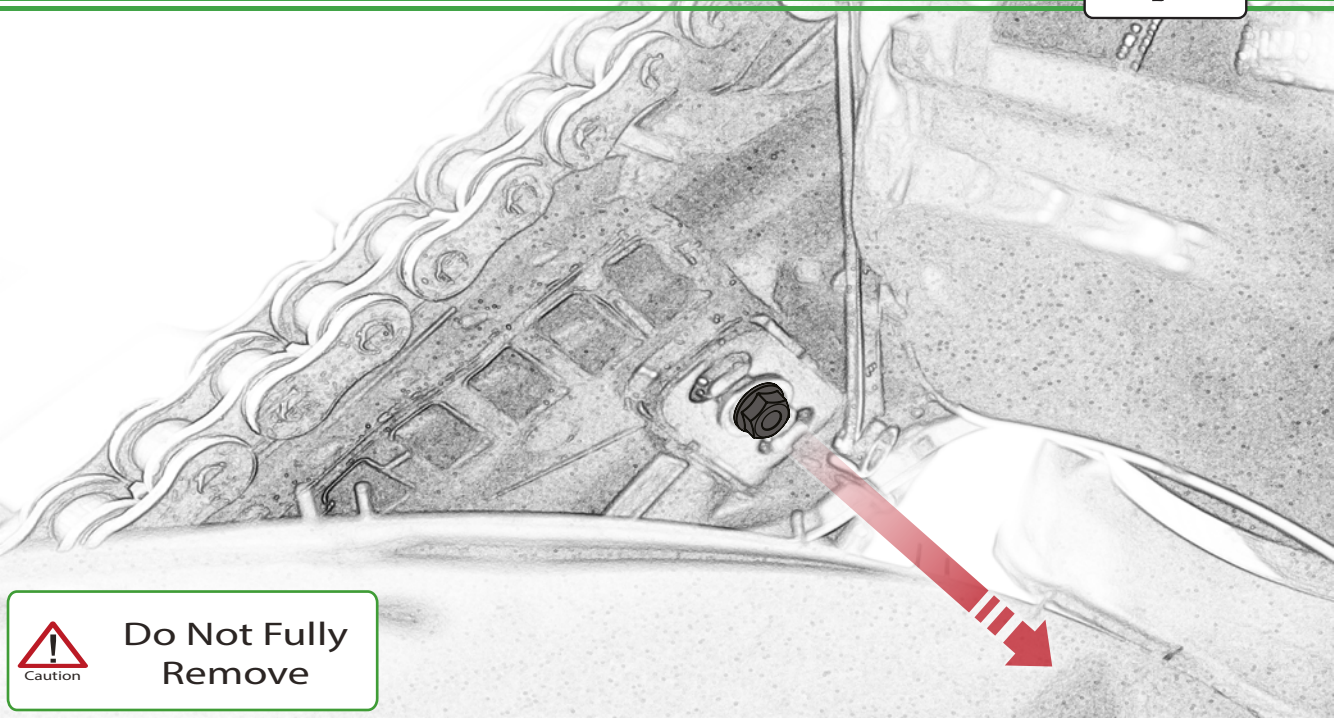

Do Not Fully
Remove

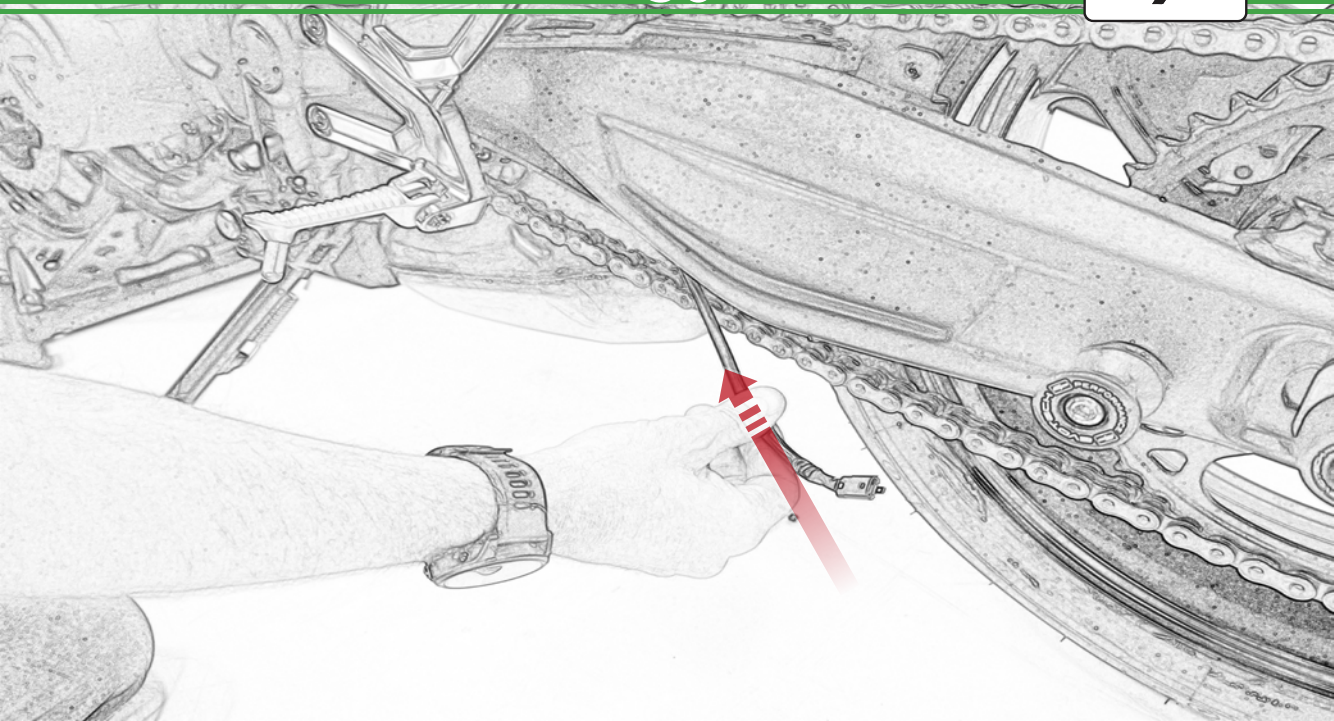

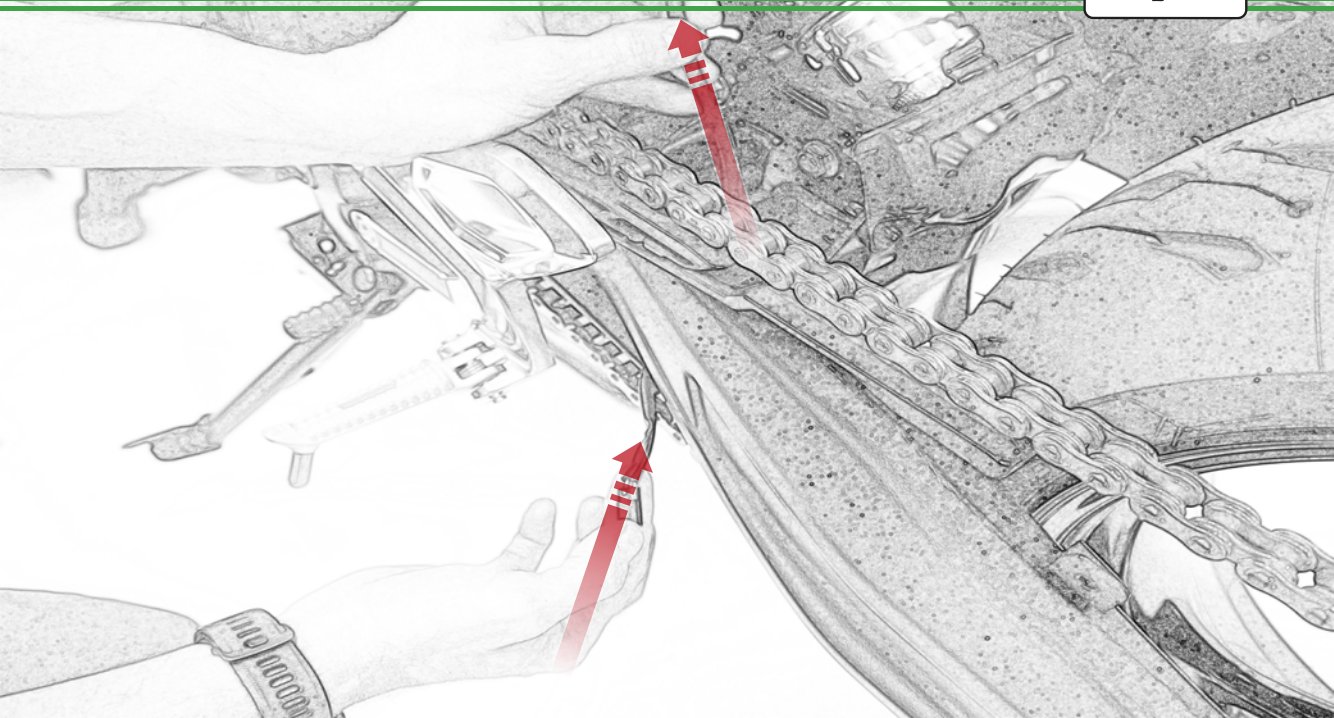

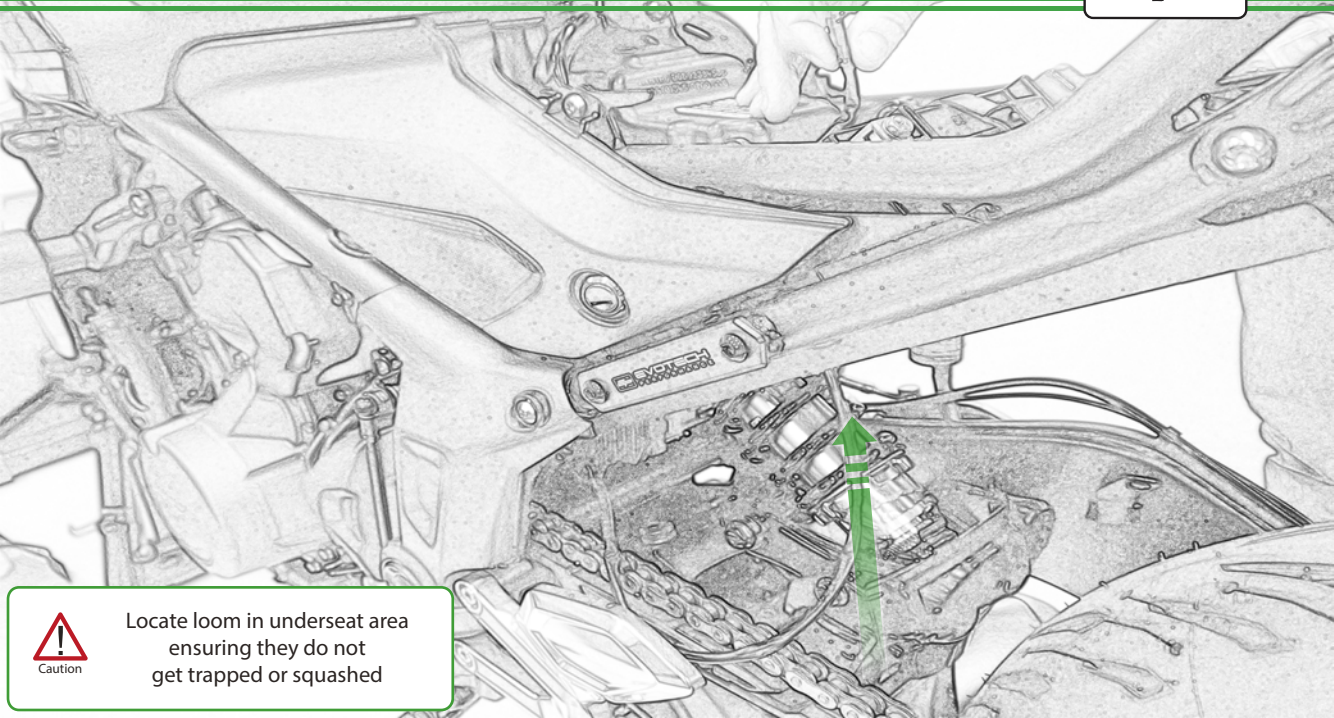

Caution

Locate loom in underseat area
ensuring they do not
get trapped or squashed

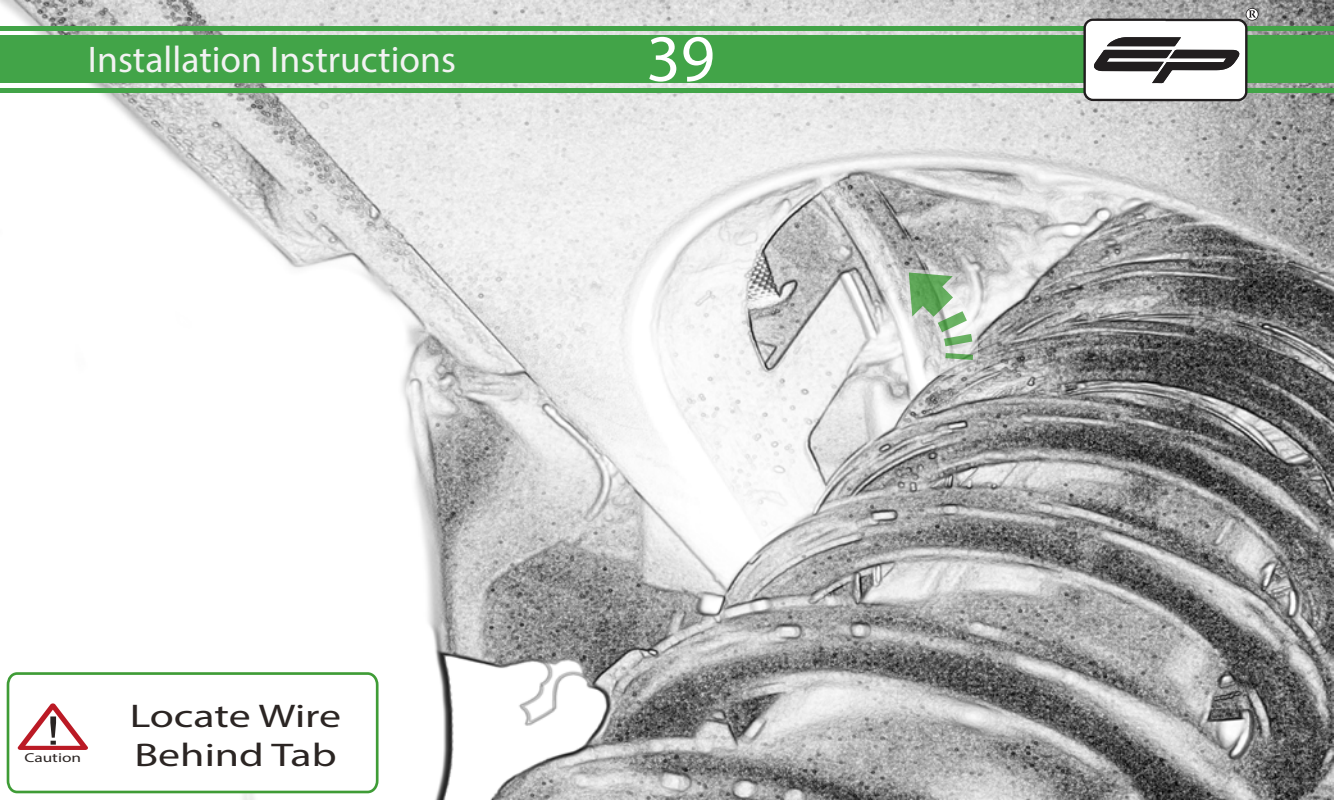

Caution

Locate Wire
Behind Tab



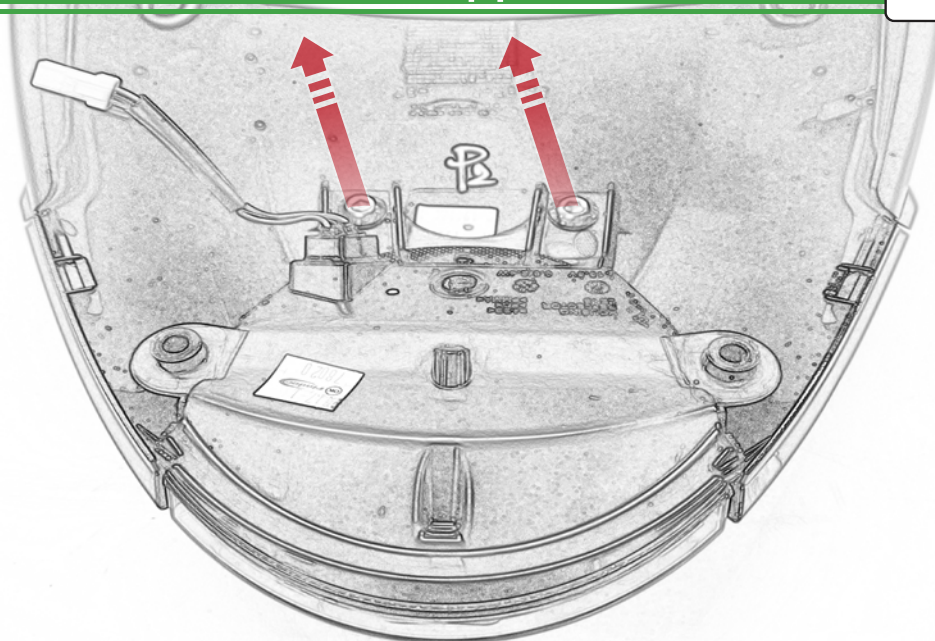



A

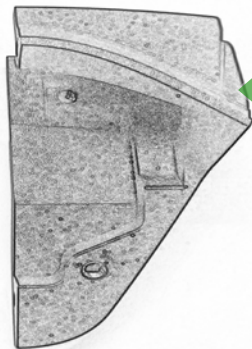
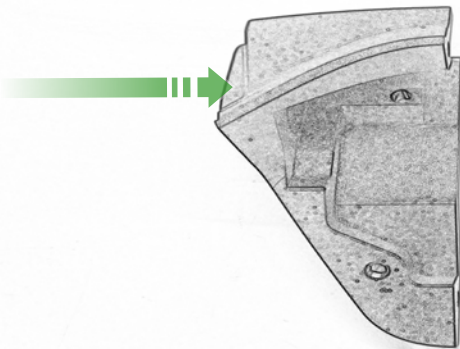
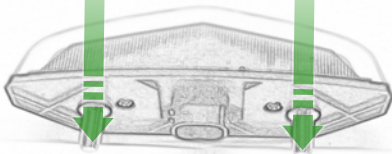

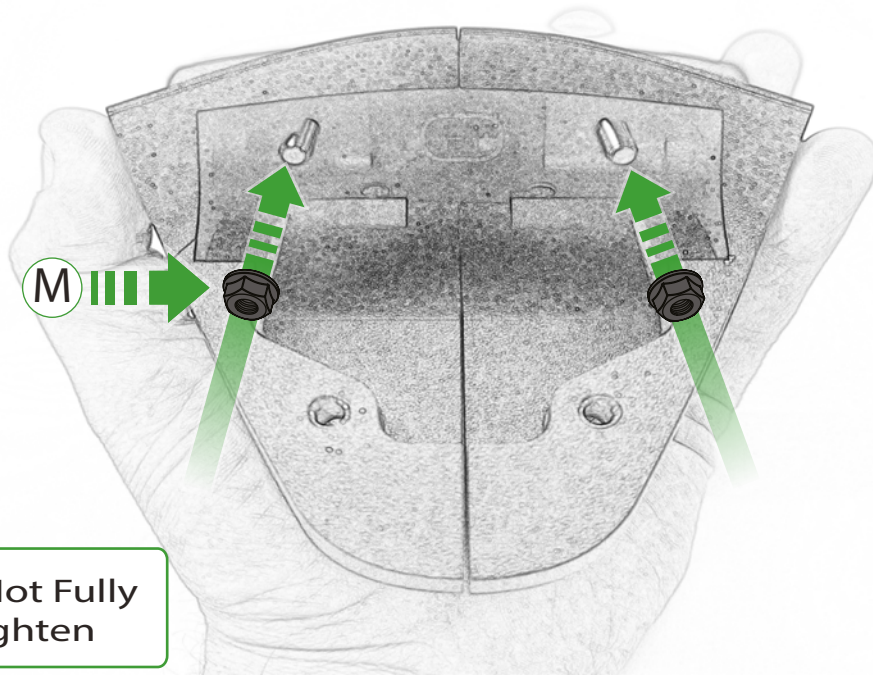

Caution

Do Not Fully Tighten

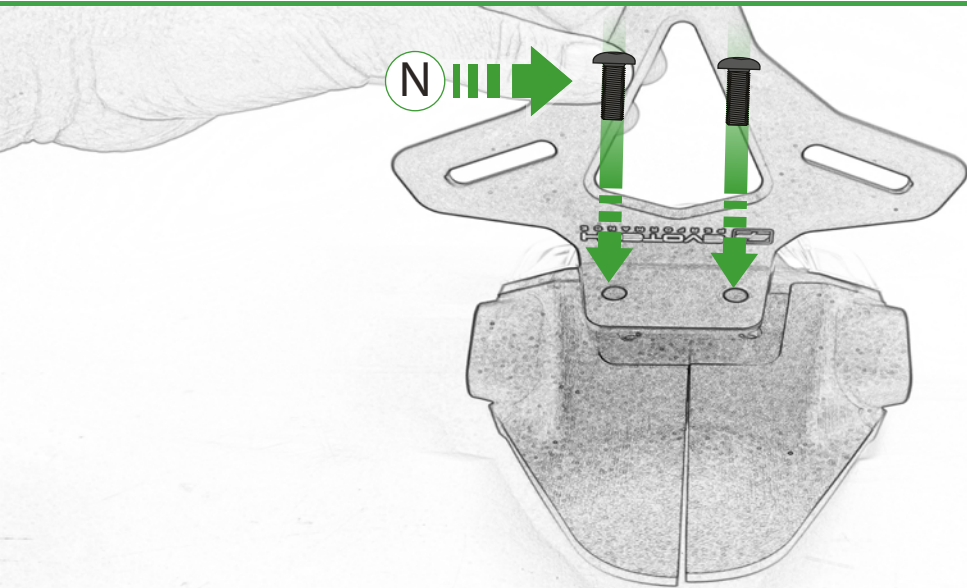

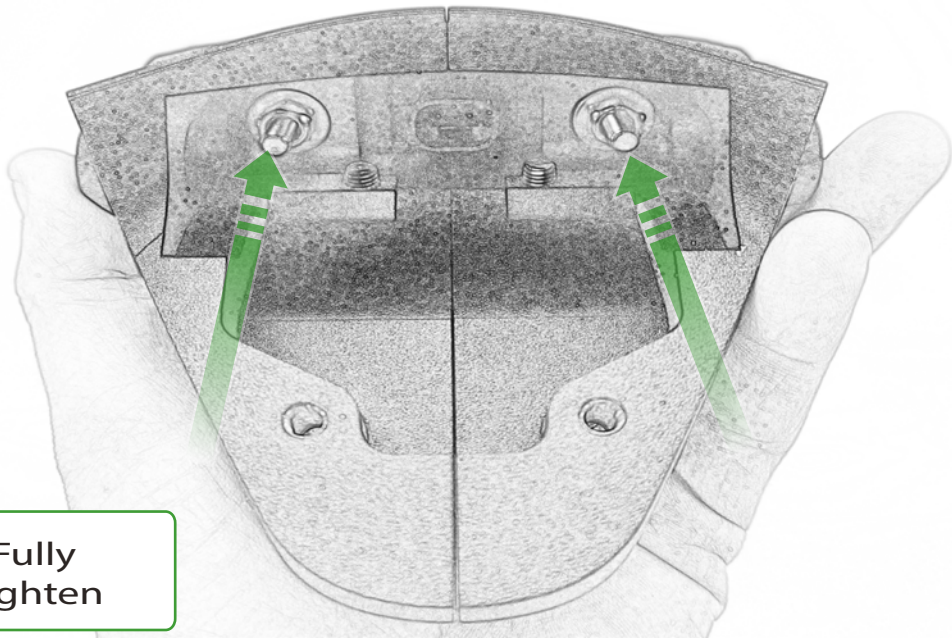

Caution

Fully
Tighten

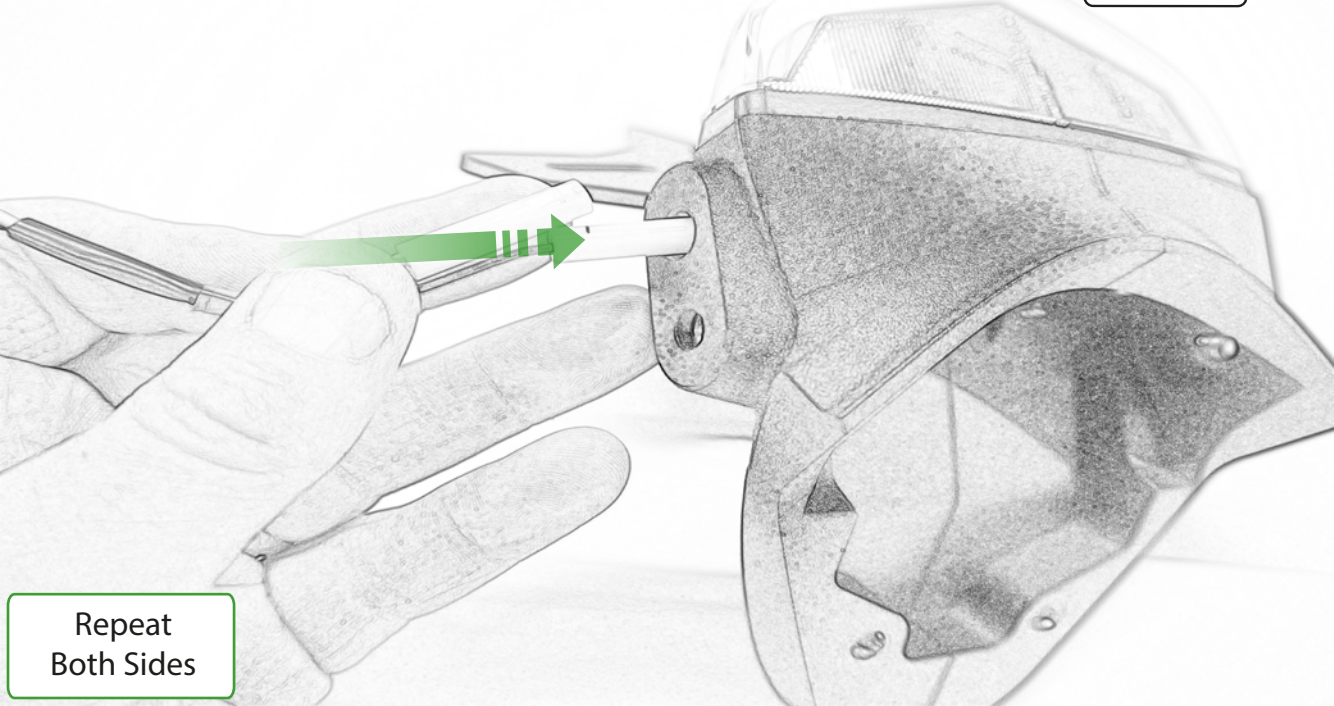

Repeat
Both Sides

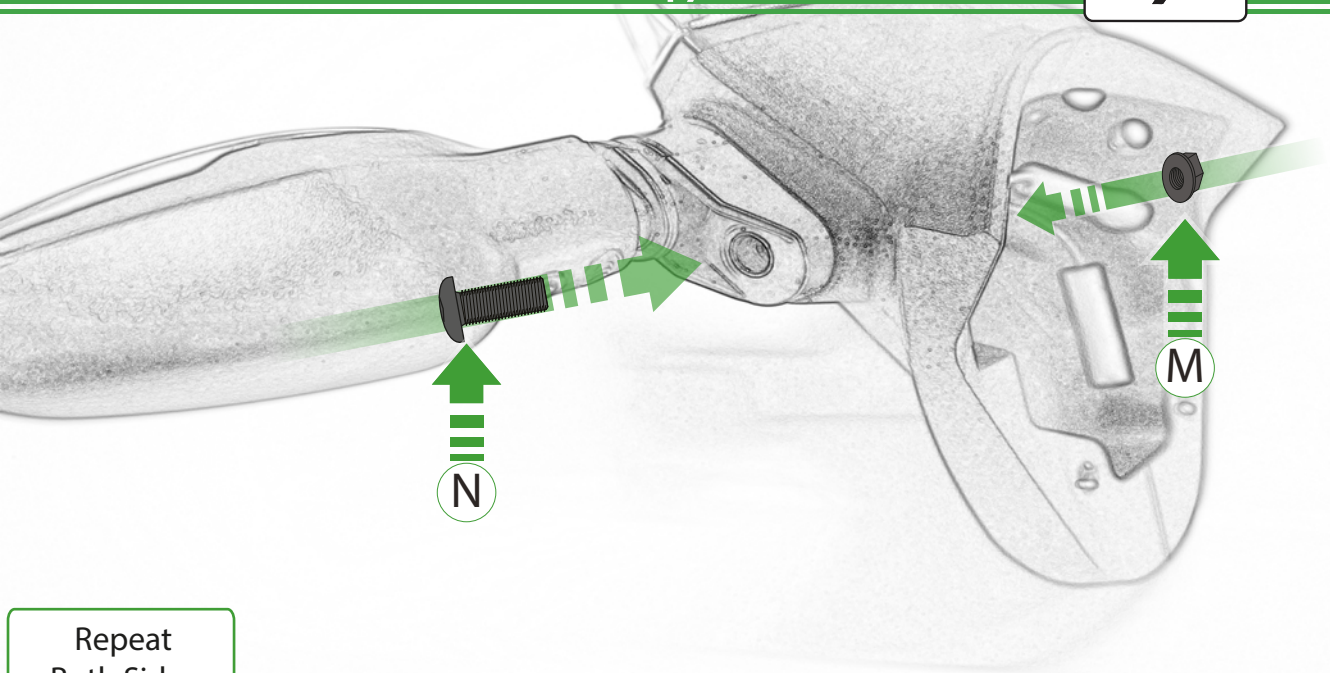

N

M

Repeat
Both Sides

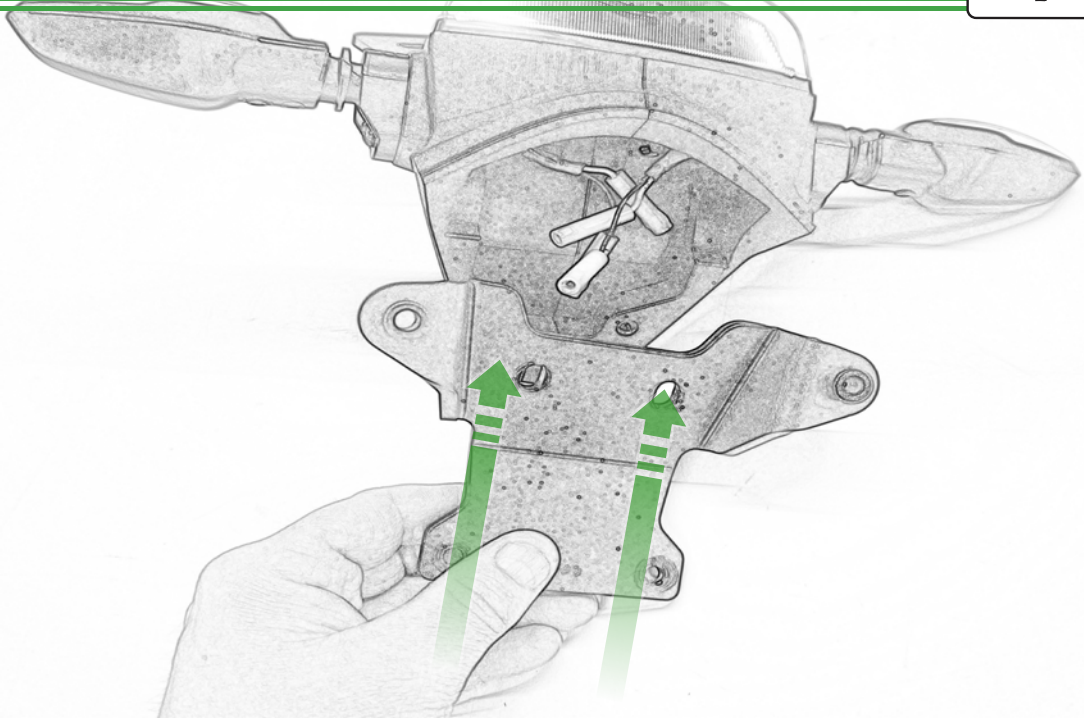



N

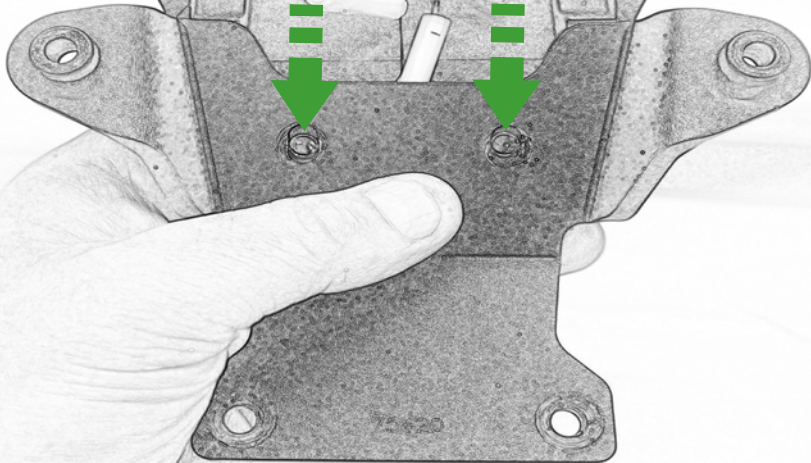
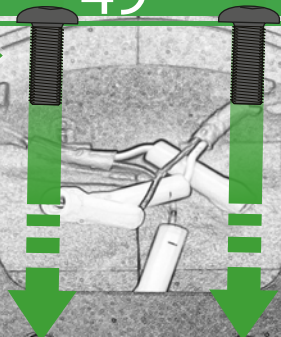

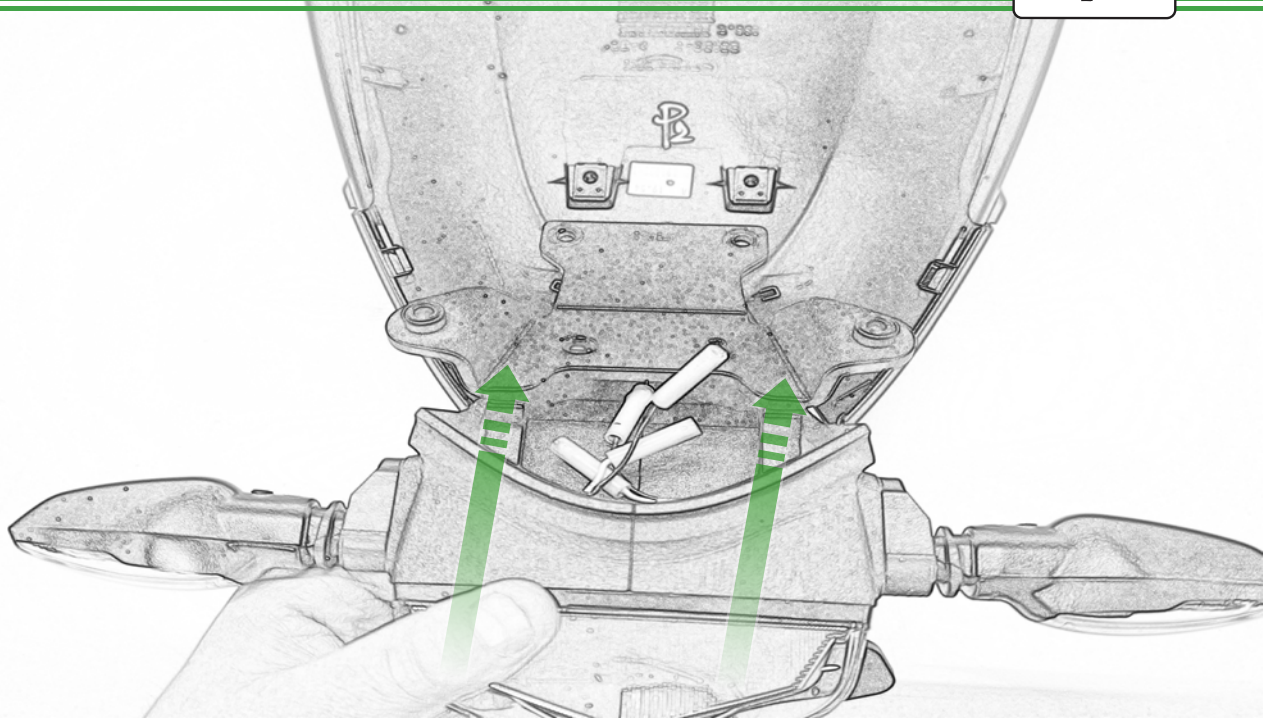

N

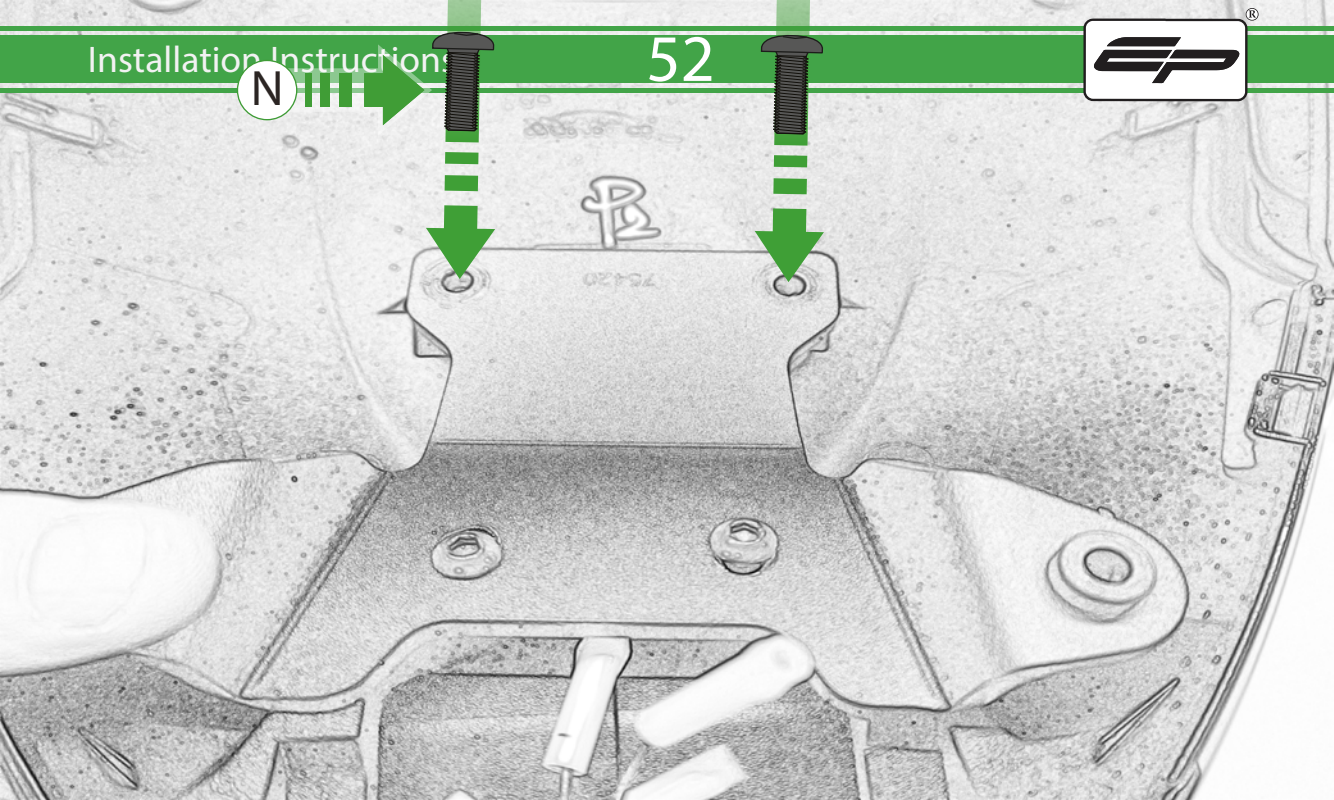

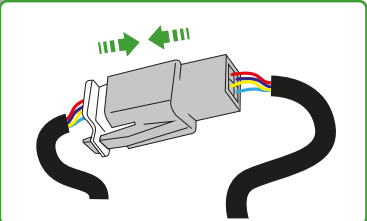
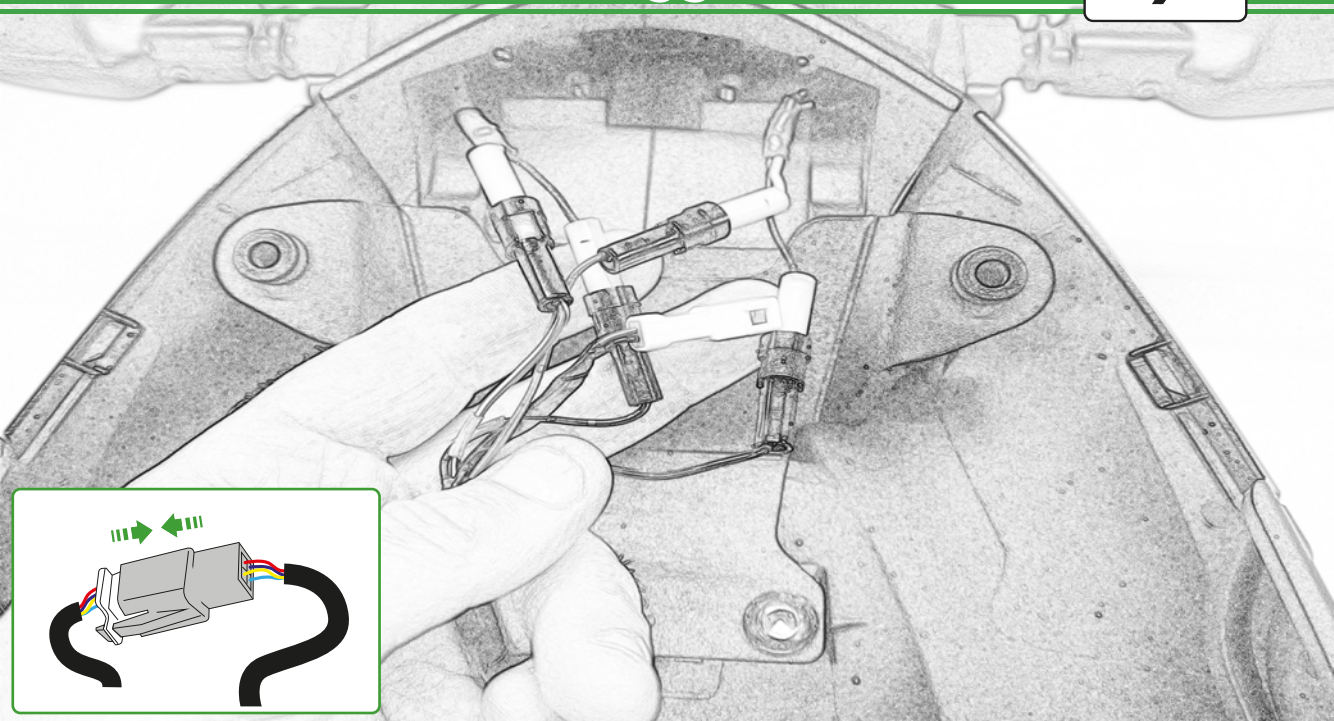

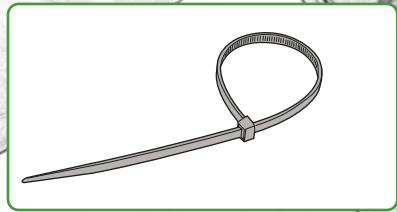
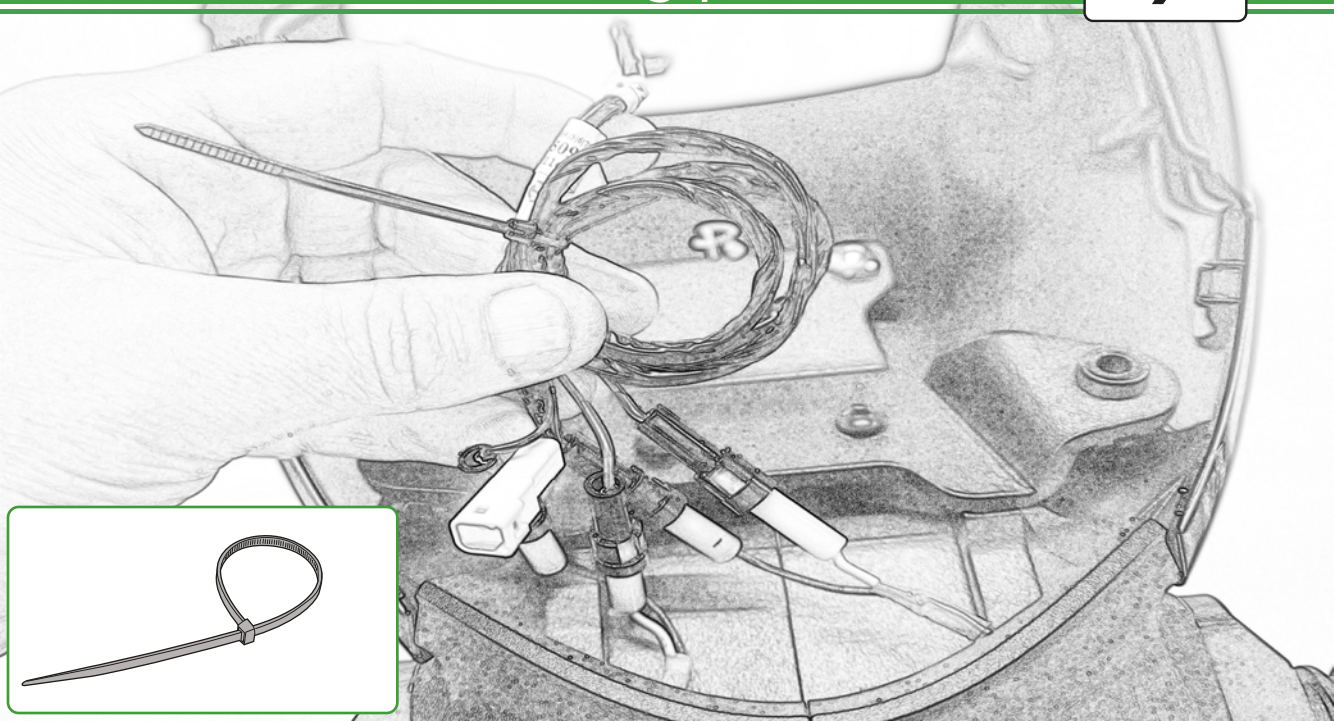

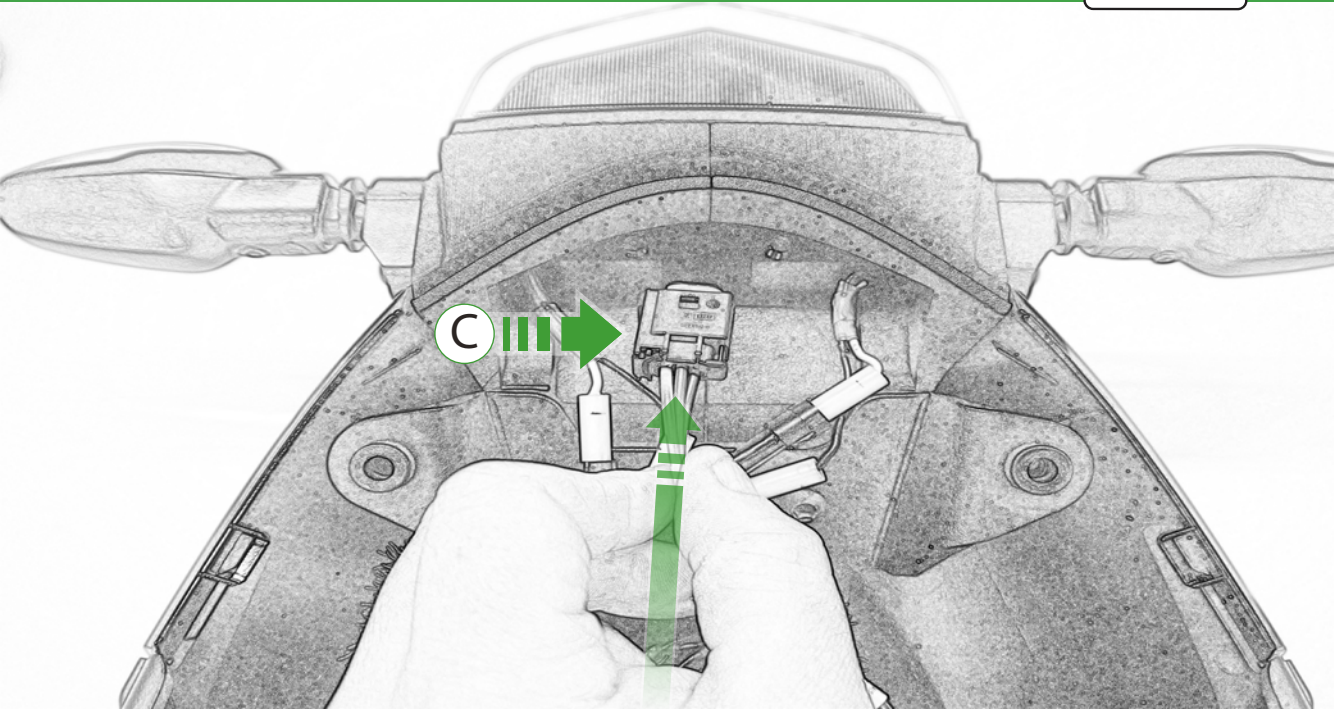

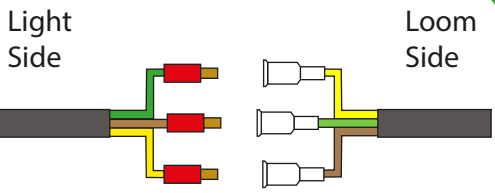
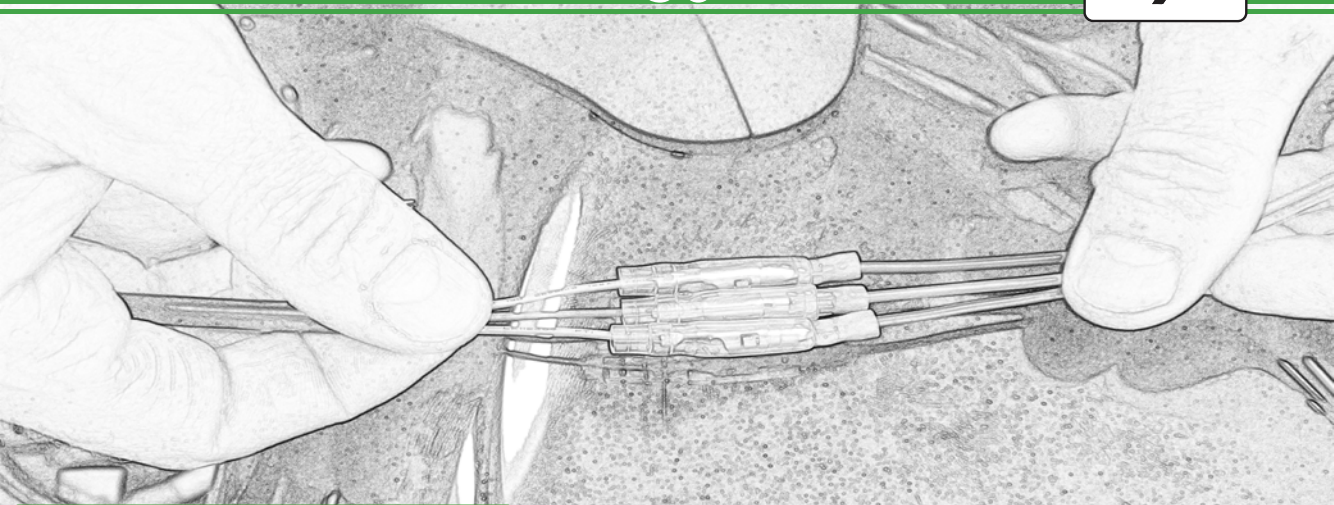

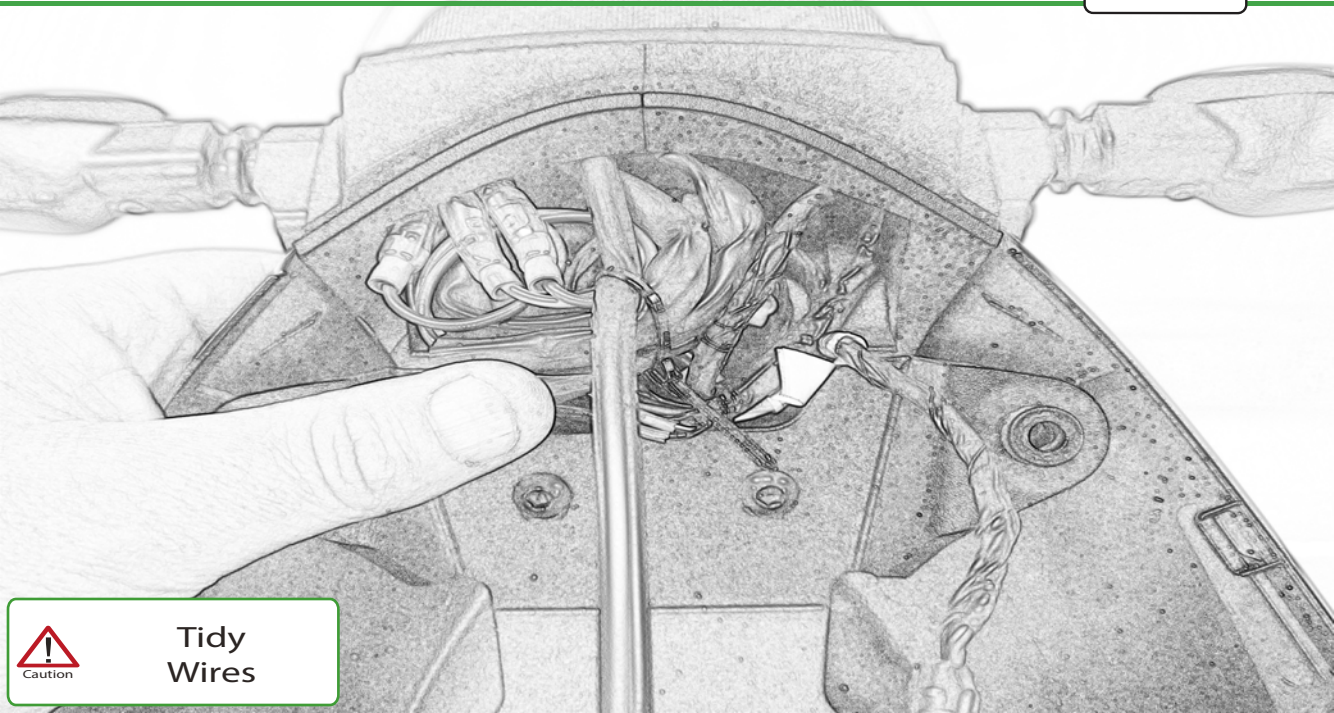

Caution

Tidy
Wires

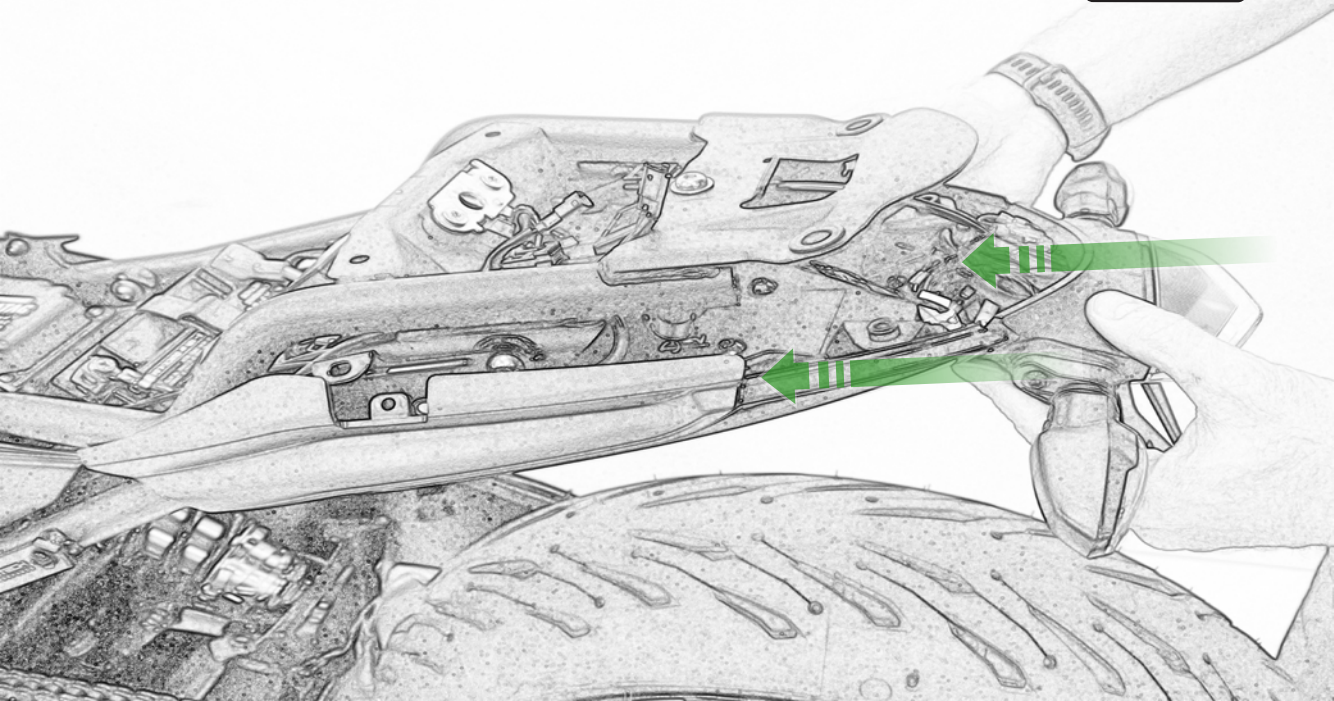

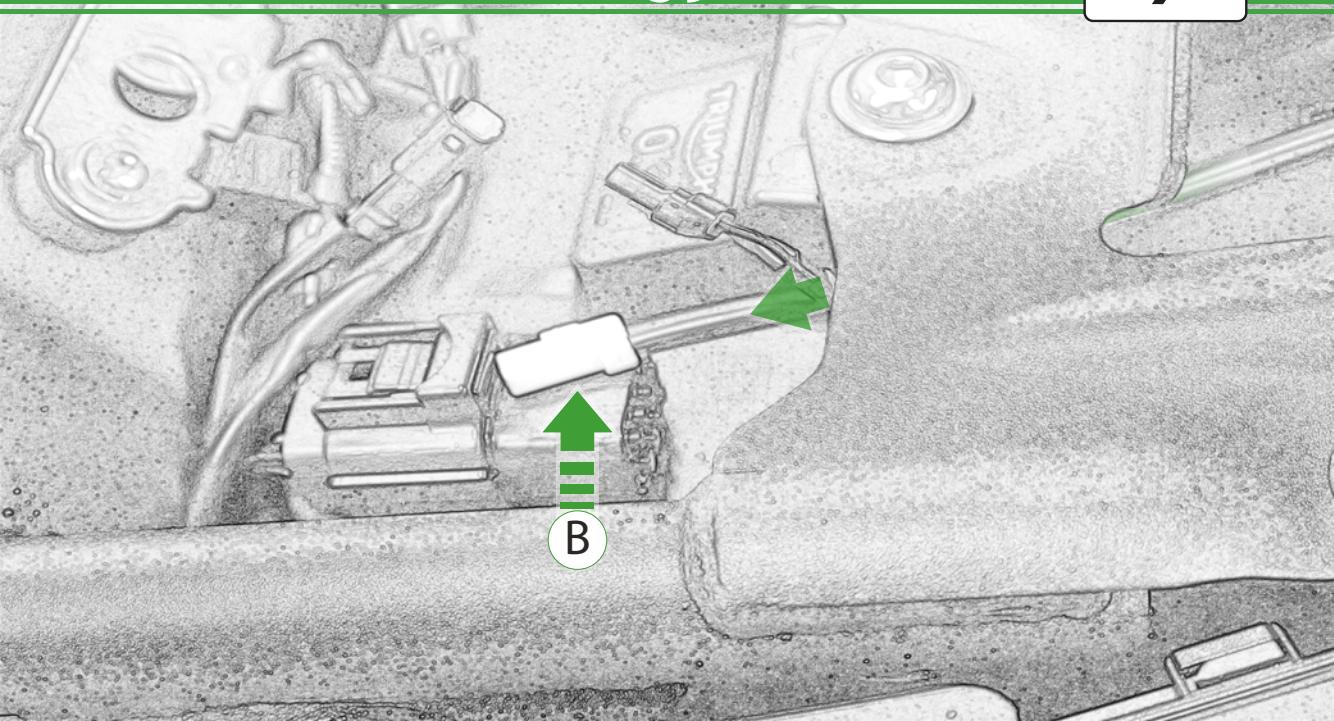

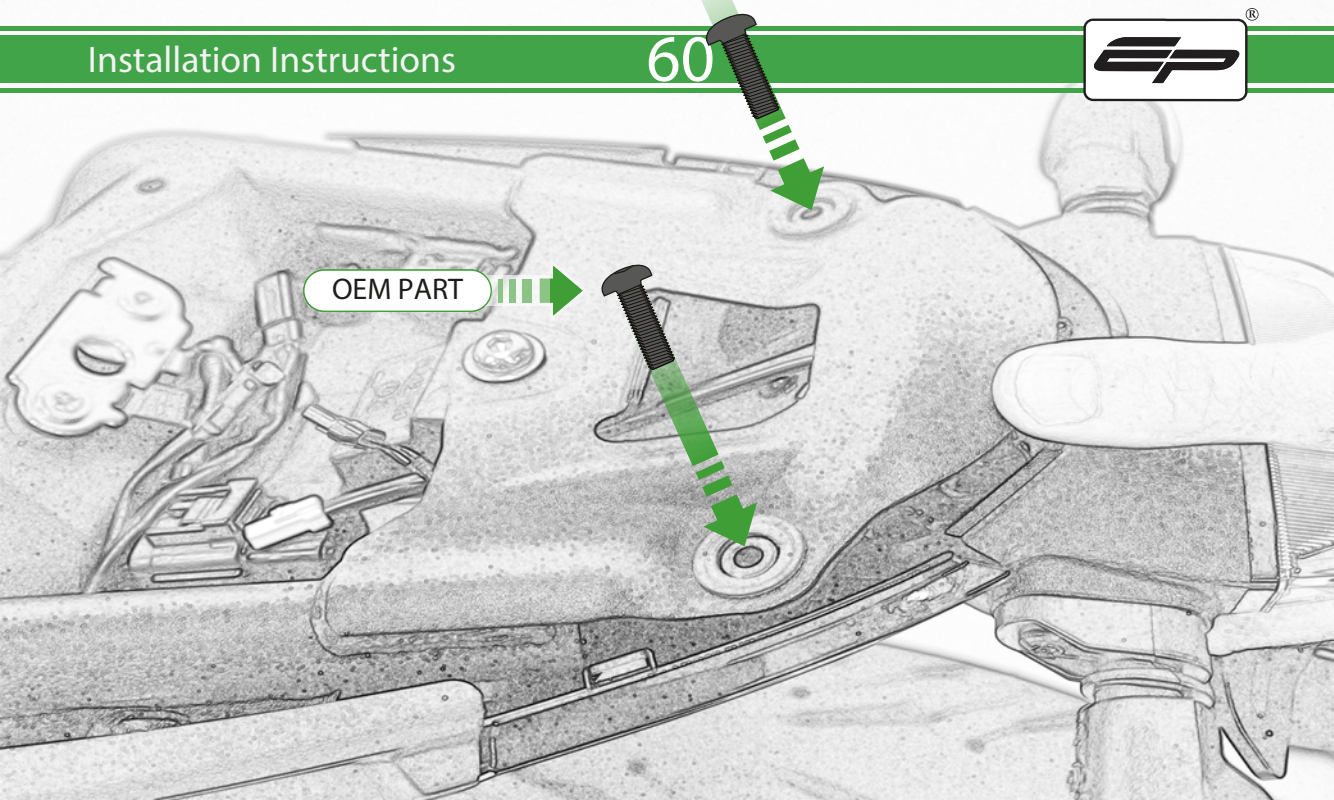

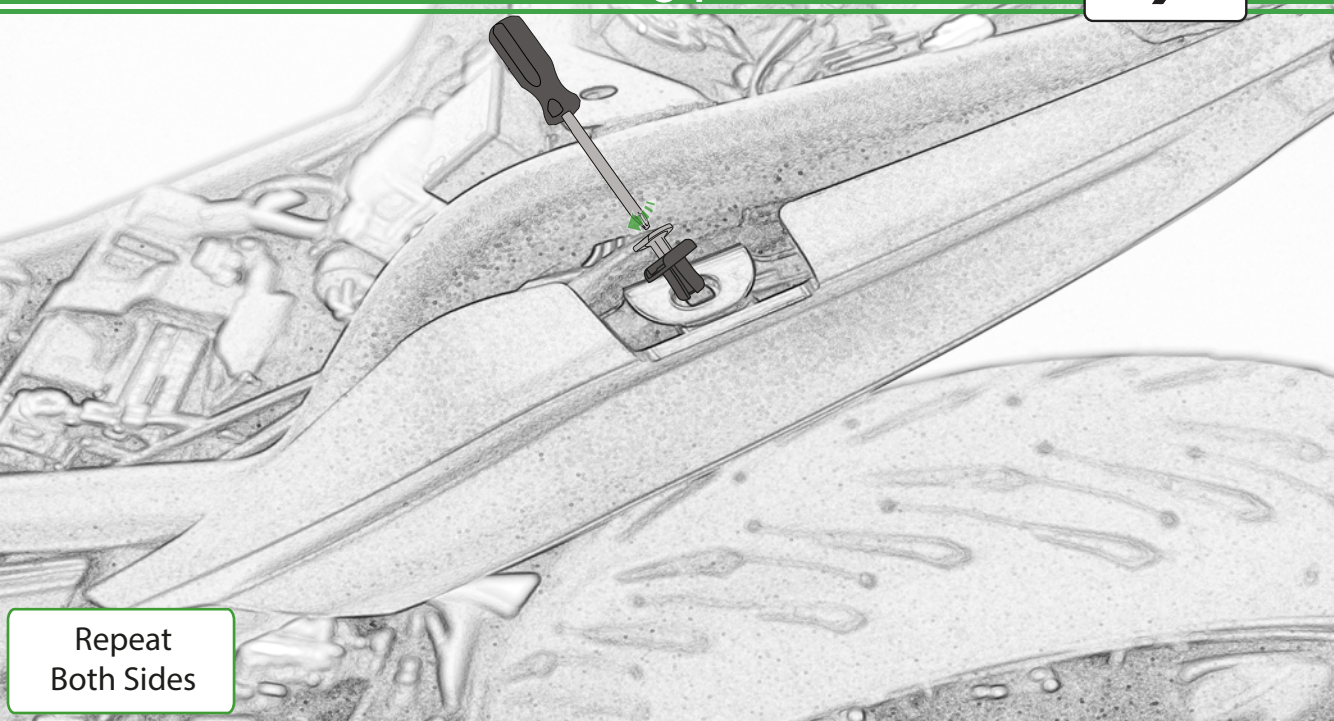

Repeat
Both Sides

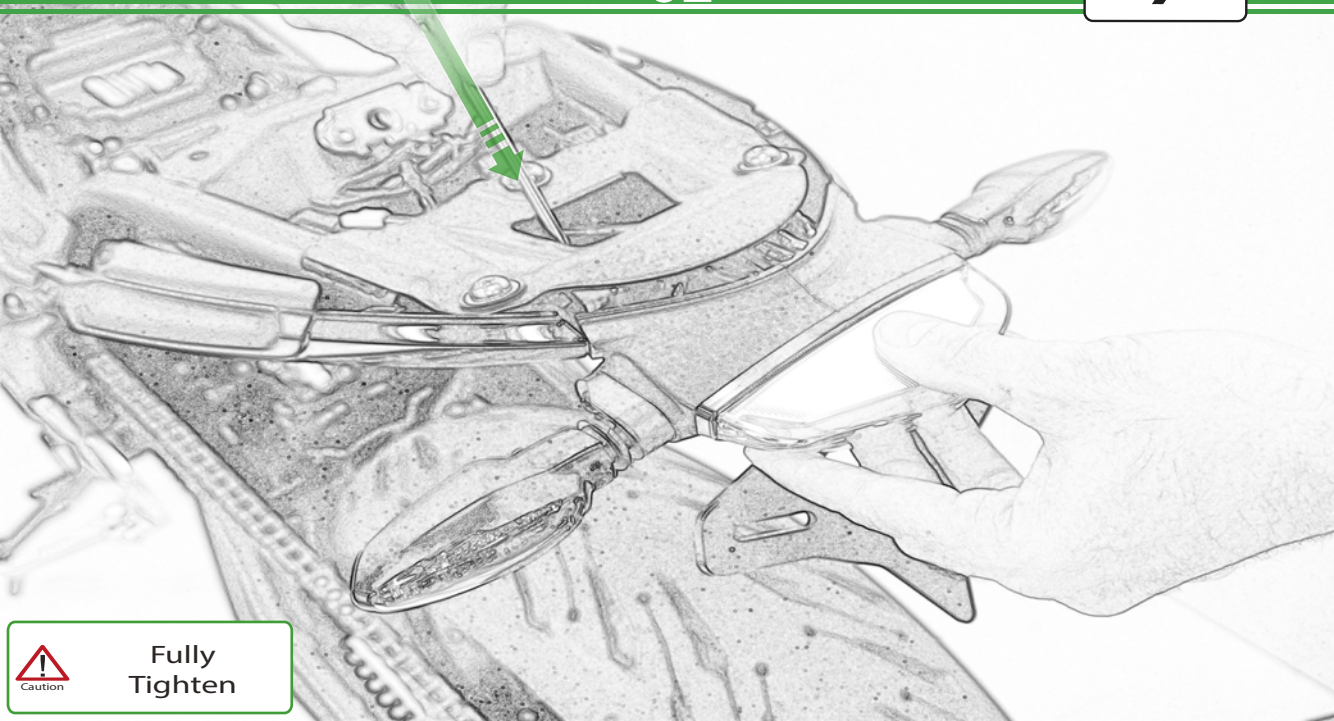

Fully
Tighten

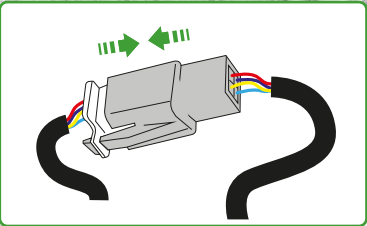
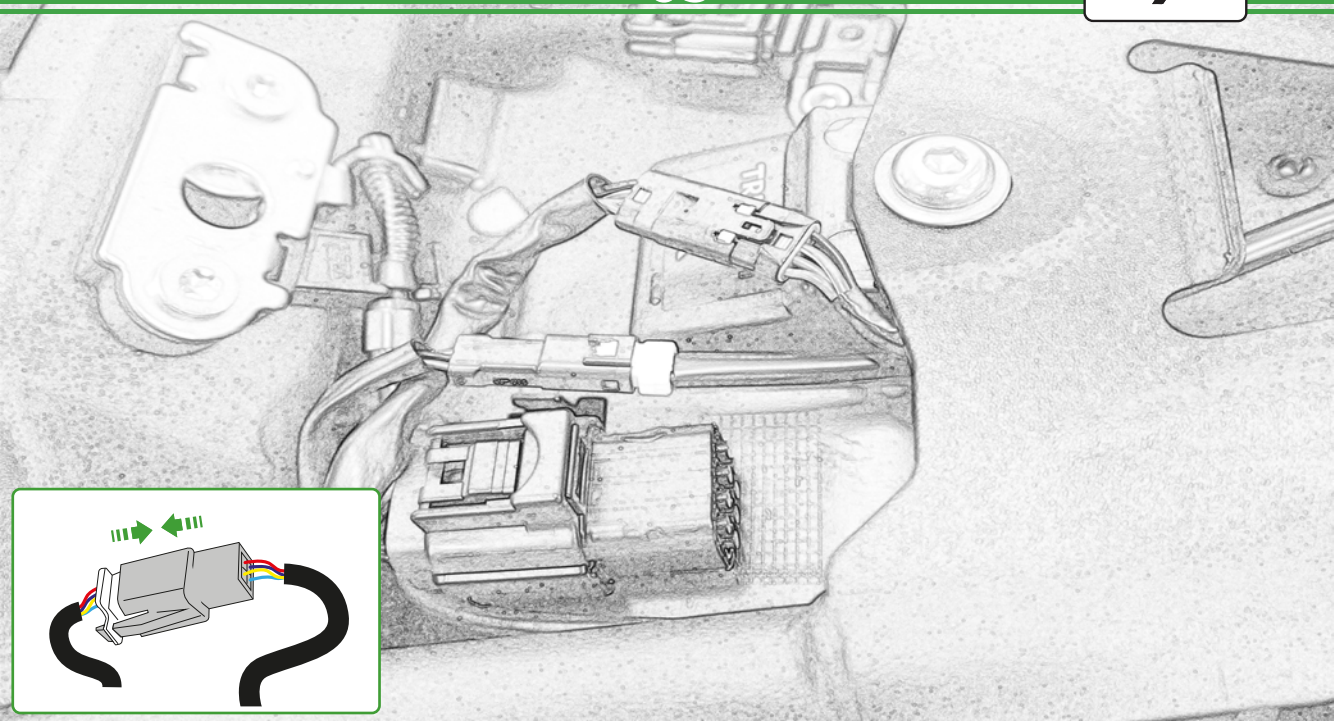



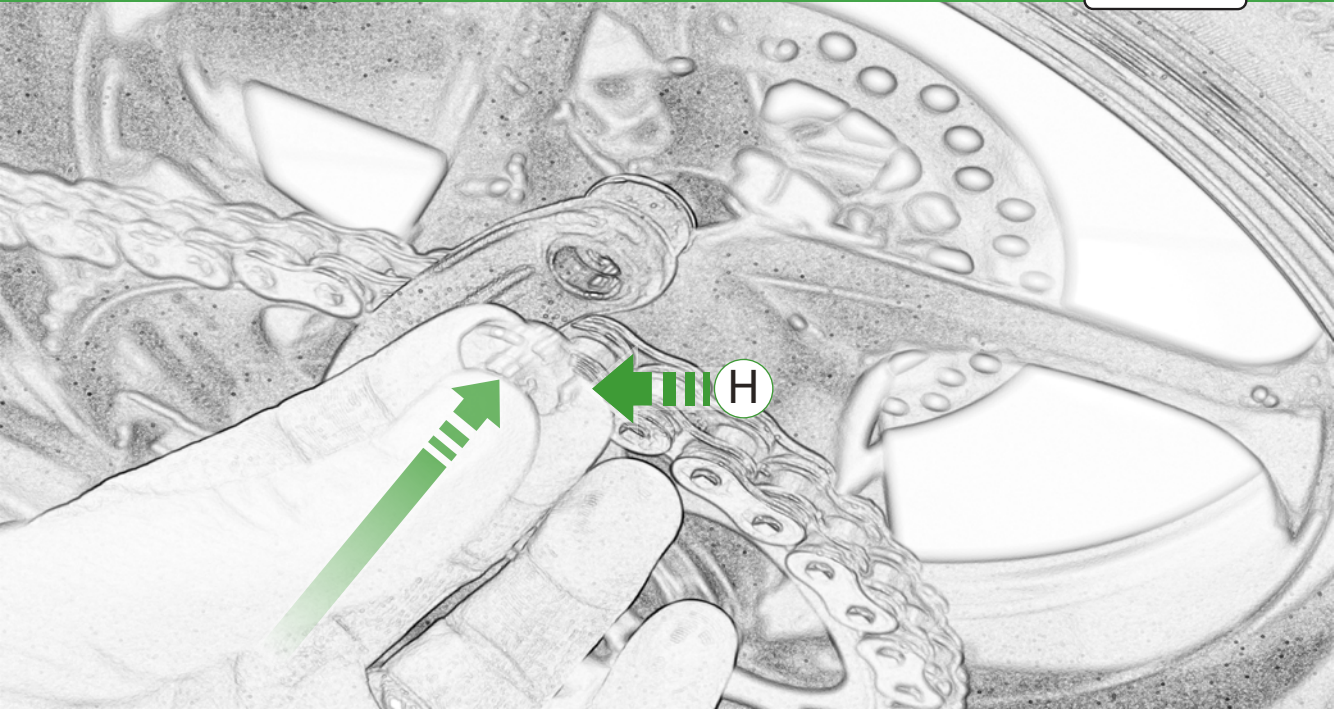

H

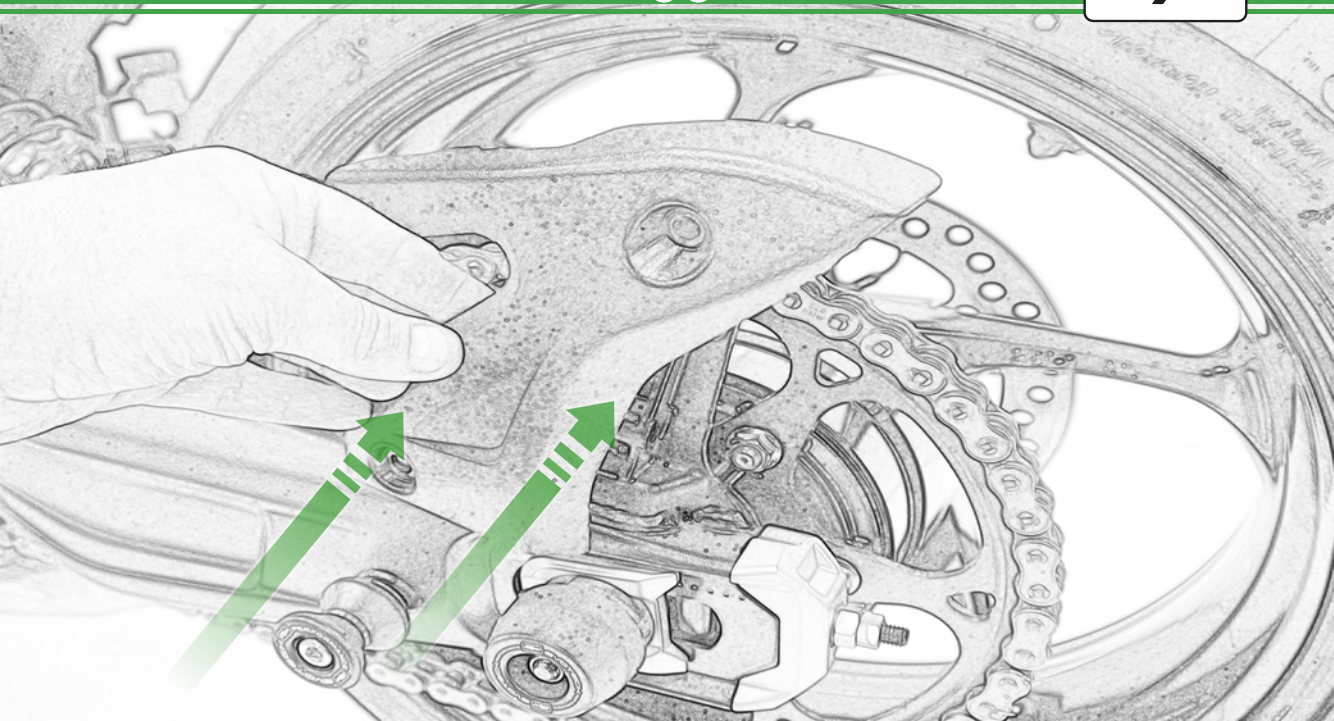

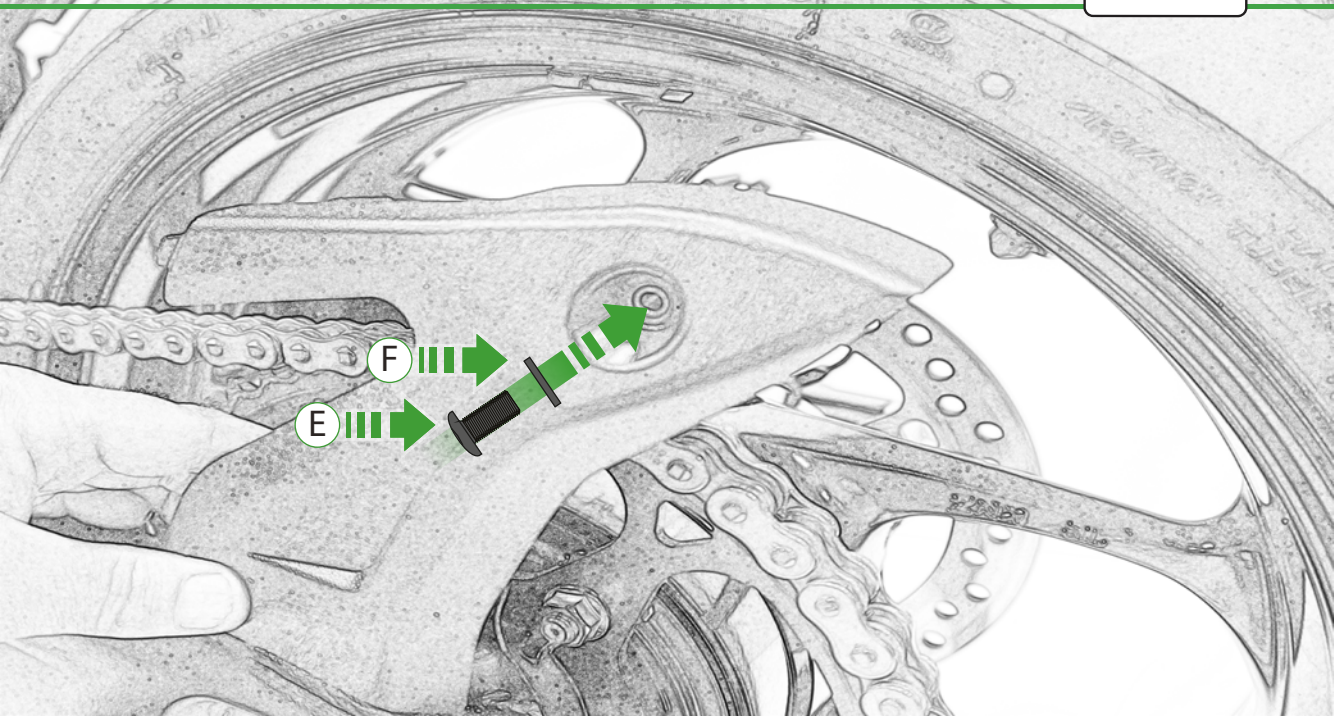

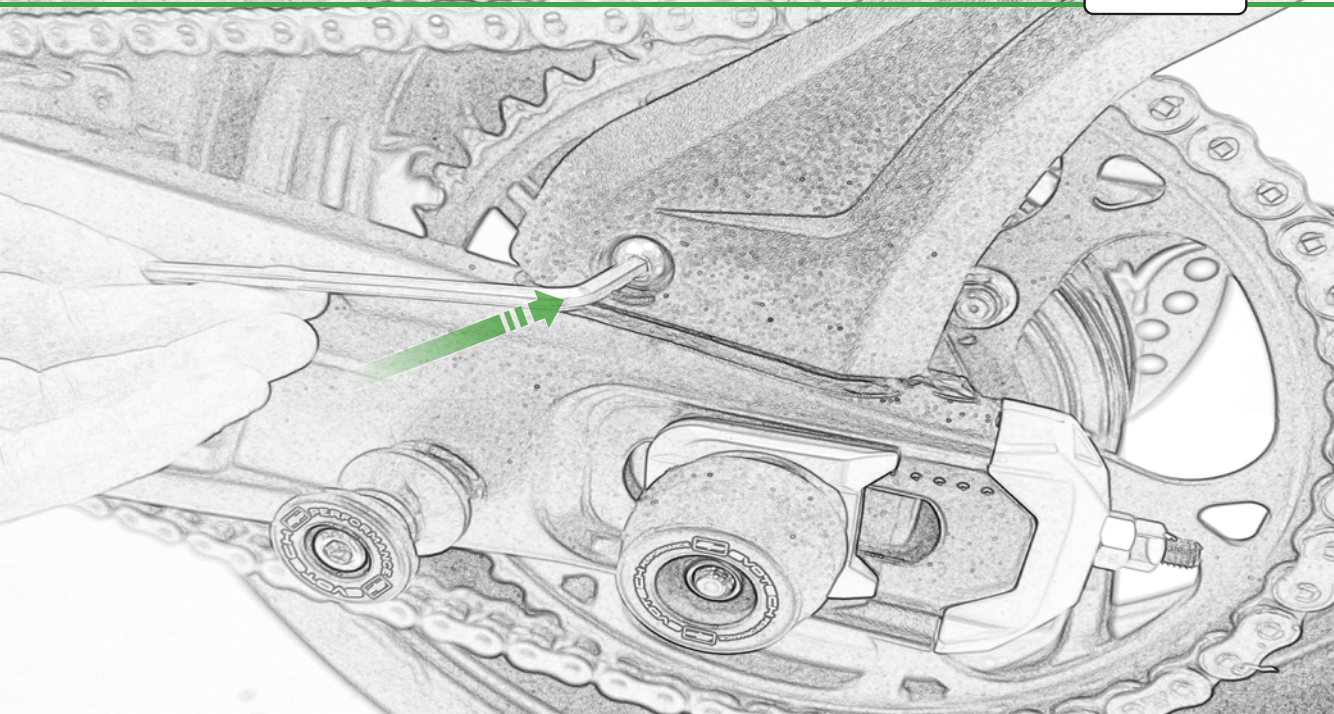

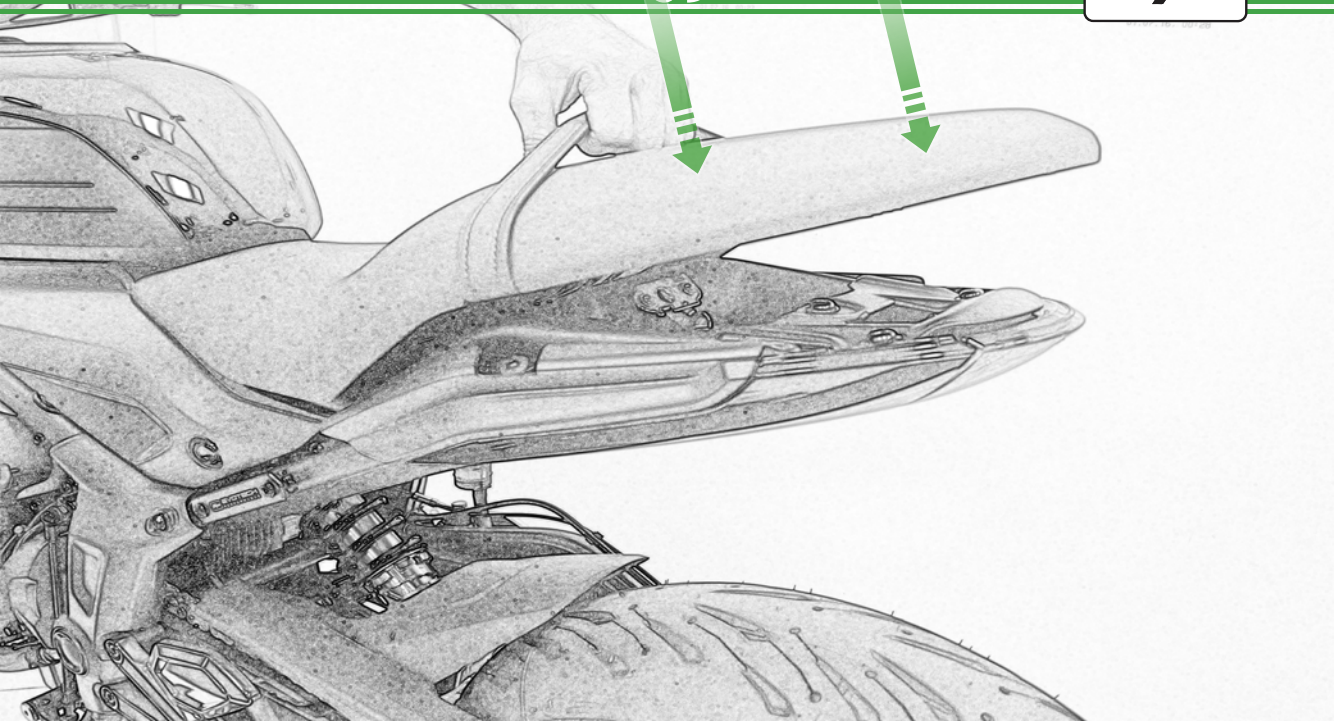



ESSENTIAL CHECKS



After installation of your tail tidy ensure that the licence plate does not contact the rear tyre when suspension is fully compressed.

Ensure all electrics including indicators, tail light, brake light and licence plate light lights are working correctly before riding the motorcycle.

It is recommended that periodic inspections are made to ensure that all fixings are fully tightend.

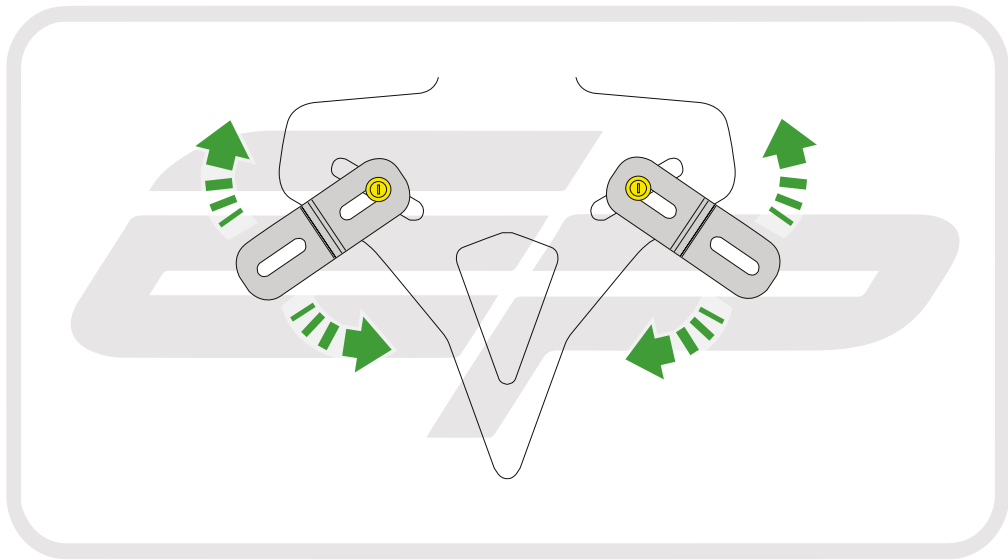

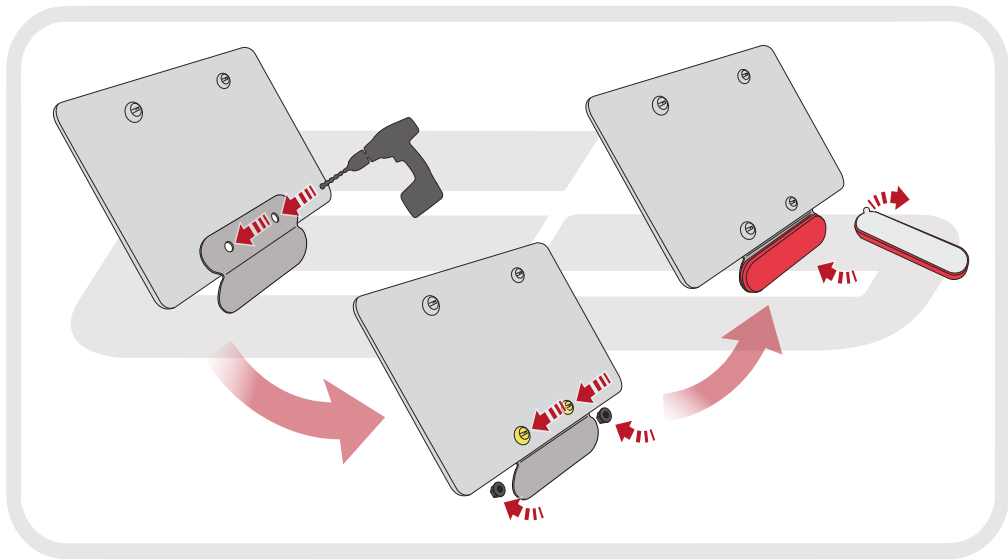



EVOTECH®
P E R F O R M A N C E

www.evotech-performance.com